

# User Manual



## **RSA2203A & RSA2208A 3 GHz & 8 GHz Real-Time Spectrum Analyzers 071-1334-03**

This document applies to firmware version 3.10  
and above.

[www.tektronix.com](http://www.tektronix.com)

Copyright © Tektronix, Inc. All rights reserved. Licensed software products are owned by Tektronix or its subsidiaries or suppliers, and are protected by national copyright laws and international treaty provisions.

Tektronix products are covered by U.S. and foreign patents, issued and pending. Information in this publication supercedes that in all previously published material. Specifications and price change privileges reserved.

TEKTRONIX and TEK are registered trademarks of Tektronix, Inc.

## **Contacting Tektronix**

Tektronix, Inc.  
14200 SW Karl Braun Drive  
P.O. Box 500  
Beaverton, OR 97077  
USA

For product information, sales, service, and technical support:

- In North America, call 1-800-833-9200.
- Worldwide, visit [www.tektronix.com](http://www.tektronix.com) to find contacts in your area.

## **End User License Agreement for Microsoft Software**

You have acquired a device (“DEVICE”) that includes software licensed by Tektronix Japan, Ltd. (“TJ”) from Microsoft Licensing Inc. or its affiliates (“MS”). Those installed software products of MS origin, as well as associated media, printed materials, and “online” or electronic documentation (“SOFTWARE”) are protected by international intellectual property laws and treaties. The SOFTWARE is licensed, not sold. All rights reserved.

**IF YOU DO NOT AGREE TO THIS END USER LICENSE AGREEMENT (“EULA”), DO NOT USE THE DEVICE OR COPY THE SOFTWARE. INSTEAD, PROMPTLY CONTACT TJ FOR INSTRUCTIONS ON RETURN OF THE UNUSED DEVICE(S) FOR A REFUND. ANY USE OF THE SOFTWARE, INCLUDING BUT NOT LIMITED TO USE ON THE DEVICE, WILL CONSTITUTE YOUR AGREEMENT TO THIS EULA (OR RATIFICATION OF ANY PREVIOUS CONSENT).**

**GRANT OF SOFTWARE LICENSE.** This EULA grants you the following license:

You may use the SOFTWARE only on the DEVICE.

### **NOT FAULT TOLERANT.**

THE SOFTWARE IS NOT FAULT TOLERANT. TJ HAS INDEPENDENTLY DETERMINED HOW TO USE THE SOFTWARE IN THE DEVICE, AND MS HAS RELIED UPON TJ TO CONDUCT SUFFICIENT TESTING TO DETERMINE THAT THE SOFTWARE IS SUITABLE FOR SUCH USE.

### **NO WARRANTIES FOR THE SOFTWARE.**

**THE SOFTWARE IS PROVIDED “AS IS” AND WITH ALL FAULTS. THE ENTIRE RISK AS TO SATISFACTORY QUALITY, PERFORMANCE, ACCURACY, AND EFFORT (INCLUDING LACK OF NEGLIGENCE) IS WITH YOU. ALSO, THERE IS NO WARRANTY AGAINST INTERFERENCE WITH YOUR ENJOYMENT OF THE SOFTWARE OR AGAINST INFRINGEMENT. IF YOU HAVE RECEIVED ANY WARRANTIES REGARDING THE DEVICE OR THE SOFTWARE, THOSE WARRANTIES DO NOT ORIGINATE FROM, AND ARE NOT BINDING ON, MS.**

### **NOTE ON JAVA SUPPORT.**

The SOFTWARE may contain support for programs written in Java. Java technology is not fault tolerant and is not designed, manufactured, or intended for use or resale as online control equipment in hazardous environments requiring fail-safe performance, such as in the operation of nuclear facilities, aircraft navigation or communication systems, air traffic control, direct life support machines, or weapons systems, in which the failure of Java technology could lead directly to death, personal injury, or severe physical or environmental damage. Sun Microsystems, Inc. has contractually obligated MS to make this disclaimer.

### **NO LIABILITY FOR CERTAIN DAMAGES.**

**EXCEPT AS PROHIBITED BY LAW, MS SHALL HAVE NO LIABILITY FOR ANY INDIRECT, SPECIAL, CONSEQUENTIAL OR INCIDENTAL DAMAGES ARISING FROM OR IN CONNECTION WITH THE USE OR PERFORMANCE OF THE SOFTWARE. THIS LIMITATION SHALL APPLY EVEN IF ANY REMEDY FAILS OF ITS ESSENTIAL PURPOSE. IN NO EVENT SHALL MS BE LIABLE FOR ANY AMOUNT IN EXCESS OF U.S. TWO HUNDRED FIFTY DOLLARS (U.S.\$250.00).**

**LIMITATIONS ON REVERSE ENGINEERING, DECOMPILATION, AND DISASSEMBLY.**

You may not reverse engineer, decompile, or disassemble the SOFTWARE, except and only to the extent that such activity is expressly permitted by applicable law notwithstanding this limitation.

**SOFTWARE TRANSFER ALLOWED BUT WITH RESTRICTIONS.**

You may permanently transfer rights under this EULA only as part of a permanent sale or transfer of the Device, and only if the recipient agrees to this EULA. If the SOFTWARE is an upgrade, any transfer must also include all prior versions of the SOFTWARE.

**EXPORT RESTRICTIONS.**

You acknowledge that SOFTWARE is of US-origin. You agree to comply with all applicable international and national laws that apply to the SOFTWARE, including the U.S. Export Administration Regulations, as well as end-user, end-use and country destination restrictions issued by U.S. and other governments. For additional information on exporting the SOFTWARE, see <http://www.microsoft.com/exporting/>.

**LIMITATION ON SOFTWARE PROGRAMS USED ON THE DEVICE.**

The combination of software programs you use on the DEVICE shall address not more than two (2) general office automation or consumer computing functions. Such functions include, but are not limited to: email, word processing, spreadsheets, database, network browsing, scheduling, and personal finance.

**STORAGE/NETWORK USE.**

The SOFTWARE may not be installed, accessed, displayed, run, shared or used concurrently on or from different computers, including a workstation, terminal or other digital electronic device ("Computing System"). Notwithstanding the foregoing and except as otherwise provided below, any number of Computing Systems, may access or otherwise utilize the file and print services and internet information services of the SOFTWARE, if included.

You may use the SOFTWARE on a single DEVICE as interactive workstation software, but not as server software. However, you may permit a maximum of ten (10) Computing Systems to connect to the DEVICE to access and use services of the SOFTWARE, such as file and print services and internet information services. The ten-connection maximum includes any indirect connections made through other software or hardware which pools or aggregates connections.

## Warranty 2

Tektronix warrants that this product will be free from defects in materials and workmanship for a period of one (1) year from the date of shipment. If any such product proves defective during this warranty period, Tektronix, at its option, either will repair the defective product without charge for parts and labor, or will provide a replacement in exchange for the defective product. Parts, modules and replacement products used by Tektronix for warranty work may be new or reconditioned to like new performance. All replaced parts, modules and products become the property of Tektronix.

In order to obtain service under this warranty, Customer must notify Tektronix of the defect before the expiration of the warranty period and make suitable arrangements for the performance of service. Customer shall be responsible for packaging and shipping the defective product to the service center designated by Tektronix, with shipping charges prepaid. Tektronix shall pay for the return of the product to Customer if the shipment is to a location within the country in which the Tektronix service center is located. Customer shall be responsible for paying all shipping charges, duties, taxes, and any other charges for products returned to any other locations.

This warranty shall not apply to any defect, failure or damage caused by improper use or improper or inadequate maintenance and care. Tektronix shall not be obligated to furnish service under this warranty a) to repair damage resulting from attempts by personnel other than Tektronix representatives to install, repair or service the product; b) to repair damage resulting from improper use or connection to incompatible equipment; c) to repair any damage or malfunction caused by the use of non-Tektronix supplies; or d) to service a product that has been modified or integrated with other products when the effect of such modification or integration increases the time or difficulty of servicing the product.

THIS WARRANTY IS GIVEN BY TEKTRONIX WITH RESPECT TO THE PRODUCT IN LIEU OF ANY OTHER WARRANTIES, EXPRESS OR IMPLIED. TEKTRONIX AND ITS VENDORS DISCLAIM ANY IMPLIED WARRANTIES OF MERCHANTABILITY OR FITNESS FOR A PARTICULAR PURPOSE. TEKTRONIX' RESPONSIBILITY TO REPAIR OR REPLACE DEFECTIVE PRODUCTS IS THE SOLE AND EXCLUSIVE REMEDY PROVIDED TO THE CUSTOMER FOR BREACH OF THIS WARRANTY. TEKTRONIX AND ITS VENDORS WILL NOT BE LIABLE FOR ANY INDIRECT, SPECIAL, INCIDENTAL, OR CONSEQUENTIAL DAMAGES IRRESPECTIVE OF WHETHER TEKTRONIX OR THE VENDOR HAS ADVANCE NOTICE OF THE POSSIBILITY OF SUCH DAMAGES.



## Service Options

Tektronix provides service to cover repair under warranty as well as other services that are designed to meet your specific service needs. Advancing technology has brought incredible change to the power of measurement instruments. Manufacturing methods and calibration techniques have been revolutionized, making the service challenge tougher than ever. By using Tektronix as your service provider you make use of our technology and product knowledge, our world-wide logistics infrastructure, and our ISO9000 approved service centers. Tektronix technicians are trained on the latest products and are equipped with the most current information on product improvements and upgrades for optimum product performance.

**Warranty Repair Service.** Tektronix technicians provide warranty service at most Tektronix service locations worldwide. The warranty period for this product can be found behind the title page in this manual.

**Calibration and Repair Service.** Tektronix offers calibrations, non-warranty repair, and support for customers performing their own service. Where appropriate, calibrations are compliant to ANSI/NCSL Z-540/ISO17025 and ISO9000 Quality Systems. If you prefer to perform your own service, Tektronix supports repair to the replaceable-part level through providing for circuit board exchange. All services can be purchased through a variety of agreements to fit your specific requirements.

For more information regarding service offerings or service locations worldwide, please see the Tektronix product catalog or visit us on our Customer Services World Center web site at:

<http://www.tek.com/Measurement/Service>.





# Table of Contents

<b>General Safety Summary</b> .....	<b>xiii</b>
<b>Preface</b> .....	<b>xv</b>
About This Manual .....	xv
Related Documents .....	xvi
Conventions .....	xvi

## Getting Started

<b>Product Overview</b> .....	<b>1-1</b>
Features .....	1-1
Application .....	1-2
Difference between RSA2203A and RSA2208A .....	1-2
Real-Time Analysis .....	1-3
Architecture .....	1-6
<b>Installation</b> .....	<b>1-9</b>
Unpacking to Check Contents .....	1-9
Applying Power .....	1-10
Setting Up the Stand .....	1-13
Functional Check .....	1-14
Powering Off the Analyzer .....	1-18
Restart .....	1-19
Backing Up User Files .....	1-20
About Installation of Other Applications .....	1-20
<b>Calibration</b> .....	<b>1-21</b>
Cal Menu .....	1-22
Calibrating Gain .....	1-23
Calibrating Center Offset .....	1-24
Calibrating DC Offset (Option 05 Only) .....	1-25
Adjusting Display Brightness .....	1-26
Confirming Performance .....	1-26

## Operating Basics

<b>Interface Maps</b> .....	<b>2-1</b>
Controls and Connectors .....	2-2
Display Screen .....	2-8
<b>Functional Overview</b> .....	<b>2-13</b>
Menu Keys .....	2-13
Menu Operations .....	2-16
Measurement Basics .....	2-21
Setting System Parameters .....	2-23
Using Windows XP .....	2-26

<b>Tutorial</b> .....	<b>2-29</b>
Preparations .....	2-30
Displaying Spectrum .....	2-34
Using Markers and Peak Search .....	2-41
Using Averaging and Comparison Displays .....	2-46
Displaying a Spectrogram .....	2-49
Spectrum Analysis .....	2-52
Analog Modulation Analysis .....	2-56
Turning Off the Power .....	2-64

## Reference

<b>Spectrum Analysis (S/A Mode)</b> .....	<b>3-1</b>
Measurement Screen Layout .....	3-2
Spectrum Analysis .....	3-4
Spectrogram Display .....	3-18
Real-Time Analysis .....	3-20
Zoom Function .....	3-24
<b>Modulation Analysis (Demod Mode)</b> .....	<b>3-27</b>
Measurement Screen Layout .....	3-28
Analog Modulation Analysis .....	3-34
<b>Time Analysis (Time Mode)</b> .....	<b>3-43</b>
Measurement Screen Layout .....	3-43
Time Variation Measurement .....	3-44
CCDF Measurement .....	3-48
Pulse Measurements .....	3-53
<b>Setting Frequency and Span</b> .....	<b>3-63</b>
Frequency and Span Setting Menu .....	3-64
Using the Channel Table .....	3-66
Using the Marker and Peak Search .....	3-67
Frequency Setting Range .....	3-68
Vector Span .....	3-70
<b>Setting Amplitude</b> .....	<b>3-71</b>
Amplitude Menu .....	3-71
Over-Voltage Input .....	3-75
Amplitude Correction .....	3-76
<b>Setting Timing Parameters</b> .....	<b>3-85</b>
Timing Menu .....	3-85
Seamless Acquisition .....	3-89
<b>Trigger</b> .....	<b>3-91</b>
Trigger Menu .....	3-92
IF Trigger .....	3-98
Trigger Point Indicator .....	3-101
<b>FFT and RBW</b> .....	<b>3-103</b>
RBW/FFT Menu .....	3-104
FFT Points .....	3-107
FFT Window .....	3-108

---

<b>Trace Comparison Display and Average Function</b> .....	<b>3-113</b>
Trace/Avg Menu .....	3-114
Displaying Trace 1 and 2 .....	3-116
Averaging the Waveform .....	3-117
Saving/Loading Waveform Data .....	3-120
Trace Compression .....	3-120
<b>Setting Views</b> .....	<b>3-123</b>
View Menu .....	3-123
Basic Procedure .....	3-124
Spectrum View Setting .....	3-125
Spectrogram View Setting .....	3-126
Time Domain View Setting .....	3-128
CCDF View Setting .....	3-130
<b>Display Line</b> .....	<b>3-131</b>
Display Line Operation (Other than Real Time S/A) .....	3-132
Multi Display Lines (Real Time S/A Only) .....	3-135
<b>Marker Operation and Peak Search</b> .....	<b>3-139</b>
Markers Menu .....	3-140
Using Markers .....	3-143
Peak Search .....	3-148
<b>Using the Online Help</b> .....	<b>3-151</b>
Displaying the Online Help .....	3-151
Using a Mouse and Keyboard .....	3-154
<b>Selecting Input Source</b> .....	<b>3-155</b>
Input Menu .....	3-155
<b>File Operations</b> .....	<b>3-157</b>
File Type .....	3-157
Load/Save Menu .....	3-158
Saving and Loading Files .....	3-160
Entering a File Name .....	3-166
Deleting a File .....	3-168
Making/Deleting a Directory .....	3-168
<b>File Format</b> .....	<b>3-169</b>
Data File Format .....	3-169
Trace File Format .....	3-177
<b>Screen Copy</b> .....	<b>3-181</b>
Print Menu .....	3-181
Printing a Screen Copy .....	3-182
Creating a File .....	3-183

## Appendices

<b>Appendix A: Specifications</b> .....	<b>A-1</b>
Electrical Characteristics .....	A-2
Physical Characteristics .....	A-13
Environmental Characteristics .....	A-13
<b>Appendix B: Menu Tree</b> .....	<b>B-1</b>
<b>Appendix C: Default Settings</b> .....	<b>C-1</b>
<b>Appendix D: Inspection and Cleaning</b> .....	<b>D-1</b>
Inspecting the Exterior .....	D-1
Cleaning the Exterior .....	D-2
Lubrication .....	D-2
Cleaning the Interior .....	D-2
<b>Appendix E: Options and Accessories</b> .....	<b>E-1</b>
Options .....	E-1
Standard Accessories .....	E-3
Optional Accessories .....	E-3

## Glossary

## Index

# List of Figures

Figure 1–1: Concept of the swept spectrum analyzer .....	1–3
Figure 1–2: Sweep of resolution filter .....	1–3
Figure 1–3: Concept of the real-time spectrum analyzer .....	1–4
Figure 1–4: Concurrent acquisition .....	1–4
Figure 1–5: Frame acquisition .....	1–5
Figure 1–6: Block diagram .....	1–6
Figure 1–7: AC Input (rear panel) .....	1–10
Figure 1–8: Principal power switch (rear panel) .....	1–11
Figure 1–9: Front panel power switch (ON/STANDBY switch) .....	1–11
Figure 1–10: Initial screen .....	1–12
Figure 1–11: RF INPUT connector .....	1–12
Figure 1–12: Setting up the stand .....	1–13
Figure 1–13: Spectrum of the calibration signal (50 MHz, about –20 dBm) .....	1–14
Figure 1–14: Setup display .....	1–15
Figure 1–15: Reference level setting and A/D overflow indicator ...	1–16
Figure 1–16: Spectrogram display .....	1–17
Figure 1–17: Calibration menu structure .....	1–22
Figure 1–18: UNCAL display .....	1–23
Figure 1–19: Center offset .....	1–24
Figure 1–20: DC offset .....	1–25
Figure 1–21: System menu .....	1–26
Figure 2–1: Front panel .....	2–2
Figure 2–2: Rear panel .....	2–4
Figure 2–3: Side panel .....	2–5
Figure 2–4: Connecting USB devices .....	2–6
Figure 2–5: Operation with mouse and keyboard .....	2–7
Figure 2–6: Display screen configuration .....	2–8
Figure 2–7: Status display .....	2–10
Figure 2–8: Pre- and post-trigger regions .....	2–10
Figure 2–9: Key lock display .....	2–11
Figure 2–10: Setup display .....	2–12
Figure 2–11: Menu keys .....	2–14
Figure 2–12: Example menu item display .....	2–16

Figure 2–13: Menu item types .....	2–17
Figure 2–14: Numeric setting menu .....	2–17
Figure 2–15: Changing value with the knob .....	2–18
Figure 2–16: Changing value with the keypad .....	2–19
Figure 2–17: Numeric keypad .....	2–19
Figure 2–18: Changing the step size for the center frequency .....	2–20
Figure 2–19: Changing the step size for the center frequency .....	2–20
Figure 2–20: Selecting the measurement mode .....	2–21
Figure 2–21: Starting/Stopping data acquisition .....	2–22
Figure 2–22: Restoring default settings .....	2–22
Figure 2–23: System menu .....	2–23
Figure 2–24: Displaying versions and options .....	2–24
Figure 2–25: Displaying the Windows XP accessory menu .....	2–27
Figure 2–26: Cable connection .....	2–30
Figure 2–27: Principal power switch (rear panel) .....	2–31
Figure 2–28: Power switch (ON/STANDBY) .....	2–31
Figure 2–29: Initial screen .....	2–32
Figure 2–30: Frequency, span, and amplitude settings .....	2–34
Figure 2–31: Menu items for numeric value input .....	2–35
Figure 2–32: Numeric value entry keypad .....	2–35
Figure 2–33: Center frequency of 100 MHz, span of 10 MHz .....	2–36
Figure 2–34: Center frequency of 100 MHz, span of 20 kHz .....	2–37
Figure 2–35: Setting amplitude .....	2–38
Figure 2–36: Menu items for numeric value input .....	2–39
Figure 2–37: Reference level of 10 dBm .....	2–39
Figure 2–38: Status indicator .....	2–40
Figure 2–39: Measurement with a single marker .....	2–42
Figure 2–40: Measurement with the delta marker .....	2–43
Figure 2–41: Searching for the peak .....	2–45
Figure 2–42: Comparing a new waveform with an averaged waveform .....	2–47
Figure 2–43: Comparison display with averaged waveform .....	2–48
Figure 2–44: Concurrent display of spectrum and spectrogram ....	2–49
Figure 2–45: Tall display of spectrum and spectrogram .....	2–50
Figure 2–46: Spectrogram view .....	2–51
Figure 2–47: Channel power measurement .....	2–53
Figure 2–48: Channel power measurement (Channel Bandwidth = 40 kHz) .....	2–54
Figure 2–49: Carrier frequency measurement .....	2–55

Figure 2–50: MODE keys .....	2–56
Figure 2–51: AM signal measurement .....	2–57
Figure 2–52: Analysis range settings .....	2–59
Figure 2–53: Frame and block .....	2–60
Figure 2–54: Changing the acquisition length .....	2–61
Figure 2–55: Single view display .....	2–62
Figure 2–56: Scale settings .....	2–63
Figure 3–1: S/A menu structure .....	3–1
Figure 3–2: S/A measurement screen .....	3–2
Figure 3–3: “Flex” grid style .....	3–3
Figure 3–4: Channel power measurement band power markers ....	3–5
Figure 3–5: Channel power measurement .....	3–6
Figure 3–6: ACPR measurement band power markers .....	3–7
Figure 3–7: Example of ACPR measurement .....	3–8
Figure 3–8: C/N measurement band power markers .....	3–9
Figure 3–9: Example of C/N measurement .....	3–10
Figure 3–10: OBW measurement band power marker .....	3–11
Figure 3–11: Example of OBW measurement .....	3–12
Figure 3–12: Carrier frequency measurement .....	3–13
Figure 3–13: EBW measurement band power markers .....	3–14
Figure 3–14: EBW measurement .....	3–15
Figure 3–15: Setting up spurious signal measurement .....	3–16
Figure 3–16: Example of spurious signal measurement .....	3–17
Figure 3–17: Spectrum and spectrogram concurrent display .....	3–18
Figure 3–18: View orientation .....	3–19
Figure 3–19: Single display .....	3–19
Figure 3–20: Difference between normal and real-time modes ....	3–20
Figure 3–21: Real-time mode .....	3–23
Figure 3–22: Zoom function .....	3–24
Figure 3–23: Zoom domain settings using the Timing menu .....	3–25
Figure 3–24: Zoomed area settings using the marker .....	3–26
Figure 3–25: Demod menu structure .....	3–27
Figure 3–26: Demod mode screen .....	3–28
Figure 3–27: Analysis range setting in the overview .....	3–29
Figure 3–28: MARKERS keys .....	3–30
Figure 3–29: Specifying the range with the marker and the reference cursor .....	3–31
Figure 3–30: FFT processing range setting on the overview .....	3–31

Figure 3–31: Changing the overview .....	3–32
Figure 3–32: One-view display .....	3–33
Figure 3–33: AM demod measurement .....	3–36
Figure 3–34: FM demod measurement .....	3–38
Figure 3–35: PM demod measurement .....	3–39
Figure 3–36: IQ versus time measurement .....	3–40
Figure 3–37: Pulse spectrum measurement .....	3–41
Figure 3–38: Time menu structure .....	3–43
Figure 3–39: IQ versus Time measurement .....	3–45
Figure 3–40: Power variance measurement .....	3–46
Figure 3–41: Frequency measurement .....	3–47
Figure 3–42: CCDF calculation process .....	3–48
Figure 3–43: CCDF single view .....	3–51
Figure 3–44: CCDF multi-view .....	3–52
Figure 3–45: Definition of pulse characteristics .....	3–54
Figure 3–46: Definition of pulse-on/off .....	3–54
Figure 3–47: Setting for View Results For... .....	3–58
Figure 3–48: Setting the View Define menu .....	3–59
Figure 3–49: Waveform display in the subview .....	3–62
Figure 3–50: Setting frequency and span .....	3–65
Figure 3–51: Setting the center frequency using MARKER ➡ .....	3–67
Figure 3–52: Relationship between the frequency and span settings .	3–69
Figure 3–53: Vector mode and scalar mode .....	3–70
Figure 3–54: Amplitude menu structure .....	3–71
Figure 3–55: Setting the amplitude .....	3–72
Figure 3–56: A/D overflow indicator .....	3–75
Figure 3–57: The amplitude correction concept .....	3–76
Figure 3–58: Amplitude correction example .....	3–78
Figure 3–59: Amplitude correction data input .....	3–81
Figure 3–60: Amplitude offset .....	3–83
Figure 3–61: Frequency offset .....	3–83
Figure 3–62: Amplitude correction setup display .....	3–84
Figure 3–63: Timing menu structure .....	3–85
Figure 3–64: Timing parameters .....	3–87
Figure 3–65: Timing parameters in the zoom mode .....	3–88
Figure 3–66: Frame cycle .....	3–89
Figure 3–67: Seamless acquisition .....	3–89
Figure 3–68: Trigger menu structure .....	3–92



Figure 3–69: Trigger level and slope .....	3–95
Figure 3–70: Trigger position .....	3–95
Figure 3–71: Acquiring and displaying data by Trigger and Repeat modes .....	3–96
Figure 3–72: Trigger level vs. Amplitude (reference level = +3 dBm)	3–98
Figure 3–73: Waveforms in time domain and in frequency domain .	3–99
Figure 3–74: IF trigger detection range .....	3–100
Figure 3–75: Trigger point display .....	3–101
Figure 3–76: FFT and RBW process .....	3–103
Figure 3–77: RBW/FFT menu tree .....	3–104
Figure 3–78: Process flow when RBW/FFT = FFT .....	3–105
Figure 3–79: FFT overlap .....	3–106
Figure 3–80: Generating spurious signals by increasing the number of FFT points .....	3–107
Figure 3–81: Windowing process of time domain data .....	3–109
Figure 3–82: Comparison display of Trace 1 and 2 .....	3–113
Figure 3–83: RBW/FFT menu structure .....	3–114
Figure 3–84: Displaying an averaged waveform .....	3–118
Figure 3–85: Compared display .....	3–119
Figure 3–86: Relationships between frame, bin, and pixel .....	3–121
Figure 3–87: Compression method for displaying the waveform ....	3–122
Figure 3–88: View keys .....	3–123
Figure 3–89: Setting the scale in spectrum view .....	3–125
Figure 3–90: Scale and format settings in spectrogram view .....	3–127
Figure 3–91: Setting the scale in time domain view .....	3–129
Figure 3–92: Setting the scale in CCDF view .....	3–130
Figure 3–93: Display line .....	3–131
Figure 3–94: Lines menu structure (other than Real Time S/A) ....	3–132
Figure 3–95: Two horizontal lines .....	3–133
Figure 3–96: Two horizontal and two vertical lines .....	3–134
Figure 3–97: Multi display lines (Real Time S/A mode) .....	3–135
Figure 3–98: Lines menu structure (Real Time S/A) .....	3–136
Figure 3–99: Marker display .....	3–139
Figure 3–100: Markers menu structure .....	3–140
Figure 3–101: Measurement with a single marker .....	3–143
Figure 3–102: Using the delta marker to take measurements .....	3–144
Figure 3–103: Measurement with the reference cursor .....	3–145
Figure 3–104: Changing the Trace .....	3–146
Figure 3–105: Interlocked markers .....	3–147

<b>Figure 3–106: Functions of the peak search keys</b> .....	<b>3–148</b>
<b>Figure 3–107: Setting the minimum frequency jump</b> .....	<b>3–149</b>
<b>Figure 3–108: Online help for the front panel key</b> .....	<b>3–152</b>
<b>Figure 3–109: Online user manual</b> .....	<b>3–153</b>
<b>Figure 3–110: Word search using the keyboard</b> .....	<b>3–154</b>
<b>Figure 3–111: Input menu tree</b> .....	<b>3–155</b>
<b>Figure 3–112: Load/Save menu structure</b> .....	<b>3–158</b>
<b>Figure 3–113: Save to the preset file (lower right of the screen)</b> .....	<b>3–161</b>
<b>Figure 3–114: Selecting the folder</b> .....	<b>3–162</b>
<b>Figure 3–115: Save to File menu</b> .....	<b>3–163</b>
<b>Figure 3–116: Load from the preset file (lower right of the screen)</b> ..	<b>3–164</b>
<b>Figure 3–117: Load from File menu</b> .....	<b>3–165</b>
<b>Figure 3–118: Alphanumeric keypad</b> .....	<b>3–166</b>
<b>Figure 3–119: Data file structure</b> .....	<b>3–169</b>
<b>Figure 3–120: Adding dummy frames</b> .....	<b>3–171</b>
<b>Figure 3–121: Data block</b> .....	<b>3–173</b>
<b>Figure 3–122: Trace file structure</b> .....	<b>3–177</b>
<b>Figure 3–123: Trace file example</b> .....	<b>3–177</b>
<b>Figure 3–124: Data block</b> .....	<b>3–179</b>
<b>Figure 3–125: Print menu structure</b> .....	<b>3–181</b>
<b>Figure B–1: Menu keys</b> .....	<b>B–1</b>

# List of Tables

Table 1–1: Span and RBW .....	1–15
Table 2–1: Key functions of the keyboard .....	2–7
Table 2–2: Status display .....	2–10
Table 2–3: Setup display .....	2–12
Table 2–4: Menu key summary .....	2–14
Table 2–5: Measurement modes .....	2–21
Table 3–1: Measurement items in the S/A mode .....	3–4
Table 3–2: Features of the real-time mode .....	3–21
Table 3–3: Span setting range .....	3–21
Table 3–4: Frequency and span setting range .....	3–68
Table 3–5: Reference level setting range .....	3–72
Table 3–6: RF attenuation level setting .....	3–73
Table 3–7: Mixer level setting .....	3–73
Table 3–8: Vertical scale setting range .....	3–74
Table 3–9: How to acquire a waveform .....	3–93
Table 3–10: Characteristics and usage of FFT windows .....	3–108
Table 3–11: FFT window and bandpass filter .....	3–110
Table 3–12: Averaging method .....	3–115
Table 3–13: Number of bins (FFT points: 1024) .....	3–120
Table 3–14: Front panel keys for online help .....	3–153
Table 3–15: File save operation .....	3–160
Table 3–16: Preset file names .....	3–161
Table 3–17: File load operation .....	3–164
Table 3–18: Combinations of valid A, P, I and Q .....	3–174
Table A–1: Frequency .....	A–2
Table A–2: Spectrum purity .....	A–3
Table A–3: Noise sideband .....	A–3
Table A–4: Input .....	A–4
Table A–5: Amplitude .....	A–5
Table A–6: Dynamic range .....	A–5
Table A–7: Spurious response .....	A–6
Table A–8: Acquisition .....	A–7
Table A–9: Sampling rate .....	A–7

<b>Table A-10: Frame time</b> .....	<b>A-8</b>
<b>Table A-11: RBW (Resolution Bandwidth)</b> .....	<b>A-9</b>
<b>Table A-12: Analog demodulation</b> .....	<b>A-9</b>
<b>Table A-13: Trigger</b> .....	<b>A-10</b>
<b>Table A-14: Measurement function</b> .....	<b>A-10</b>
<b>Table A-15: Display</b> .....	<b>A-10</b>
<b>Table A-16: Marker, trace, and display line</b> .....	<b>A-11</b>
<b>Table A-17: Controller and interface</b> .....	<b>A-11</b>
<b>Table A-18: Power requirements</b> .....	<b>A-12</b>
<b>Table A-19: Power connector</b> .....	<b>A-12</b>
<b>Table A-20: Physical characteristics</b> .....	<b>A-13</b>
<b>Table A-21: Environmental characteristics</b> .....	<b>A-13</b>
<b>Table A-22: Certifications and compliances</b> .....	<b>A-14</b>
<b>Table C-1: Measurement menu</b> .....	<b>C-2</b>
<b>Table C-2: Display menu</b> .....	<b>C-4</b>
<b>Table C-3: Utility menu</b> .....	<b>C-4</b>
<b>Table D-1: External inspection check list</b> .....	<b>D-1</b>
<b>Table E-1: Power cord identification</b> .....	<b>E-2</b>
<b>Table E-2: Standard accessories</b> .....	<b>E-3</b>
<b>Table E-3: Optional accessories</b> .....	<b>E-3</b>

# General Safety Summary

Review the following safety precautions to avoid injury and prevent damage to this product or any products connected to it. To avoid potential hazards, use this product only as specified.

*Only qualified personnel should perform service procedures.*

## To Avoid Fire or Personal Injury

**Use Proper Power Cord.** Use only the power cord specified for this product and certified for the country of use.

**Connect and Disconnect Properly.** Do not connect or disconnect probes or test leads while they are connected to a voltage source.

**Ground the Product.** This product is grounded through the grounding conductor of the power cord. To avoid electric shock, the grounding conductor must be connected to earth ground. Before making connections to the input or output terminals of the product, ensure that the product is properly grounded.

**Observe All Terminal Ratings.** To avoid fire or shock hazard, observe all ratings and markings on the product. Consult the product manual for further ratings information before making connections to the product.

**Do Not Operate Without Covers.** Do not operate this product with covers or panels removed.

**Avoid Exposed Circuitry.** Do not touch exposed connections and components when power is present.

**Do Not Operate With Suspected Failures.** If you suspect there is damage to this product, have it inspected by qualified service personnel.

**Do Not Operate in Wet/Damp Conditions.**

**Do Not Operate in an Explosive Atmosphere.**

**Keep Product Surfaces Clean and Dry.**

**Provide Proper Ventilation.** Refer to the manual's installation instructions for details on installing the product so it has proper ventilation.

## Symbols and Terms

**Terms in this Manual.** These terms may appear in this manual:



---

**WARNING.** *Warning statements identify conditions or practices that could result in injury or loss of life.*

---



---

**CAUTION.** *Caution statements identify conditions or practices that could result in damage to this product or other property.*

---

**Terms on the Product.** These terms may appear on the product:

DANGER indicates an injury hazard immediately accessible as you read the marking.

WARNING indicates an injury hazard not immediately accessible as you read the marking.

CAUTION indicates a hazard to property including the product.

**Symbols on the Product.** The following symbols may appear on the product:



Protective Ground  
(Earth) Terminal



CAUTION  
Refer to Manual

# Preface

This is the user manual for the RSA2203A and RSA2208A Real-Time Spectrum Analyzers. It covers the following information:

- Describes the capabilities of the analyzer and how to install it
- Explains how to operate the analyzer: how to control acquisition of, processing of, and input/output of information
- Shows the menu structure and lists accessories of the analyzer

## About This Manual

This manual is composed of the following chapters:

- *Getting Started* describes the product overview, architecture, installation, and calibration of the analyzer.
- *Operating Basics* explains the functions of the front, rear, and side panels and menu items of the analyzer, and describes the basic menu operations. This section also provides tutorials for beginners. It gives step-by-step procedures for measurement using a signal generator.
- *Reference* explains the basic concepts of measurement processes and application-specific operations. It also describes the front panel keys and menus.
- *Appendices* provide additional information including the menu tree, accessories, and cleaning information.

First time users should install the analyzer in *Getting Started*, then go to *Operating Basics* and perform the tutorials beginning on Page 2–29.

The analyzer uses Microsoft Windows XP as the operating system. This manual does not describe common usage of Windows XP. Refer to your Windows manuals as necessary.

## Related Documents

In addition to this user manual, the following documentation is available for your analyzer. Tektronix part numbers are supplied in *Appendix E: Options and Accessories*.

- *RSA2203A and RSA2208A Programmer Manual* (standard accessory) contains an alphabetical listing of the programming commands and other information related to controlling the analyzer over the GPIB interface.
- *RSA2203A and RSA2208A Service Manual* (optional accessory) describes how to verify the characteristics of, adjust, disassemble, assemble, and troubleshoot the analyzer, and contains the information required for repair, including module replacement, and calibration.

## Conventions

This manual uses the following conventions:

- Front-panel key and control labels are printed in the manual in upper case text. For example, SPAN, PEAK, PRINT. If it is part of a procedure, the key or control label is printed in boldface. For example:

Press **SPAN**.

- To identify keys on the front panel, the area name label precedes the key. For example:

Press the MODE: **DEMODO** key.

- Menu and on-screen form titles are printed in the manual in the same case (initial capitals) as they appear on the analyzer screen, such as Span, Source, and Channel Power. If it is part of a procedure, the menu title is shown in boldface. For example:

Press the **Source** side key.

- A series of keys, controls, and/or menu items separated by an arrow symbol (→) indicates the order in which to perform the listed tasks. For example:

Select **RBW/FFT** → **Filter Shape...** → **Gaussian**.



# Getting Started



# Product Overview

The RSA2203A and RSA2208A are portable real-time spectrum analyzers with RF measurement capability up to 3 GHz (RSA2203A) and 8 GHz (RSA2208A). The real-time spectrum analyzer has a vastly different architecture from traditional tools, and is uniquely capable of capturing continuous, intermittent, or random signals with equal ease. The waveform and measurement results of data acquired seamlessly can be displayed in various formats such as frequency versus amplitude, time versus amplitude/frequency/phase, AM/FM/PM demodulation, and spectrogram containing three dimensional information of frequency, time, and amplitude/phase.

## Features

- Measurement frequency range  
10 MHz to 3 GHz for RSA2203A; 10 MHz to 8 GHz for RSA2208A  
DC to 20 MHz (Option 05)
- 100 Hz to 3 GHz measurement span and 10 MHz vector span
- Real-time analysis for seamless capture of time-varying RF signals
- Spectrum analysis of power, ACPR, C/N, OBW, EBW, and spurious
- Analog modulation analysis of AM, PM, FM, ASK and FSK signals
- Time characteristic analysis including pulse measurements
- CCDF analysis
- Time-correlated simultaneous views
  - Spectrum display
  - Spectrogram display (frequency versus time versus power)
  - Time domain display (IS-95 standard)
  - Analog demodulation display:  
time versus modulation factor, phase, or frequency
- 8.4 inch TFT color display and sturdy cabinet

## Application

The RSA2203A and the RSA2208A can perform real-time analysis for the following purposes:

- Signal quality analysis of analog and digital modulation
- Understanding frequency and spectral occupancy behavior over time
- Capture and characterization of undesired, unknown, or interfering signals
- Device/system design or operational diagnostic measurement
- Getting answers to elusive EMI problems
- VCO/synthesizer design
- RFID device characterization
- Spectrum monitoring
- Radar measurements

## Difference between RSA2203A and RSA2208A

The RSA2203A and the RSA2208A have the same functions except for their measurement frequency ranges:

RSA2203A . . . . . DC to 3 GHz  
RSA2208A . . . . . DC to 8 GHz

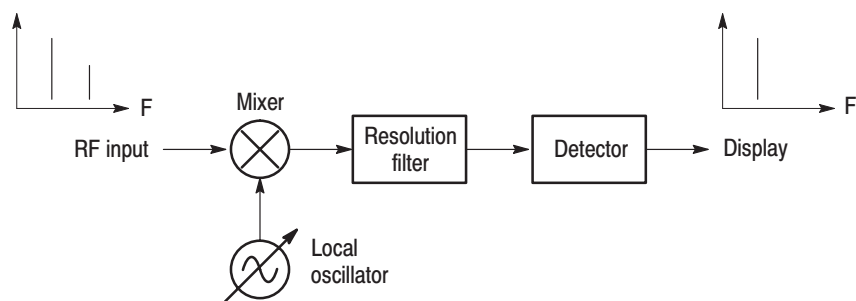
Descriptions in this manual apply to both the RSA2203A and the RSA2208A unless otherwise noted.

## Real-Time Analysis

This section explains real-time analysis with the comparison of conventional swept spectrum analyzer and real-time spectrum analyzer.

### Conventional Swept Spectrum Analyzer

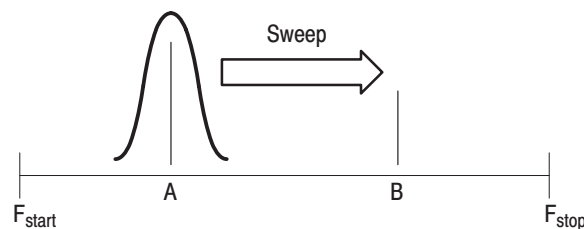
Figure 1–1 is a block diagram of the conventional swept spectrum analyzer. There are two RF input signals in this example. The RF signal is converted to IF (intermediate frequency) by the swept local oscillator. IF output goes through a bandpass filter, where resolution of the spectrum analyzer is defined.



**Figure 1–1: Concept of the swept spectrum analyzer**

The filter is swept from  $F_{\text{start}}$  to  $F_{\text{stop}}$ . See Figure 1–2. Only signals within the filter bandwidth are observed at one point in time. Signal A is detected first and then signal B is detected and displayed.

**NOTE.** An intermittent signal, such as a burst phenomenon, will not be detected unless it is present at the exact moment that the filter is being swept past it.



**Figure 1–2: Sweep of resolution filter**

### Real-Time Spectrum Analyzer

The real-time spectrum analyzer is conceptually equipped with a series of bandpass filters as shown in Figure 1-3. Signals passing through those filters are concurrently observed and recorded continuously. Signals A and B are concurrently acquired and displayed as shown in Figure 1-4.

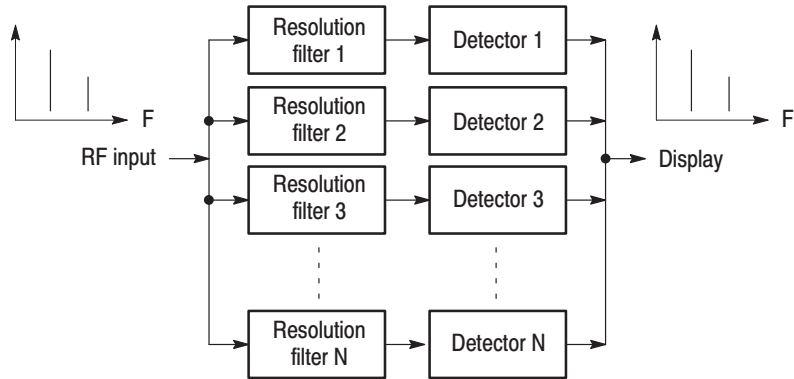


Figure 1-3: Concept of the real-time spectrum analyzer

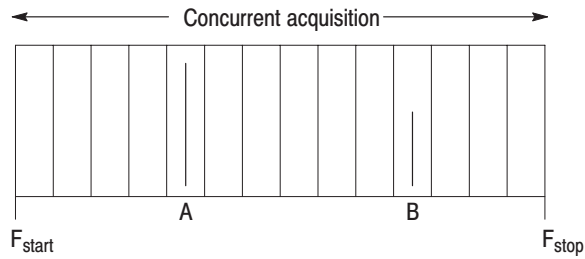
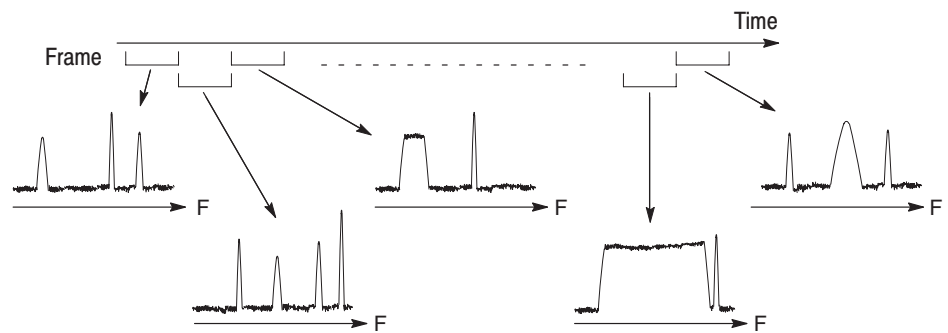


Figure 1-4: Concurrent acquisition

The method actually used to concurrently acquire signals in a certain frequency range is not bandpass filters, but FFT (Fast Fourier Transformation). The RSA2203A or the RSA2208A first acquires a series of frames of data in the time domain, as shown in Figure 1–5, and then performs the FFT process for each frame. This method enables continuous analysis of spectra and ensures the capture of real-time phenomenon such as the W-CDMA burst signal. The RSA2203A and the RSA2208A are equipped with a 51.2 MHz A/D converter to analyze the spectrum by single scanning for spans up to 10 MHz.



**Figure 1–5: Frame acquisition**

## Architecture

Figure 1–6 shows the block diagram of the signal processing system.

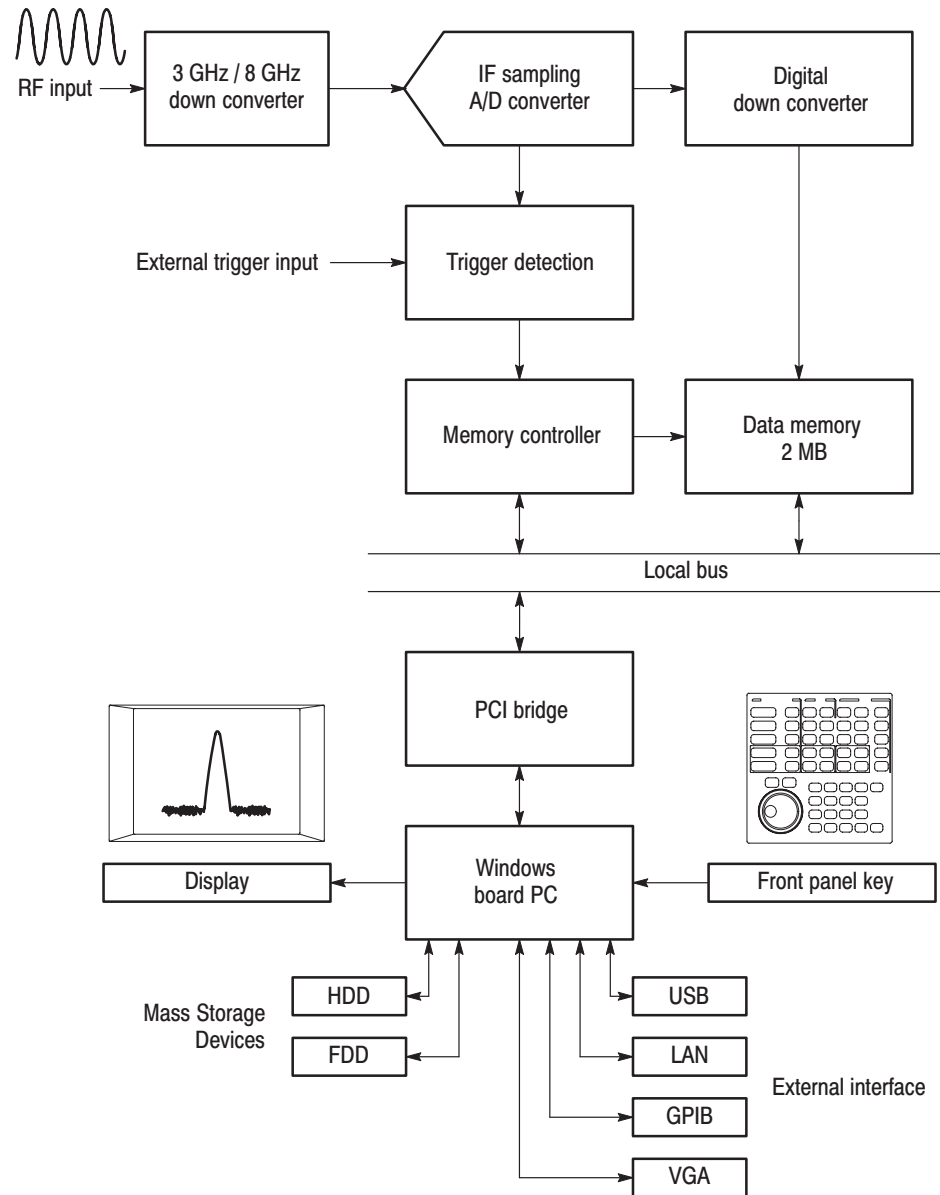


Figure 1–6: Block diagram



**3 GHz / 8 GHz  
Down Converter**

Converts the RF signal, input through the front-panel INPUT connector, into a 20 MHz IF signal. This converter processes signals up to 3 GHz for RSA2203A and 8 GHz for RSA2208A by IF conversions in three stages. A 10 MHz oscillator provides a high-accuracy reference for all stages of IF conversion. The converter also adjusts signals for A/D conversion using a low-noise amplifier, fine-tuning attenuator, and anti-alias filter. The output signal from the down converter is sent to the IF sampling A/D converter described below.

**IF Sampling A/D Converter**

The IF analog output from the down converter enters the A/D converter through the fine-tuning attenuator, low-noise amplifier, and anti-alias filter, to be converted into a digital signal. The sampling rate of the A/D converter is 51.2 MHz with a resolution of 14 bits.

**Digital Down Converter**

The digital down converter splits the real signal from the A/D converter into complex (I and Q) components and limits the frequency span of the resulting signal.

The down converter performs span and center frequency fine-tuning. This converter consists of two primary stages. In the baseband (Option 05), the first stage converts a 0 to 20 MHz real signal into a complex signal of  $\pm 10$  MHz. The second stage converts frequency to set any center frequency.

A decimating filter between stages changes the span by effectively reducing the sampling rate. A 503 tap FIR filter and four stage comb filter allows extremely accurate filtering with minimal spurious emissions.

The data streams from the digital down converter are then divided into frames and saved in data memory.

**Data Memory**

A high-speed 2 MB standard SDRAM stores spectrum data. For each data point, I and Q data use 2 bytes. This memory can store 500 frames for 1 waveform = 1024 points of analysis. The memory is accessed from the system controller through the ISA/PCI bridge.

### **Windows Board PC**

The system controller board has an Intel Pentium III CPU. It runs on Windows XP, and controls menu operation from the front panel keys. It is equipped with a 20 GB hard disk and 3.5 inch disk drive to store data and settings. Waveforms, menus, and measurement results are shown on the color display, which uses an 8.4 inch XGA TFT-LCD module.

The standard analyzer has the following external interfaces:

- USB (for mouse, keyboard, and/or printer)
- LAN (Ethernet 10/100BASE-T)
- GPIB
- VGA (for an external monitor)

# Installation

This section describes how to install this instrument. The topics are organized as follows:

- Unpacking to check contents
- Applying the power
- Setting up the stand
- Functional check
- Powering off the analyzer
- Restart
- Backing up the user file

Before starting installation, you should become familiar with the *General Safety Summary* on page xiii.

## Unpacking to Check Contents

1. This product is packed in a cardboard box for delivery. Before opening the box, make sure that there is no damage on the surface.
2. Open the box, check that the product has no damage and that all the standard accessories are found inside. For a list of accessories, refer to *Standard Accessories* on page E-3. If you find any damaged or missing components, contact your local Tektronix representative.
3. It is recommended to keep the box and packing materials. You may need them to send this product to Tektronix for calibration or repair.



---

**CAUTION.** *The analyzer has exhaust fans on the side panel. Leave a space of at least 5 cm (2 in) on both sides for proper air circulation.*

---

## Applying Power

Power on the analyzer using the following procedure:

### AC Power Requirements

The analyzer operates from an AC line frequency of 47–63 Hz, over the range of 90–250 Volts, without the need for configuration, except the power cord. Refer to page E-2 for the power cord options.

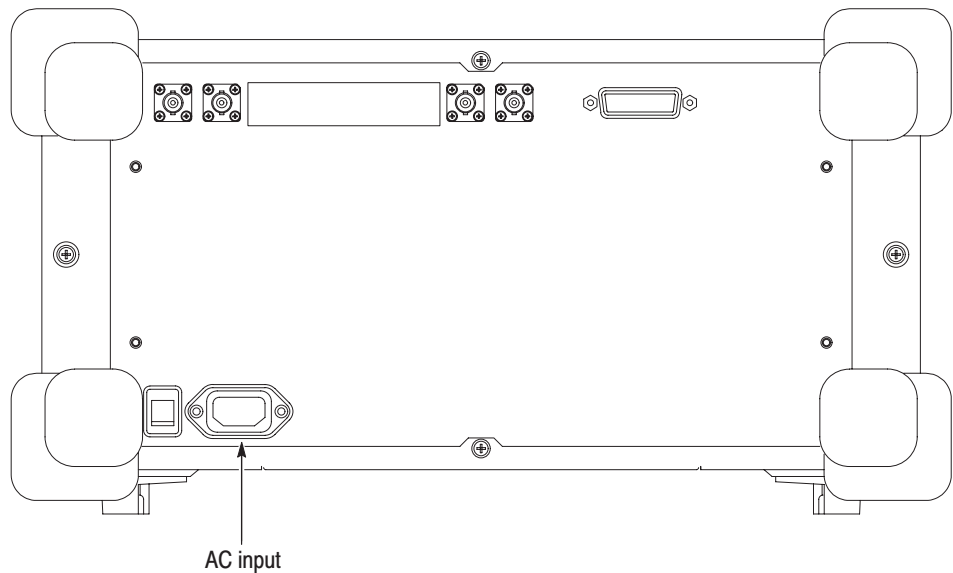
The maximum power consumption is 350 W. Refer to *Appendix A, Specifications*, for additional information on power and environmental requirements.



**CAUTION.** Use only power cords that are approved for the country of use. Using non-approved power cords could result in fire or shock hazard.

### Connecting the Power Cord

1. Plug the power cord into the AC input on the rear panel.

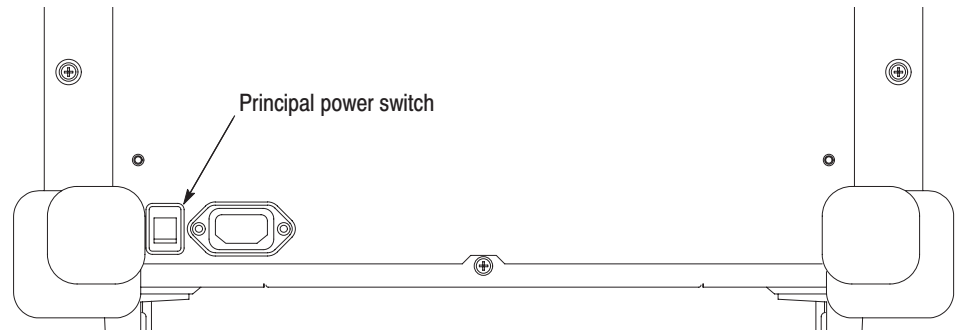


**Figure 1-7: AC Input (rear panel)**

2. Connect the plug of the power cord to a properly grounded outlet.

**Turning on the Analyzer**

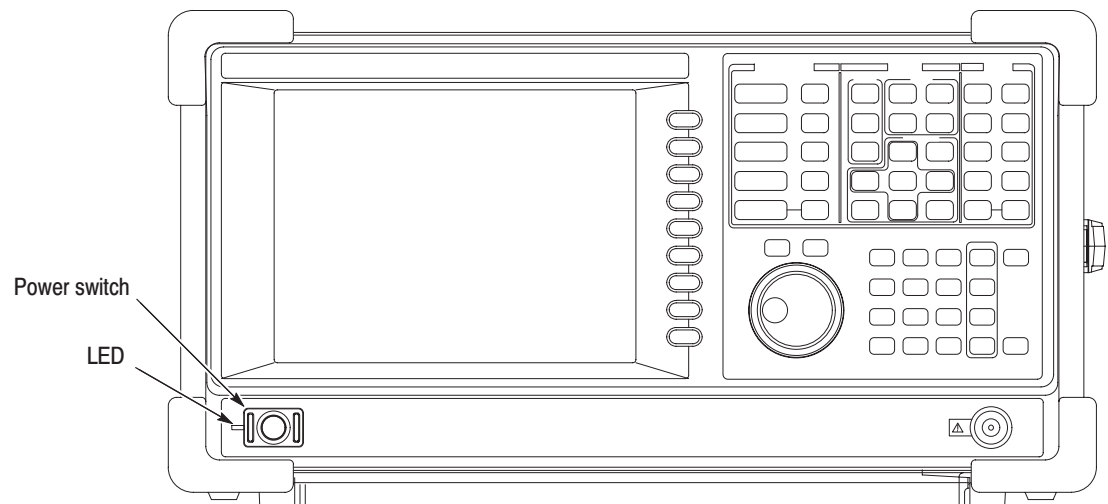
1. Turn on the principal power switch on the rear panel.



**Figure 1-8: Principal power switch (rear panel)**

When you turn on the principal power switch, a voltage is applied to the analyzer standby circuit. Make sure the LED next to the power switch on the front panel lights up in orange.

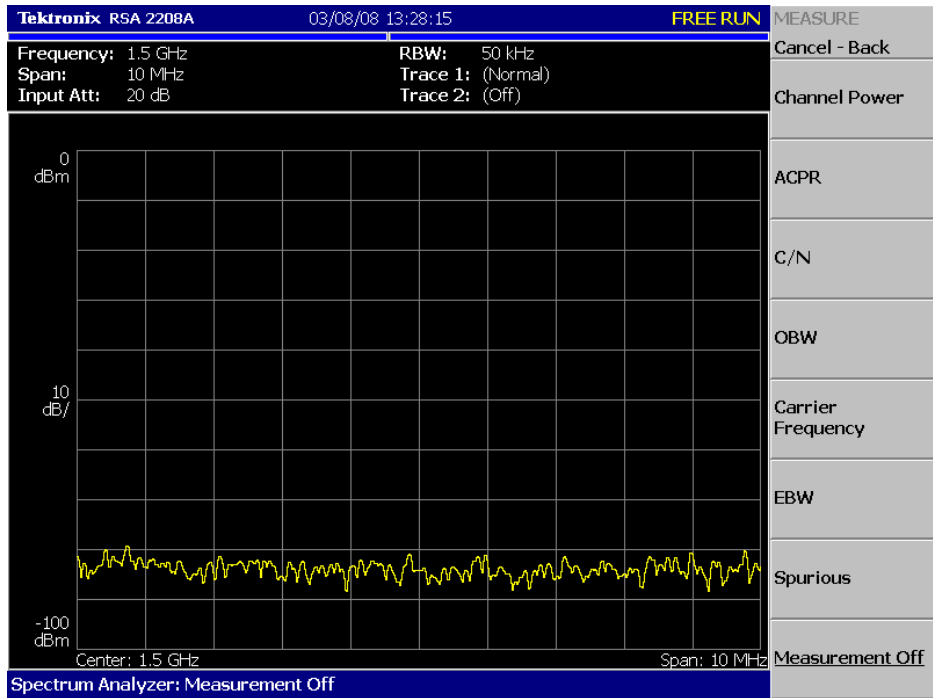
2. Turn on the power switch (**ON/STANDBY**) on the lower left of the front panel. The LED next to the power switch changes to green.



**Figure 1-9: Front panel power switch (ON/STANDBY switch)**

When you turn on the analyzer, Windows XP boots up. After several minutes, the analyzer application starts up.

The initial screen appears as shown in Figure 1-10. The displayed spectrum represents the noise floor of the analyzer.

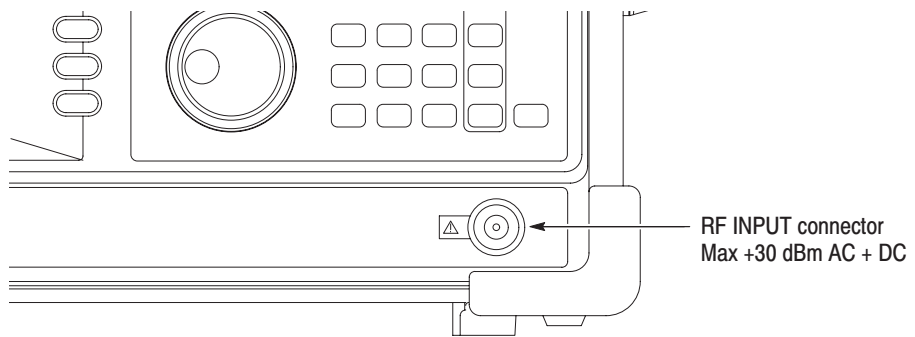


**Figure 1-10: Initial screen**

If “UNCAL” is displayed on top of the screen, run the gain calibration routine (refer to *Calibrating Gain* on page 1-23).



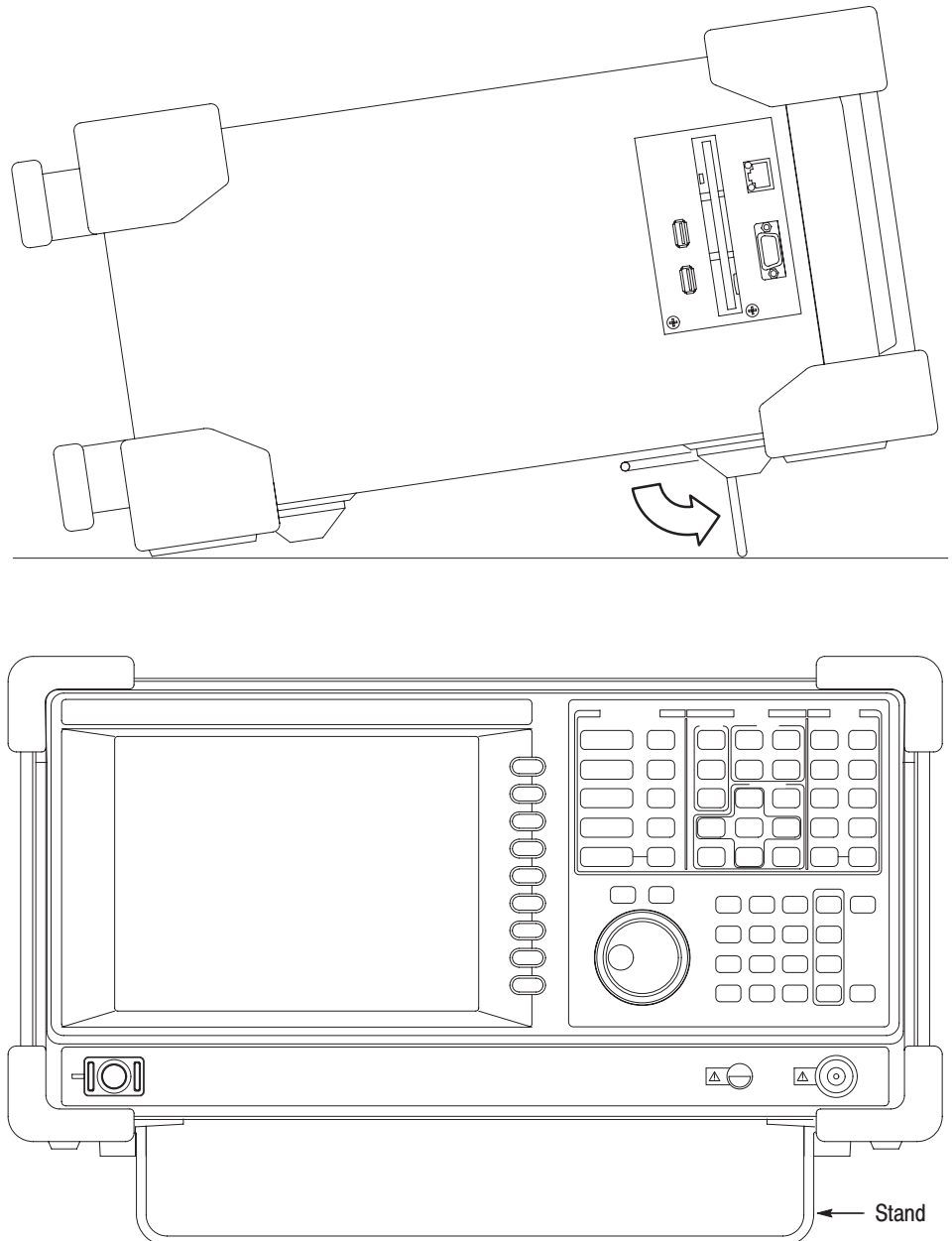
**CAUTION.** Never apply signals with a combined amplitude greater than +30 dBm to the RF INPUT connector. If you exceed this input rating, you can permanently damage the analyzer. (The RF INPUT connector is shown in Figure 1-11.)



**Figure 1-11: RF INPUT connector**

## Setting Up the Stand

To set up the stand, place the analyzer on a table. Lift the front of the analyzer and pull out the stand until it is perpendicular to the analyzer.



**Figure 1-12: Setting up the stand**

## Functional Check

The analyzer has a built-in calibration signal source with frequency of 50 MHz and amplitude of approximately  $-20$  dBm. Using this source, perform this quick functional check to verify that your instrument is operating correctly.

1. Turn on the analyzer.
2. Display the spectrum of the calibration signal:
  - a. Press the **S/A** key on the front panel and then press the **Spectrum Analyzer** side key.
  - b. Press the **PRESET** key on the front panel to reset the analyzer.
  - c. Press the **INPUT** key on the front panel.
  - d. Press the **Signal Input Port...** side key to select **Cal**.

The spectrum of the calibration signal appears.

- e. Check that “INPUT: CAL” and “FREE RUN” are displayed in the status indicator at the upper right of the screen (see Figure 1–13).

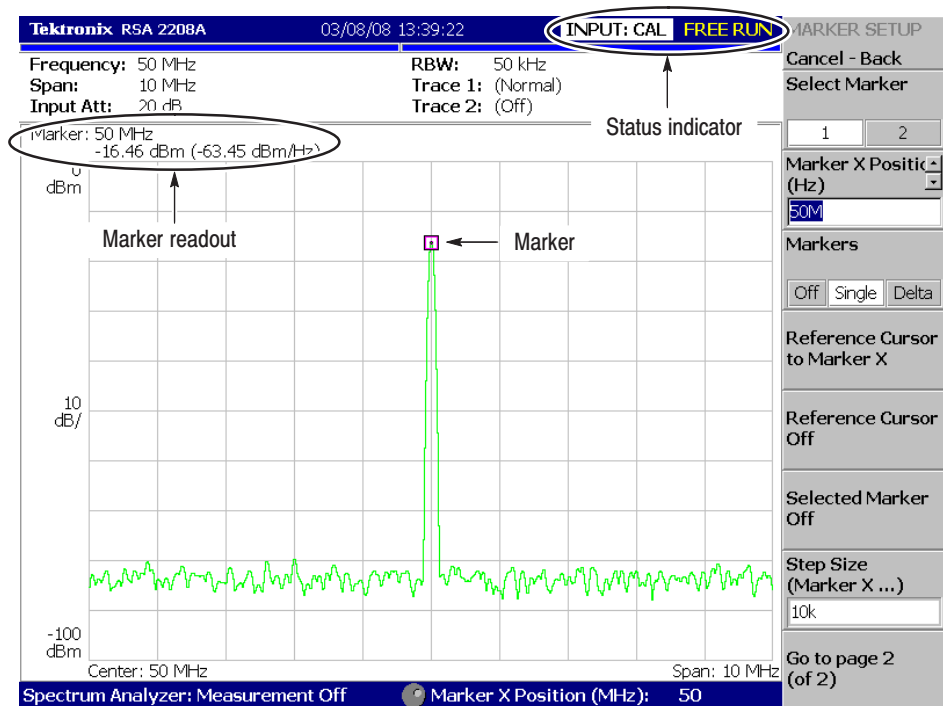
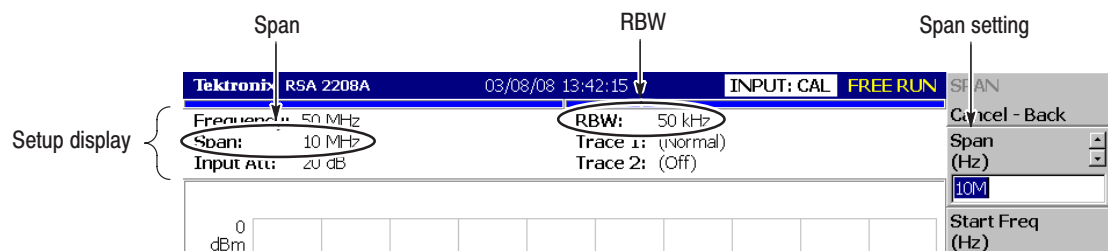


Figure 1–13: Spectrum of the calibration signal (50 MHz, about  $-20$  dBm)



3. Check the center frequency and peak amplitude using the marker:
  - a. Press the **PEAK** key on the front panel to place the marker on the peak (see Figure 1–13).
  - b. Check the marker readouts on screen. The frequency should be 50 MHz and the amplitude should be approximately  $-20$  dBm.
  - c. Press the **MARKER SETUP** key on the front panel and then the **Markers** side key to select Off. Check that the marker disappears.
4. Check the RBW (Resolution Bandwidth) while changing the span setting.
  - a. Press the **SPAN** key on the front panel.
  - b. Confirm that the span is 10 MHz and the RBW is 50 kHz in the setup display on the upper part of the screen (see Figure 1–14).



**Figure 1–14: Setup display**

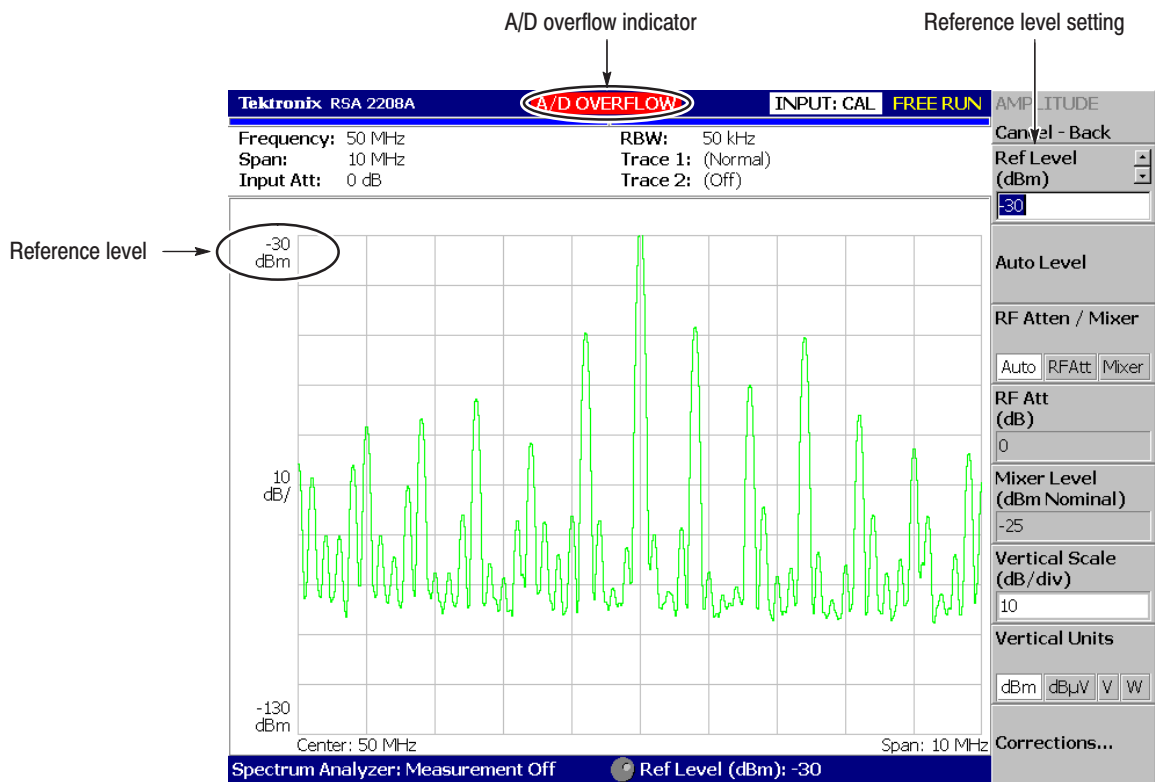
- c. Using the general purpose knob, change the span setting as listed in Table 1–1 and check that the RBW is displayed correctly.

**Table 1–1: Span and RBW**

Span	RBW
10 MHz	50 kHz
5 MHz	20 kHz
100 kHz	500 Hz
1 kHz	20 Hz

- d. Using the numeric keypad, set the span back to 10 MHz. (Press **1** → **0** → **MHz**, in that order, on the keypad.)

5. Check the reference level:
  - a. Press the **AMPLITUDE** key on the front panel.
  - b. Make sure that the reference level is set to 0 dBm with the **Ref Level** side key. Check that 0 dBm is displayed on the upper left side of the graticule (see Figure 1–15).
  - c. Use the general purpose knob to set the reference level to –30 dBm.
  - d. Confirm that A/D OVERFLOW is indicated in the red box at the top center of the screen. Make sure that –30 dBm is displayed on the upper left side of the graticule and that the spectrum waveform is distorted as shown in Figure 1–15.



**Figure 1–15: Reference level setting and A/D overflow indicator**

- e. Using the numeric keypad, set the reference level back to 0 dBm. (Press **0** → **ENTER**, in that order, on the keypad.)

6. Check the spectrogram display:
  - a. Press the **S/A** key on the front panel.
  - b. Press the **S/A with Spectrogram** side key. Check that the spectrogram is displayed on the lower side of the screen (see Figure 1–16).
  - c. Press the **RUN/STOP** key on the front panel to stop data acquisition. Confirm that the trace display freezes and **PAUSE** is displayed in the status indicator at the top right of the screen.

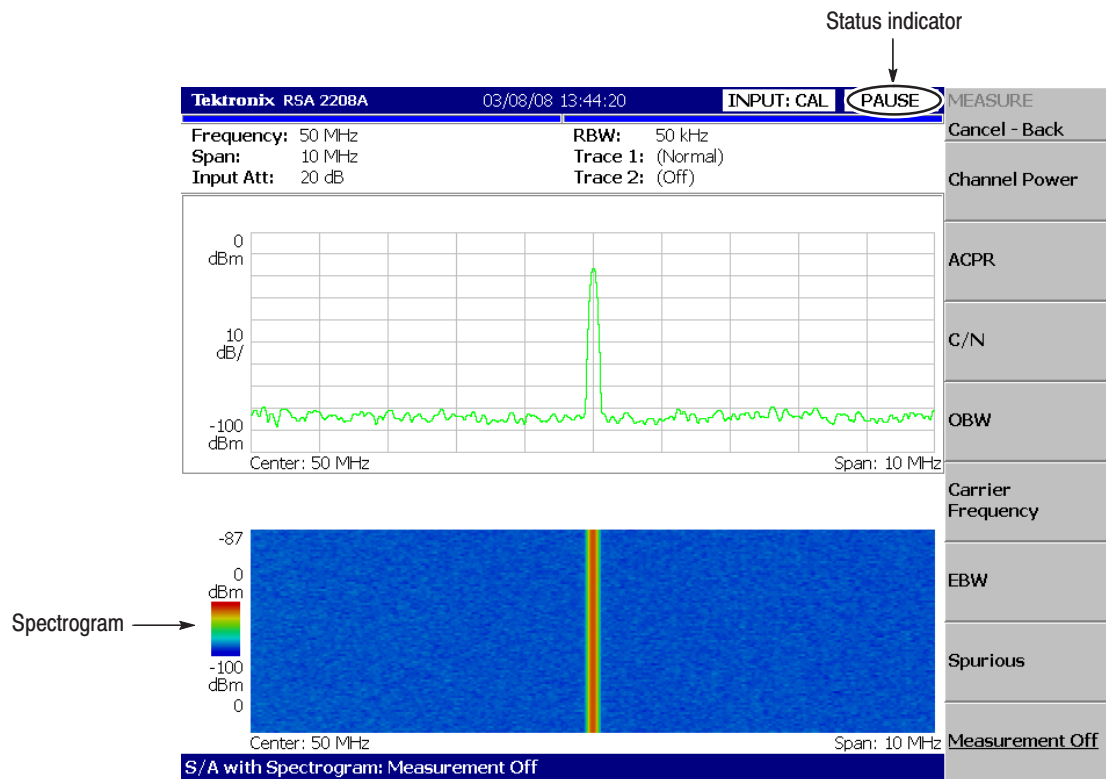


Figure 1–16: Spectrogram display

## Powering Off the Analyzer

Turn off the power switch on the front panel.



---

**CAUTION.** *When you power on or off the analyzer, you must use the front-panel power switch. Failure to do so may cause the operating system to shut down improperly.*

*When you power on the analyzer again, wait at least 10 seconds after the last power off.*

---

When you press the front-panel ON/STANDBY switch, the analyzer starts a shutdown process (including a Windows shutdown) to preserve settings and then power off. The LED next to the power switch changes to orange. Avoid using the rear-panel power switch or disconnecting the power cord to power off the analyzer.

To completely remove power to the analyzer, perform the shutdown just described, and then set the power switch on the rear panel to off.

---

**NOTE.** *Turning off the front-panel power switch does not shut down the principal power supply completely. To turn off the principal power supply, press the principal power switch on the rear panel. Turning off the principal power switch turns off the front-panel LED. When you do not use the analyzer for a long time or in case of emergency, you should unplug the power cord.*

---

## Restart

When the analyzer operates abnormally, use the following procedure to turn the analyzer off and on again.

---

**NOTE.** *When the analyzer operates abnormally, it will not be shut down by turning off the front-panel power switch alone.*

---

1. Make sure that the front-panel power switch is in the turned-off position.
2. Turn off the principal power switch on the rear panel.
3. Wait at least 10 seconds and then turn on the principal power switch again.
4. Turn on the front-panel power switch.

## When Scan Disk Appears

If the analyzer was not shut down properly, Windows Scan Disk may run when you turn on the analyzer. When the Scan Disk screen appears, wait until the Scan Disk is completed. If an error is detected, refer to the Windows manual for treatment. For more information on accessing Windows on the analyzer, refer to *Using Windows XP* on page 2–26.

## When the Display Brightness Is Not Even

It is a characteristic of the LCD (Liquid Crystal Display) panel to sometimes have uneven brightness, dead pixels (dots that never turn on) or stuck pixels (dots that always stay on). This is neither a malfunction nor a defect, and not a cause for repair or exchange.

## Backing Up User Files

You should back up your user files on a regular basis as an insurance against system failures. The Back Up tool is located in the System Tool folder in the Accessory folder of Windows. Start this tool to select the files and folders to back up. For more information, use Windows online help. For more information about access to Windows on the analyzer, refer to *Using Windows XP* on page 2–26.

The following files should be backed up more frequently:

- Status files (\*.sta)
- Data files (\*.iqt)
- Trace files (\*.trc)
- Correction files (\*.cor)

Refer to page 3–157 for details on file operations.

### Using LAN

The analyzer is equipped with LAN Ethernet interface as standard, allowing you to save data in peripheral devices such as other PCs, hard disks, and MO via network. Refer to page 2–5 for details on connecting to LAN.

## About Installation of Other Applications

The analyzer incorporates Windows XP as the operating system. Some combinations of internal measurement applications and external applications may cause deterioration in the basic performance or conflicts between these applications.

It is not recommended that you install other applications, including Microsoft Word, Excel, and Outlook, on the analyzer. If you install an external application, you do so at your own risk, keeping in mind that it may lower the performance of the analyzer.

# Calibration

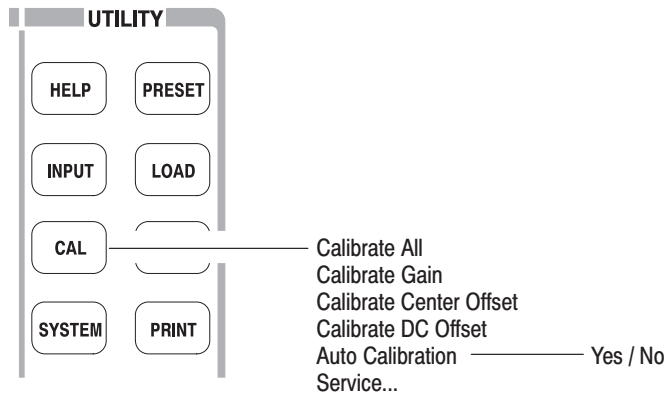
Perform these routines to optimize the analyzer performance:

- Gain calibration
- Center offset calibration
- DC offset calibration (Option 05 only)
- Display brightness adjustment

Each item is explained in this section.

## Cal Menu

Use the **CAL** key to calibrate the analyzer.



**Figure 1-17: Calibration menu structure**

The Cal menu contains the following controls:

**Calibrate All.** Performs all possible calibration operations.

**Calibrate Gain.** Calibrates the internal gain steps.  
Refer to page 1-23 for the gain calibration.

**Calibrate Center Offset.** This calibration cancels a center offset.  
Refer to page 1-24 for the center offset calibration.

**Calibrate DC Offset.** *Option 05 only.* This calibration cancels DC offset in baseband. Refer to page 1-25 for the DC offset calibration.

**Auto Calibration.** Determines whether to automatically perform all possible calibration operations. The default setting is On.

**Service...** This menu item is only to be used by qualified personnel for repair and calibration. Refer to the *RSA2203A Service Manual* (optional accessory) for details.

If you want to perform all possible calibration operations together, press the **Calibrate All** side key. When **Auto Calibration** is set to Yes, they will be performed automatically any time the analyzer is in an uncal state.

---

**NOTE.** *When you run the calibration during signal acquisition, the calibration starts after the acquisition is completed.*

---

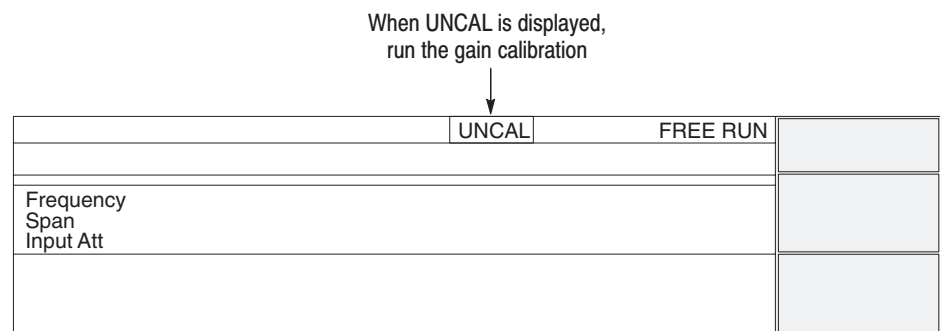


## Calibrating Gain

The gain calibration calibrates the analyzer’s amplifier gain using the internal signal generator. Run this internal calibration routine as required when you boot the analyzer or when UNCAL (uncalibrated) is displayed during operation.

Allow the analyzer to warm up for 20 minutes before you begin the calibration. The warm-up period allows electrical performance of the analyzer to stabilize.

During normal operation, when the ambient temperature changes by more than  $\pm 5$  °C from the temperature at the last calibration, UNCAL is displayed in the yellow box at the top of the screen (see Figure 1–18). If this happens, run the gain calibration.



**Figure 1–18: UNCAL display**

To run the gain calibration, do the following:

1. Press the **CAL** key on the front panel.
2. Press the **Calibrate Gain** side key.

The calibration runs. It takes several seconds to complete the process.

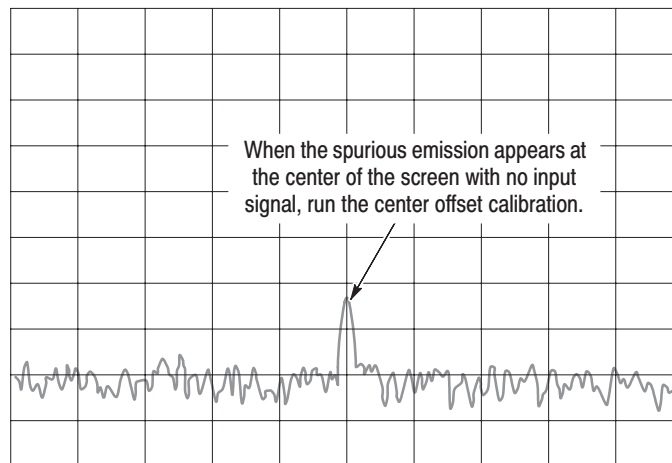
## Calibrating Center Offset

When you display a spectrum and no input signal is present, a spurious emission at the center frequency may appear regardless of frequency settings. The center offset calibration cancels those spurious emissions. If the spurious emission is too obvious when you narrow the span, run the calibration.

---

**NOTE.** *Option 03 only. When you input I and Q signals from the rear panel connectors, set the IQ input signal level to zero externally.*

---



**Figure 1-19: Center offset**

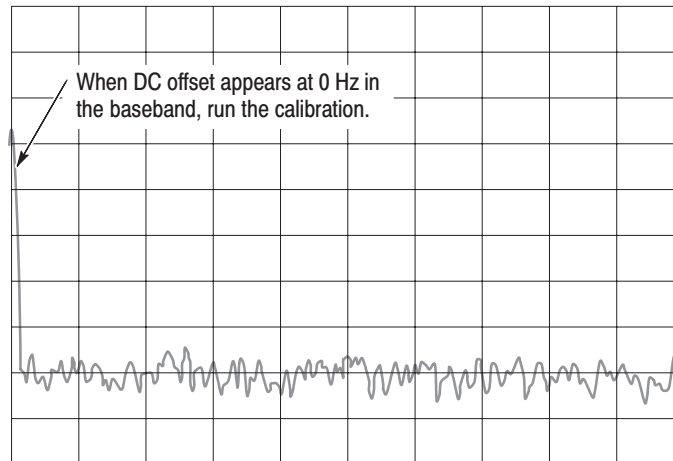
To run the center offset calibration, do the following:

1. Press the **CAL** key on the front panel.
2. Press the **Calibrate Center Offset** side key.

The calibration runs. It takes several seconds to complete the process.

## Calibrating DC Offset (Option 05 Only)

The DC offset calibration cancels DC offset that appears at 0 Hz in the baseband (DC to 20 MHz). When you change the amplitude setting and the DC offset is too obvious, run the DC offset calibration.



**Figure 1-20: DC offset**

To run the DC offset calibration, do the following:

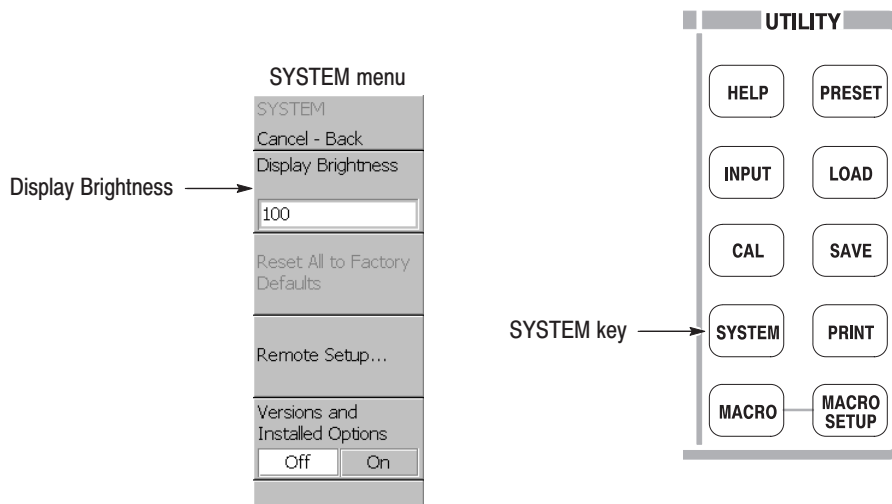
1. Press the **CAL** key on the front panel.
2. Press the **Calibrate DC Offset** side key.

The calibration runs. It takes several seconds to complete the process.

## Adjusting Display Brightness

Adjust the brightness of the display according to your environment.

1. Press the **SYSTEM** key on the front panel (see Figure 1–21).



**Figure 1–21: System menu**

2. Press the **Display Brightness** side key.
3. Turn the general purpose knob to adjust the brightness. The setting range is 0 to 100.

## Confirming Performance

The electrical characteristics described in *Appendix A: Specifications* can be checked only by our service personnel. If you need any service, contact your local Tektronix representative.

# Operating Basics



# Interface Maps

This section describes the controls, connectors, and display:

- Controls and connectors
  - Front panel
  - Rear panel
  - Side panel
  - Using a mouse and keyboard
- Display screen
  - Elements of the display
  - Status display
  - Front panel key lock
  - Setup display

For the analyzer specifications, refer to *Appendix A: Specifications*.

## Controls and Connectors

Figures 2-1 through 2-3 on the following pages show the controls and connectors on the front, the side, and the rear panels.

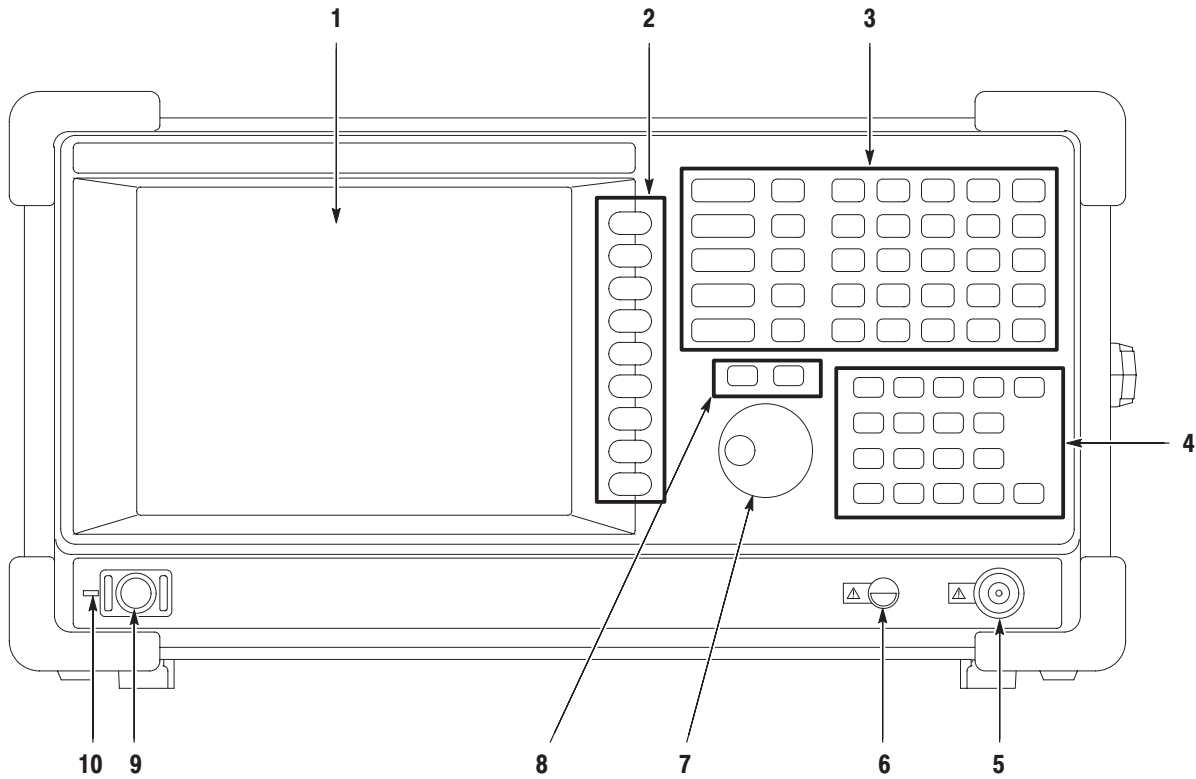


Figure 2-1: Front panel



**Front-Panel Interface**

1. **Display.** LCD (Liquid Crystal Display).  
Size: 21.3 cm (8.4 inch)  
Resolution: 800 × 600 dots  
Color: 256 colors maximum
2. **Side Keys.** Select menu items associated with menu keys.
3. **Menu keys.** Select menus. Refer to page 2–13 for details.  
Refer to page 2–16 for menu operations.
4. **Keypad.** Enters alphanumeric characters. Refer to page 2–17 for entering a numeric value and page 3–166 for entering a file name.
5. **RF input connector.** Connects an input signal.  
Type: N-type connector  
Input impedance: 50 Ω  
Maximum capacity of non-breakdown input: 30 dBm

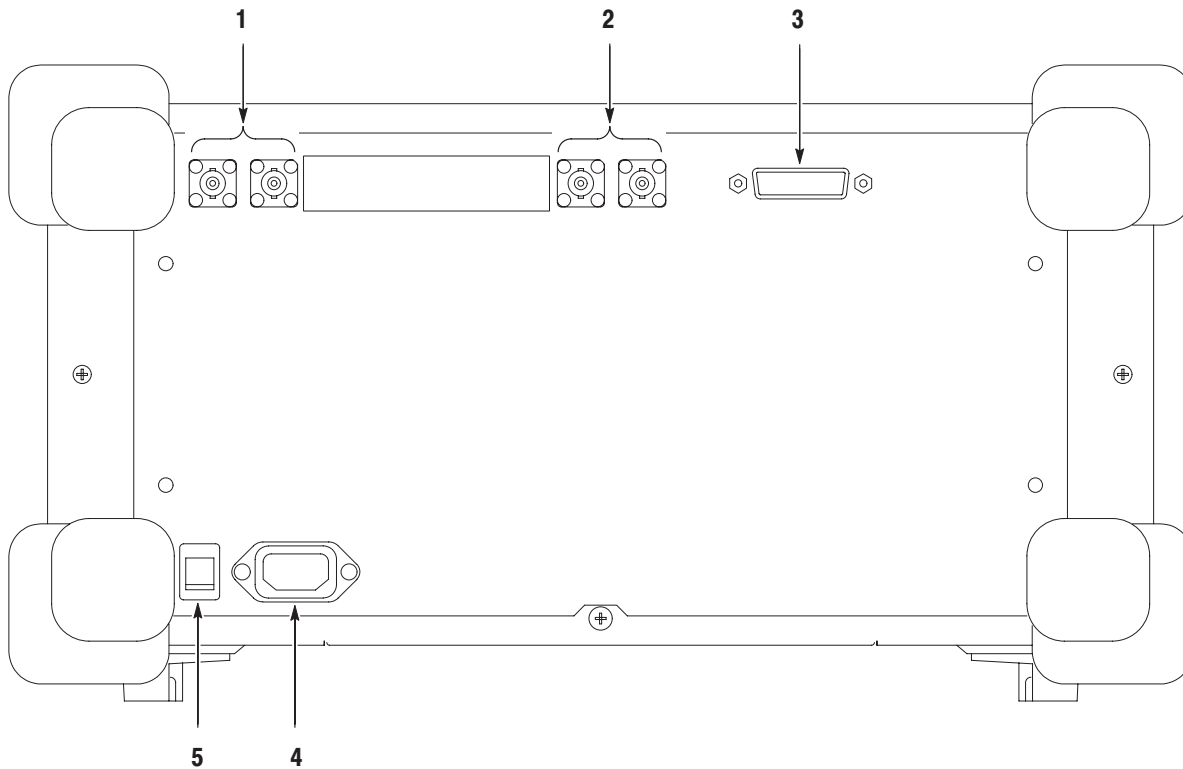


---

**CAUTION.** Do not apply a signal of more than +30dBm; to do so may damage the instrument.

---

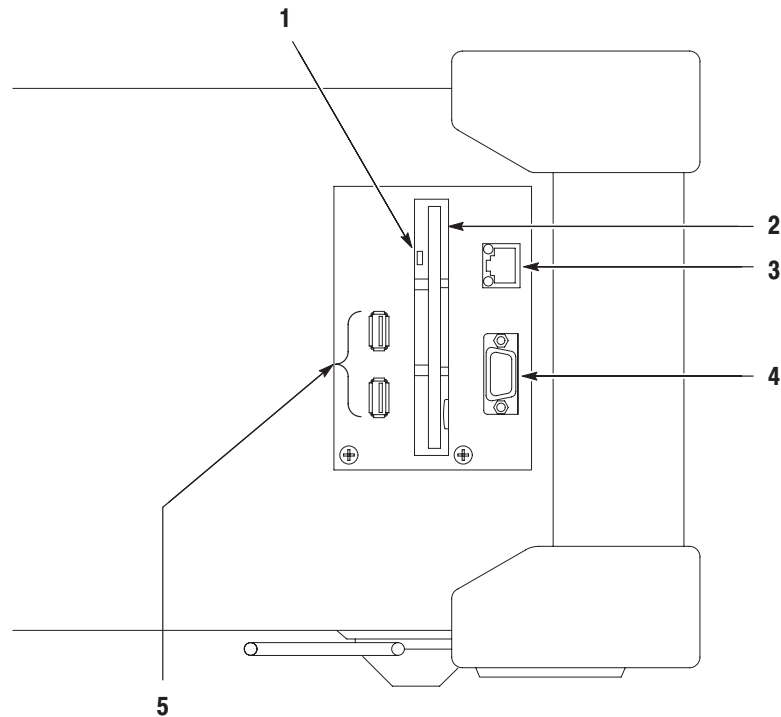
6. **Preamplifier power source.** Provides power source for a preamplifier (optional accessory). Refer to Table A–19 on page A–12 for specifications.
7. **General purpose knob.** Changes a setting.
8. **Up/Down keys.** Increases or decreases a value.  
Refer to page 2–18 for changing a setting using the general purpose knob or the up/down keys.
9. **Power switch (ON/STANDBY).** Refer to page 1–10 for applying power.
10. **LED.** Green on operating, orange on standby.



**Figure 2-2: Rear panel**

**Rear-Panel Interface**

1. **REF IN/OUT connector.** 50  $\Omega$  BNC connector for reference signal input/output. Refer to page A-12 for specifications.
2. **TRIG IN/OUT connector.** 50  $\Omega$  BNC connector for trigger signal input/output. Refer to page A-10 for specifications.
3. **GPIB connector.** Used to control the analyzer from an external controller. Refer to the *RSA2203A and RSA2208A Programmer Manual* for GPIB control.
4. **AC input.** Connect AC power cable.
5. **PRINCIPAL POWER SWITCH.** When this switch is on, the internal standby circuit is energized. Refer to page 1-10 for a power on procedure.



**Figure 2-3: Side panel**

### Side-Panel Interface

1. **Indicator.** Indicates whether the disk drive is active or not.



**CAUTION.** When this indicator is lit, you must not remove the disk from the disk drive. If you do so, the data stored on the medium may be destroyed or an error may occur.

2. **Floppy disk drive.** A 3.5-inch 2HD (1.44MB) or 2DD (720KB) disk formatted for MS-DOS can be used to save and load data and settings.
3. **LAN Ethernet connector.** 10/100BASE-T connector. When you reboot the analyzer after connecting to LAN, the analyzer recognizes the network speed automatically and sets it to 10 Mbps or 100 Mbps. You can share resources such as files or disks on the network.

**NOTE.** The Windows XP default network settings are done when the instrument is shipped from the factory. Contact your system administrator for information about setting network parameters in your LAN.

For using Windows XP on the analyzer, refer to page 2-26.

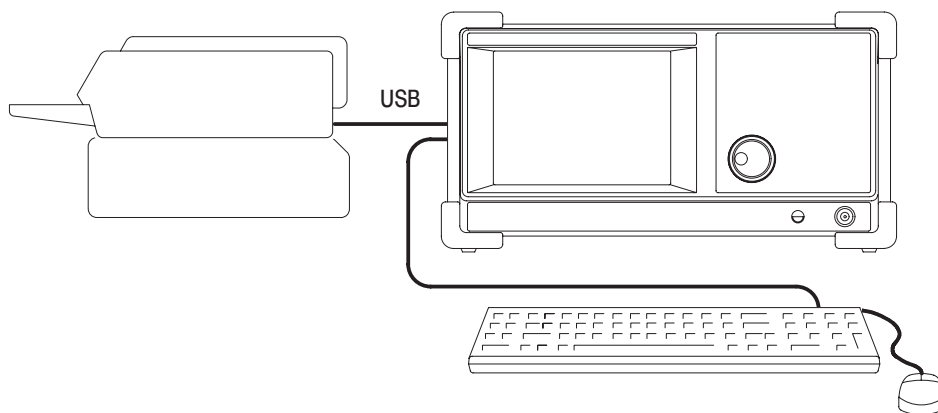
- 4. VGA output connector.** 15 pin D-sub connector (female) to send the display of this instrument to another monitor.

---

**NOTE.** When you use an external monitor, connect a VGA cable to the analyzer and to the monitor, then turn on the monitor before you turn on the analyzer.

---

- 5. USB connectors (two ports).** Connect USB devices such as a mouse, keyboard, and printer. You can connect the devices any time, with no setup (plug & play), to either or both ports. You can also connect a mouse to a USB port on a keyboard (see Figure 2-4).



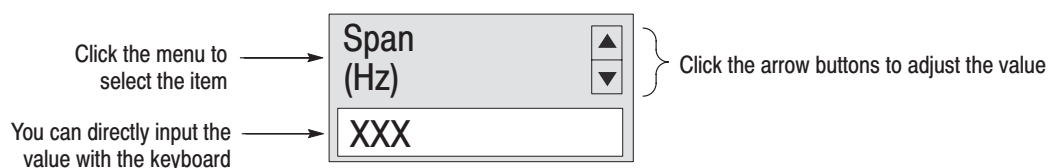
**Figure 2-4: Connecting USB devices**

## Using a Mouse and Keyboard

You can operate the analyzer using the standard accessory mouse and keyboard instead of the side keys and the front panel keypad.

The mouse and keyboard operations are as follows:

- Click the menu item instead of pressing the side keys.
- If the menu item has arrow buttons, click them to select the value.



**Figure 2-5: Operation with mouse and keyboard**

**Table 2-1: Key functions of the keyboard**

Key	Purpose	Function
Numeric keys	Numeric input	Enter a numeric value in a numeric input field.
Left/Right arrow keys	Caret move	Moves the caret in an alpha or numeric input field.
Home	Caret move	Moves the caret to the beginning of an input field.
End	Caret move	Moves the caret to the end of an input field.
Backspace	Alphanumeric input	Deletes the character before the caret.
Delete	Alphanumeric input	Deletes the character after the caret.
ESC	Alphanumeric input	Aborts a numeric entry and restores the original value.
ENTER	Alphanumeric input	Accepts a value in the input field.
K or k key	Alphanumeric input	Kilo ( $10^3$ ). Press ENTER to complete entry of the value.
M key	Alphanumeric input	Mega ( $10^6$ ). Press ENTER to complete entry of the value.
G or g key	Alphanumeric input	Giga ( $10^9$ ). Press ENTER to complete entry of the value.
m key	Alphanumeric input	milli ( $10^{-3}$ ). Press ENTER to complete entry of the value.
U or u key	Alphanumeric input	micro ( $10^{-6}$ ). Press ENTER to complete entry of the value.
N or n key	Alphanumeric input	nano ( $10^{-9}$ ). Press ENTER to complete entry of the value.

## Display Screen

Figure 2–6 shows the elements of the display screen.

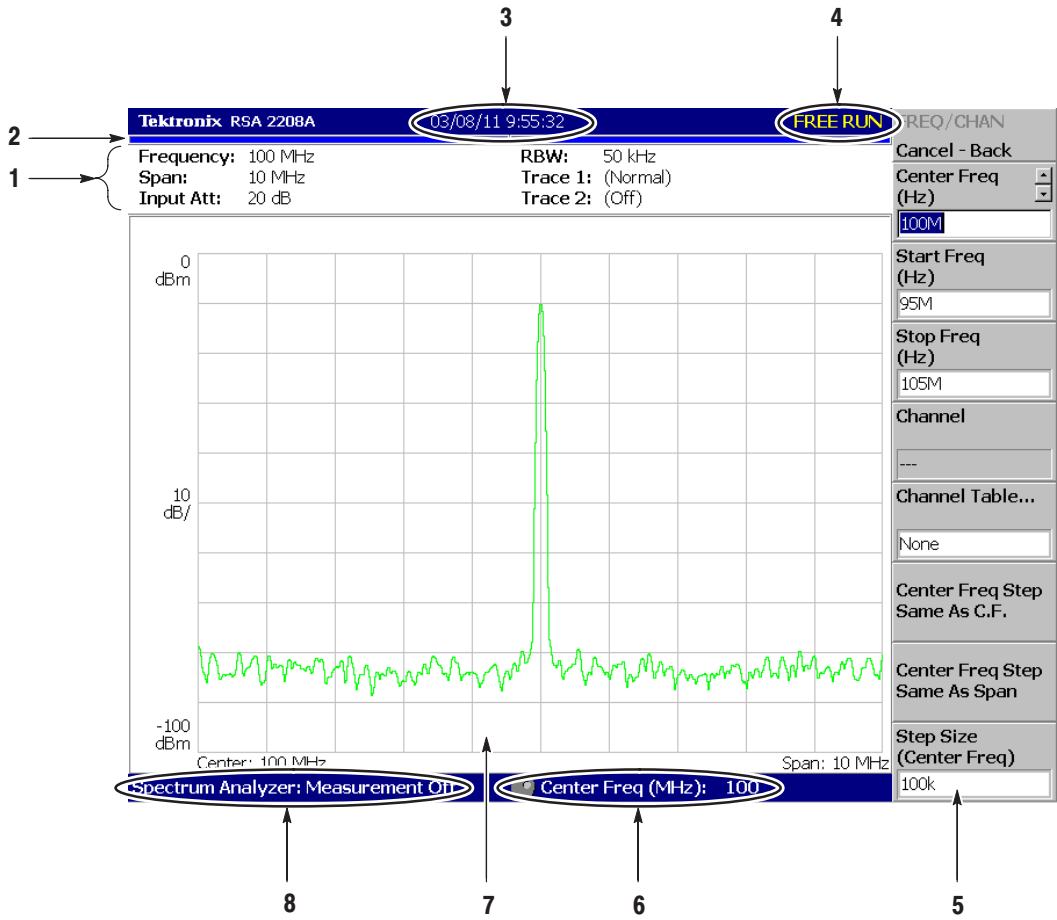


Figure 2–6: Display screen configuration

**Elements of the Display**

1. **Setup display area.** Displays the current hardware value. Refer to *Setup Display* on page 2–12.
2. **Progress bar.** Indicates the progress of the acquisition cycle on the left bar and the measurement cycle on the right bar. The progress fills up in blue from left to right.
3. **Date/Time display area.** Shows the current date and time.
4. **Status display area.** Shows the trigger status. Refer to *Status Display* on page 2–10.
5. **Side menu display area.** When you press a menu key on the front panel, the menu associated with that key is displayed. Refer to page 2–13 for details of menu items.
6. **Menu setting display area.** Displays the last setting of the menu item that can be set with the general purpose knob.
7. **View.** The View window displays the waveform or the measurement results. Multiple views can be displayed on one display screen, depending on the measurement mode.

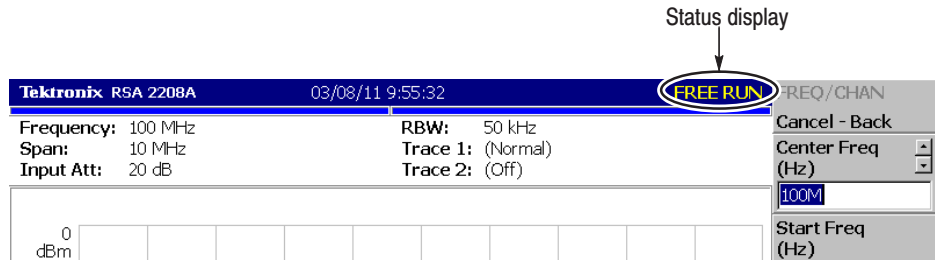
For more information, refer to:

Spectrum analysis (S/A mode)	page 3–1
Modulation analysis (DEMOD mode)	page 3–27
Time analysis (TIME mode)	page 3–43
Setting Views	page 3–123

8. **Measurement function display area.** Displays the measurement function currently in use (the settings of the Mode and Measure menus).

**Status Display**

The status display area in the upper right side of the screen (see Figure 2–7) shows the instrument status as listed in Table 2–2.

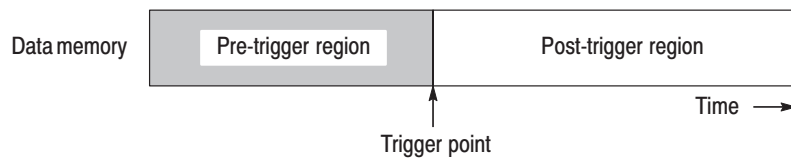


**Figure 2-7: Status display**

**Table 2-2: Status display**

Item	Description
ARM	The pre-trigger portion of the acquisition record is filling. A trigger event occurring during this state will not be recognized.
READY	Pre-trigger data has been acquired, and the instrument is waiting for a trigger event.
TRIG'D	Pre-trigger data has been acquired, and a trigger event has been detected. The instrument is now acquiring post-trigger data.
FREE RUN	The instrument acquires and measures without waiting for a trigger event.
PAUSE	The user has temporarily stopped acquisition/measurement cycling.

The acquired data is stored in the data memory from address zero in order of acquisition. When you set a trigger condition, the acquired data is stored in the pre-trigger region until the trigger event occurs. Thereafter, it is stored in the post-trigger region (see Figure 2–8).

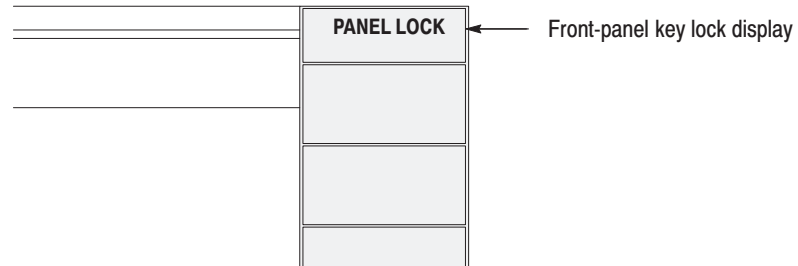


**Figure 2-8: Pre- and post-trigger regions**



### Front Panel Key Lock

When controlling this instrument through GPIB, you can disable all the keys on the front panel except the power switch using the `:SYSTEM:KLOCK` command. At this time, the message “PANEL LOCK” is displayed on the top side key (see Figure 2–9).



**Figure 2–9: Key lock display**

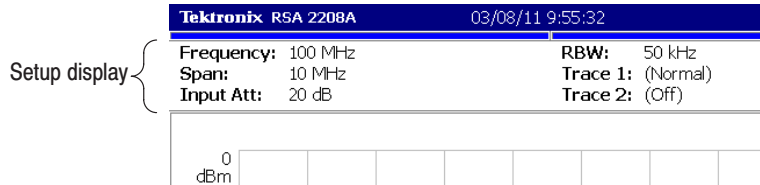
To cancel the key lock, the following two methods can be used:

- Use the `:SYSTEM:KLOCK` command to cancel.
- Turn off the power and then on.

Refer to the *RSA2203A and RSA2208A Programmer Manual* for information about the GPIB commands.

**Setup Display**

The setup display area in the upper part of the screen shows the analyzer hardware settings (see Figure 2–10). The contents differ depending on the measurement mode: spectrum analysis (S/A), modulation analysis (Demod), or time analysis (Time), as shown in Table 2–3.



**Figure 2-10: Setup display**

**Table 2-3: Setup display**

Item	Description	Mode
Frequency	Indicates the center frequency.	All
Span	Indicates the span.	
Input Att.	Indicates the attenuation of an input signal before it enters the internal mixer.	
RBW	Indicates RBW (Resolution Bandwidth) for compatibility with swept spectrum analyzers. Refer to <i>FFT and RBW</i> on page 3–103.	S/A
NBW	Indicates NBW (Noise Bandwidth) instead of RBW when FFT-processed data does not go through RBW process.	
Trace 1 and 2	Indicates the Trace 1 and 2 trace type.	
Spectrum Length	Indicates time length of a 1024-point FFT frame. It is determined by the span.	Real Time S/A
Spectrum Interval	Indicates time interval between FFT frames. Refer to <i>FFT Start Point</i> on page 3–106.	
Acquisition Length	Indicates time to acquire a block of data. It can be set in the Timing menu.	Demod and Time

# Functional Overview

This section provides the operating fundamentals:

- Menu Keys
- Menu Operations
- Measurement Basics
- Setting System Parameters
- Using Windows XP

## Menu Keys

Menu keys on the front panel (shown in Figure 2–11 on page 2–14) are divided into the following three functional groups:

- **MEASUREMENT**  
Sets frequency, amplitude, and time parameters for specified measurement and controls data acquisition.
- **DISPLAY**  
The Display group is divided into the following three subgroups:
  - **MODE.** Selects a measurement mode.
  - **VIEW.** Selects a view content and scales a measurement graph.
  - **MARKERS.** Controls markers.
- **UTILITY**  
Provides system initialization, waveform storage facilities, instrument calibration, screen hard copy, and miscellaneous other functions.

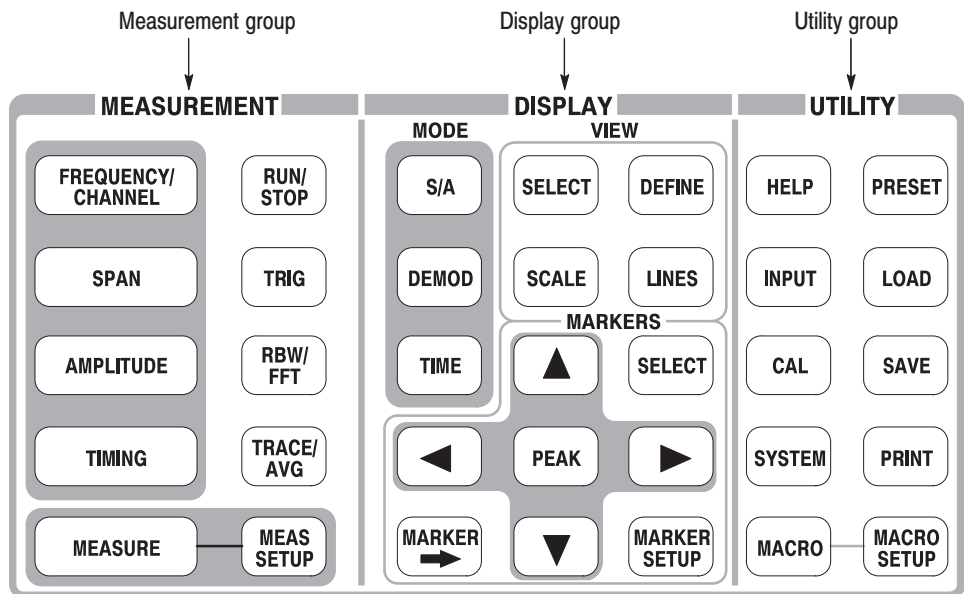




Figure 2-11: Menu keys

Table 2-4 summarizes the front-panel menu key functions. For details, refer to each section listed in the Reference column.

Table 2-4: Menu key summary

Menu group	Menu key	Function	Reference
MEASUREMENT	FREQUENCY /CHANNEL	Sets frequency or channel.	<i>Setting Frequency and Span</i> (page 3-63)
	SPAN	Sets span.	
	AMPLITUDE	Sets amplitude.	<i>Setting Amplitude</i> (page 3-71)
	TIMING	Sets timing parameters.	<i>Setting Timing Parameters</i> (page 3-85)
	RUN/STOP	Start or stop data acquisition.	<i>Starting/Stopping Data Acquisition</i> (page 2-22)
	TRIG	Controls trigger.	<i>Trigger</i> (page 3-91)
	RBW/FFT	Sets RBW and FFT parameters.	<i>FFT and RBW</i> (page 3-103)
	TRACE/AVG	Controls trace display and average function.	<i>Trace Comparison Display and Average Function</i> (page 3-113)

Table 2-4: Menu key summary (Cont.)

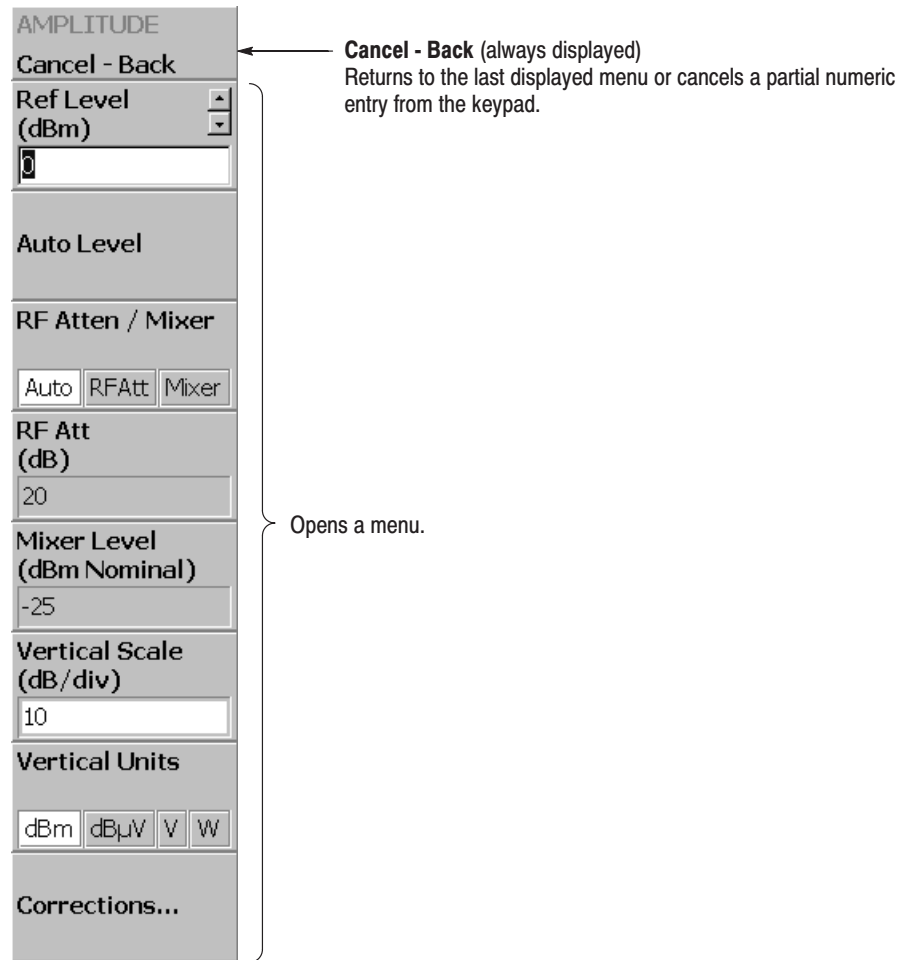
Menu group	Menu key	Function	Reference
MEASUREMENT	MEASURE	Selects a measurement item.	<i>Spectrum Analysis (S/A Mode)</i> (page 3-1)
	MEAS SETUP	Sets measurement parameters.	
DISPLAY: MODE	S/A	Selects spectrum analysis.	<i>Modulation Analysis (Demod Mode)</i> (page 3-27) <i>Time Analysis (Time Mode)</i> (page 3-43)
	DEMODO	Selects modulation analysis.	
	TIME	Selects time analysis.	
DISPLAY: VIEW	SELECT	Selects a view on screen.	<i>Setting View</i> (page 3-123)
	DEFINE	Sets view format.	
	SCALE	Scales a graph.	
	LINES	Controls display lines.	<i>Display Line</i> (page 3-131)
DISPLAY: MARKERS	PEAK	Searches for peak on waveform.	<i>Marker Operation and Peak Search</i> (page 3-139)
		Move the marker to the next peak.	
	SELECT	Selects a marker.	
	MARKER 	Sets parameters based on the marker position.	
	MARKER SETUP	Sets marker parameters.	
UTILITY	HELP	Displays online help.	<i>Using Online Help</i> (page 3-151)
	INPUT	Selects the input source.	<i>Selecting Input Source</i> (page 3-155)
	CAL	Calibrates the analyzer.	<i>Calibration</i> (page 1-21)
	SYSTEM	Controls system parameters.	<i>Setting System Parameters</i> (page 2-23)
	PRESET	Returns settings to the factory defaults.	<i>Restoring Default Settings</i> (page 2-22)
	LOAD	Load data from a file.	<i>File Operations</i> (page 3-157)
	SAVE	Save data to a file.	
	PRINT	Prints the screen image.	<i>Screen Copy</i> (page 3-181)
	MACRO	Shows a menu listing all macros.	For installing macros, contact your local Tektronix sales office.
	MACRO SETUP	Shows a menu to configure macros.	

## Menu Operations

This section describes basic operations of the analyzer menus and how to select menu items and input numeric values.

### Menu Item Information

Up to nine soft keys can be displayed down the right side of the screen (see Figure 2–12). Cancel - Back is always displayed at the top, and the other eight keys select menu items.



**Figure 2-12: Example menu item display**

**NOTE.** When the setting is prohibited or is not available, the item is displayed in gray.

**Menu Item Types** The different types of menu items are shown in Figure 2–13.



**Numeric entry**

The current value of parameter is displayed. To change the value, press the associated side key and use the general purpose knob, up/down keys, or the keypad.



**Toggle**

You can switch selection items by pressing the associated side key.



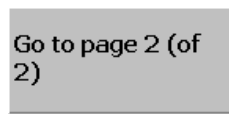
**Function execution**

The function indicated on the label is executed by pressing the associated side key. In this example, the “Channel Power” measurement is performed.



**Move to sub-menu**

If the label is followed by “...”, you can move to a lower-level menu by pressing the associated side key.



**Move between pages**

When the number of menu items is greater than seven, this menu appears. To move to the next page, press the associated side key. If you are on the last page, you will return to the first page.



**Invalid**

Menu items without labels do not cause any action.

**Figure 2–13: Menu item types**

**Numeric Input** An example numeric input field is shown in Figure 2–14. In this type of field, you can change the numeric value by turning the general purpose knob, by pressing the up/down (▲▼) keys, or by entering a value using the keypad.



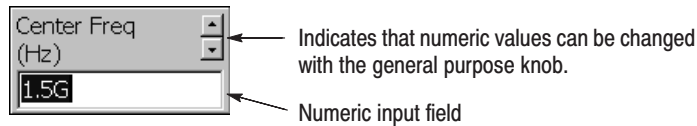
← Numeric input field

**Figure 2–14: Numeric setting menu**

### Changing a Setting Using the General Purpose Knob or the Up/Down Keys.

1. Press the side key for setting a numeric value. For example, press **FREQUENCY/CHANNEL** → **Center Freq** to set a center frequency.

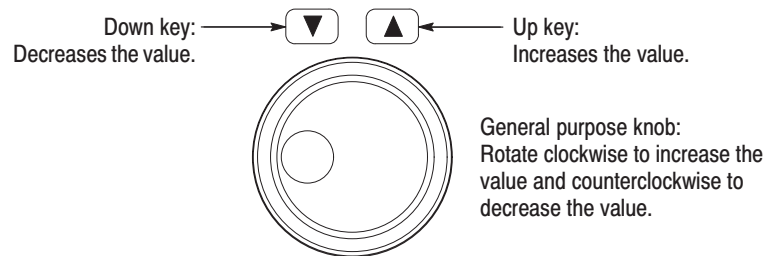
The menu item changes to the display as shown in Figure 2–15.



**Figure 2–15: Changing value with the knob**

2. Turn the general purpose knob to increase or decrease the value.

You can also use the up and down (▲▼) keys to increase or decrease a setting value, respectively.



The up and down keys have the same functions as the general purpose knob except the step size (the amount per click by which the general purpose knob changes a setting value or the amount per press for the up and down keys) as follows:

- For the general purpose knob, the step size is determined internally. You can not change the step size.
- For the up and down keys, the step size is set with the **Step Size** side key. Refer to *Changing the Step Size* on page 2–20 for the detail.

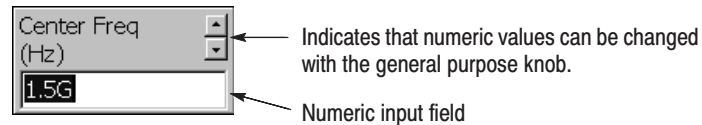
The changed value is immediately reflected on the analyzer settings and displays.



**Entering a Value Using the Keypad.** You can enter values using the front panel keypad, shown in Figure 2–17.

1. Press the side key for setting a numeric value. For example, press **FREQUENCY/CHANNEL** → **Center Freq** to set a center frequency.

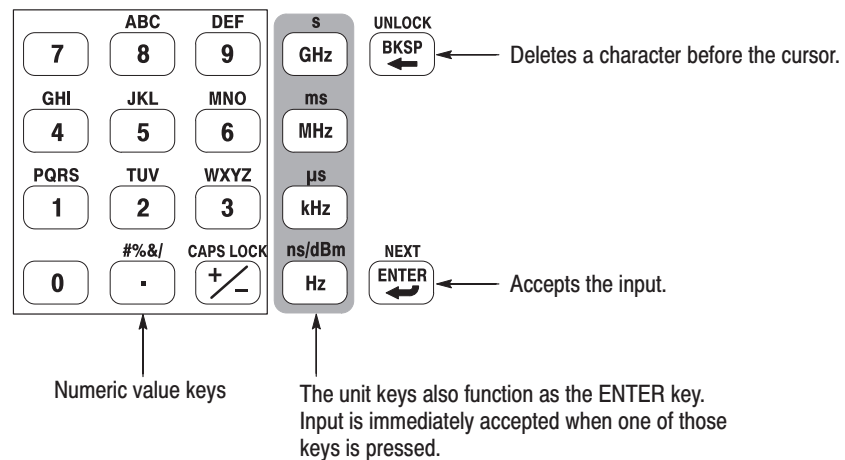
The menu item changes to the display shown in Figure 2–16.



**Figure 2-16: Changing value with the keypad**

2. Press the keys required to enter the desired numeric value. For example, to enter the frequency 123.45 MHz, press **1 2 3 . 4 5 MHz**.

To delete an entered number, press the **BKSP** (Backspace) key.



**Figure 2-17: Numeric keypad**

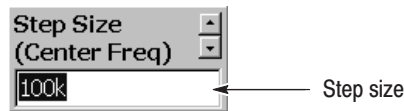
3. Confirm the input by pressing the unit key or **ENTER** key. The confirmed value is immediately reflected to the analyzer settings and display.

Press the **Cancel - Back** side key to cancel the change.

### Changing the Step Size

When using the up and down (▲▼) keys to increase or decrease a setting value, you can change the step size (the amount per press by which the up or down key changes the setting value) with the **Step Size** side key. (The step size cannot be changed for menu items that do not display **Step Size**.)

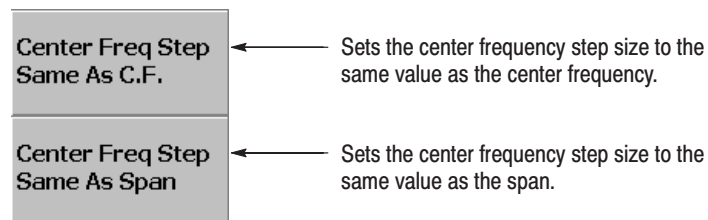
In the example shown in Figure 2–18, the step size for the start frequency is set to 100 kHz; the displayed frequency set value changes by 100 kHz step for each press of the up or down key.



**Figure 2-18: Changing the step size for the center frequency**

**Step Size for Center Frequency.** The step size is set with the **Step Size** side key. The center frequency step size can be also set with two side keys in the Frequency/Channel menu (see Figure 2–19 below).

- **Center Freq Step Same As C.F.** Useful for quickly locating harmonics of a signal seen at the center frequency.
- **Center Freq Step Same As Span.** Useful for quickly analyzing a larger frequency area without overlapping span windows.

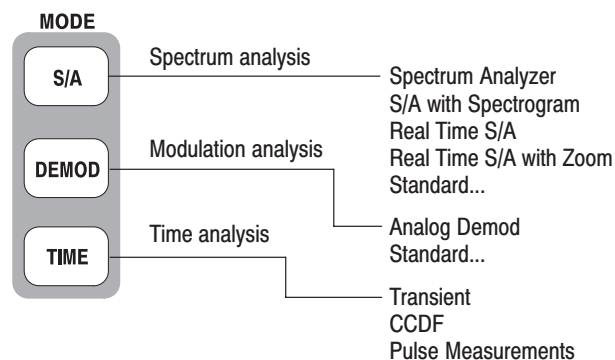


**Figure 2-19: Changing the step size for the center frequency**

## Measurement Basics

### Selecting the Measurement Mode

When you start a measurement, first select the measurement mode.



**Figure 2-20: Selecting the measurement mode**

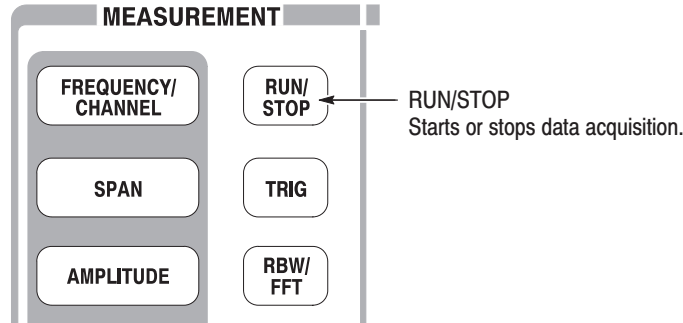
For details on each mode, refer to the section shown in Table 2-5.

**Table 2-5: Measurement modes**

Menu key	Measurement mode	Description	Reference
Spectrum analysis			
S/A	Spectrum Analyzer	General spectrum analysis	<i>Spectrum Analysis (S/A Mode)</i> page 3-1
	S/A with Spectrogram	Spectrum analysis with spectrogram	
	Real Time S/A	Real-time spectrum analysis	
	Real Time S/A with Zoom	Real-time spectrum analysis with zoom function	
	Standard...	Communication standard specific analysis	
Modulation analysis			
DEMOM	Analog Demod	Analog modulation analysis	<i>Modulation Analysis (Demod Mode)</i> page 3-27
	Standard...	Communication standard specific analysis	
Time analysis			
TIME	Transient	Time characteristics analysis	<i>Time Analysis (Time Mode)</i> page 3-43
	CCDF	CCDF analysis	
	Pulse Measurements	Pulse characteristics analysis	

### Starting/Stopping Data Acquisition

Use the **RUN/STOP** key on the front panel to start or stop data acquisition.

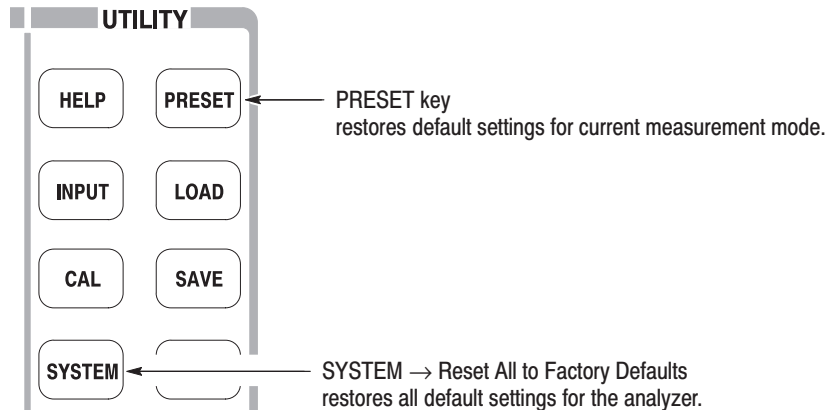


**Figure 2-21: Starting/Stopping data acquisition**

If acquisition and measurements are waiting for a trigger, or are paused/stopped, pressing this key will start the acquisition. If acquisition and measurements are running, pressing this key will stop acquisition and measurements, aborting the current acquisition.

### Restoring Default Settings

The analyzer saves the settings when it is turned off. When you turn on the analyzer, it starts with the settings as they were when it was shut down.



**Figure 2-22: Restoring default settings**

- Pressing the **PRESET** key returns the instrument settings to the factory defaults for the current measurement mode. Refer to *Appendix C* for the factory defaults.
- Pressing **SYSTEM** → **Reset All to Factory Defaults** sets all parameters for all measurements and modes to the default values.

## Setting System Parameters

The System menu sets system-wide parameters such as the display brightness, factory defaults, and GPIB address.

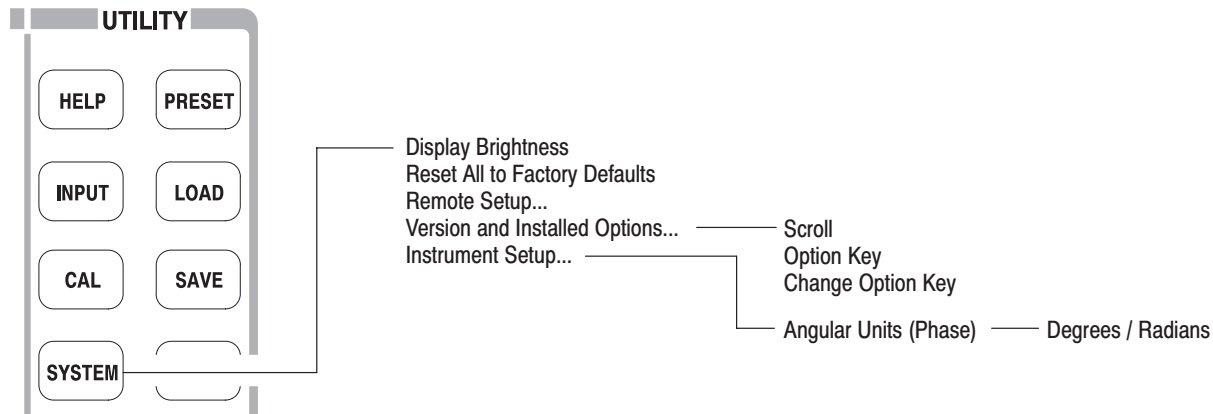


Figure 2–23: System menu

### System Menu

The System menu contains the following controls:

**Display Brightness.** Adjusts the brightness of display. Setting range: 0 to 100.

**Reset All to Factory Defaults.** Sets all parameters for all measurements and modes to the default values.

**Remote Setup...** Sets GPIB parameters. Refer to the *RSA2203A Programmer Manual* for details.

**Versions and Installed Options.** Displays the current versions of all standard and optional software, and any third party software licenses. Refer to page 2–24 for information about displaying versions and installed options.

**Instrument Setup...** Sets the fundamental parameters for measurements.

- **Angular Units.** Selects degree (default) or radian for the angular unit.

## Displaying Versions and Installed Options

You can see the system versions and installed options. For information on options for the analyzer, refer to *Appendix E: Options and Accessories*.

1. Press the **SYSTEM** key on the front panel.
2. Press the **Versions and Installed Options...** side key.  
The screen appears as shown in Figure 2–24.

Frequency: 1.5 GHz      Acquisition Length: 160  $\mu$ s  
 Span: 10 MHz  
 Input Att: 20 dB

RSA2208A Real-time Spectrum Analyzer  
 Copyright (C) Tektronix Japan, Ltd. All rights reserved.

Serial Number: DNS0001  
 Main System: 1.28      ← System version  
 Sub System: 1.4

Option	Version	Description	Option Key
05		Baseband Input	Not Required
10		High accuracy frequency reference (OCXO)	Not Required
2A		Pre-Amp Power Supply	Not Required

↑ Installed options

Python 2.0 (#8, Oct 16 2000, 17:27:58) [MSC 32 bit (Intel)] on win32  
 Copyright (c) 2000 BeOpen.com

Cancel - Back  
 Scroll  
 Option Key  
 Change Option Key

← Scroll  
 Scroll the option list when there are many options.

Option Key / Change Option Key  
 Allow you to use optional software (if available). To check on the availability of optional software, contact your local Tektronix office.

**Figure 2–24: Displaying versions and options**

The following information is shown on the screen:

- **Version**
  - Main System: Basic application software version
  - Sub System: Firmware version

- **Option**

The table shows version and name of the option installed. The “Option Key” field tells you the following information:

- Present: Indicates that you can use the option.
- Not Present: Indicates that you cannot use the option.  
For information about how to remove the protection and use the option, refer to *Enabling the Option*.

3. To exit the version display, press any front-panel key.

**Enabling the Option.**

1. Contact your local Tektronix office to order the option.  
You will receive an option key (alphanumeric code).
2. Press the **Option Key** side key (see Figure 2–24) and enter the option key using the alphanumeric keypad on the front panel.

---

**NOTE.** To input “–” (hyphen), press the “.” (period) key.

---

3. Press the **Change Option Key** side key to accept the input.

Now you can use the option on the analyzer.

## Using Windows XP

This analyzer operates under Windows XP. You can switch to a Windows XP desktop screen or execute a Windows XP application program.

### Displaying the Windows Desktop

To display the Windows desktop screen, follow these steps:

1. Connect a USB mouse and keyboard to the analyzer.  
For the USB connectors on the side panel, see Figure 2–3 on page 2–5.
2. Use a mouse to move the pointer to the bottom of screen (see Figure 2–25). The task bar appears.
3. Locate the pointer on the **RSA2203A** or **RSA2208A** icon in the task bar and right-click. A menu appears.
4. Select **Close** from the menu. The analyzer system program terminates and the Windows XP desktop screen appears.

**Switching from Windows Desktop to the Analyzer View.** To switch from the Windows desktop screen to the analyzer view display, from the task bar, select **Start** → **Program** → **TEK RTSA**. The analyzer program starts.

### Starting Windows XP Applications

When you use a mouse to move the pointer to the bottom of screen, a task bar appears (see Figure 2–25). The task bar contains Start and the analyzer application icons. Follow the Windows XP operating procedure and access Windows applications using the Start menu.

### Setting Date and Time

The screen displays the date and time managed by the Windows XP operating system. You can use the Windows time setting program to set the date and time.



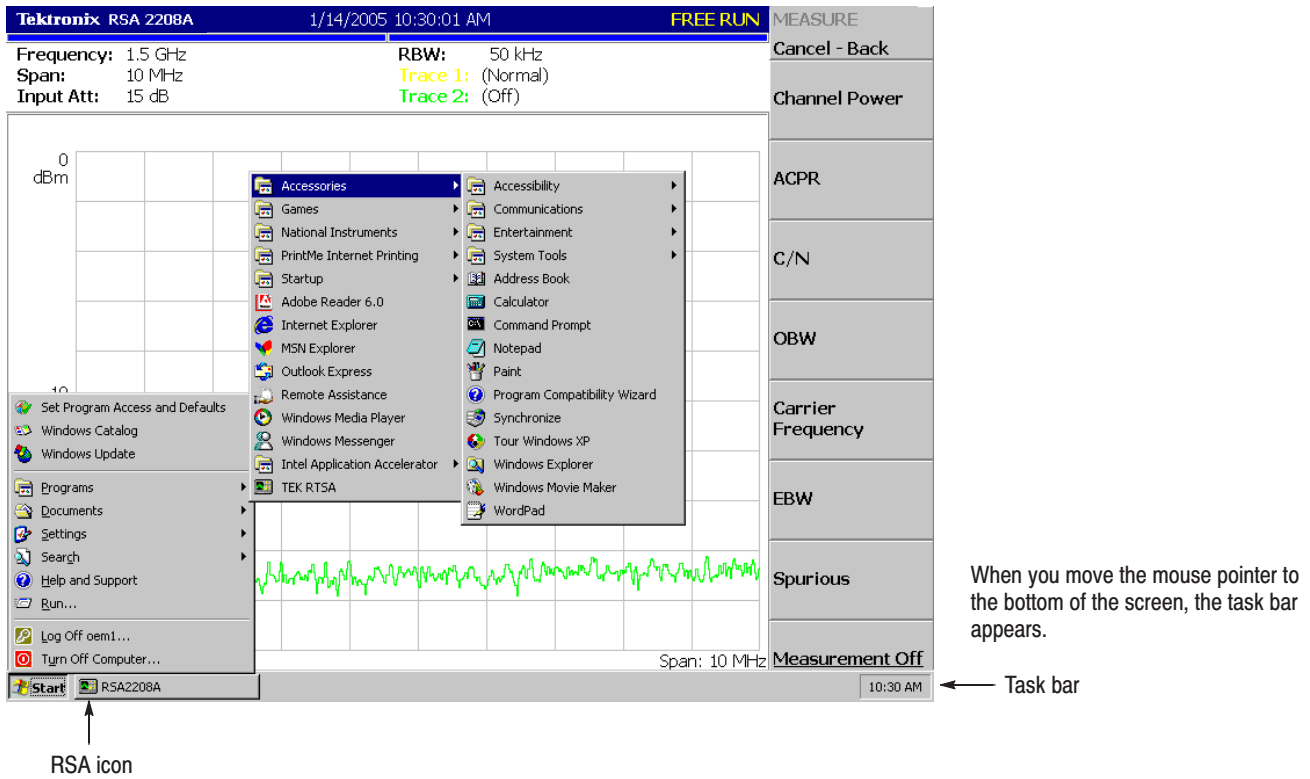


Figure 2-25: Displaying the Windows XP accessory menu



# Tutorial

This section describes how to perform basic procedures; it contains practical examples of applying power, displaying the results of measurements, and shutting off the analyzer. This section uses default settings in most examples.

- Preparations: Connecting devices and applying the power
- Displaying spectrum
- Using markers and peak search
- Using averaging and comparison displays
- Displaying spectrogram
- Spectrum analysis
- Analog modulation analysis
- Shutting off the power

You must complete the installation procedures (starting on page 1–9) before performing any of the following steps.

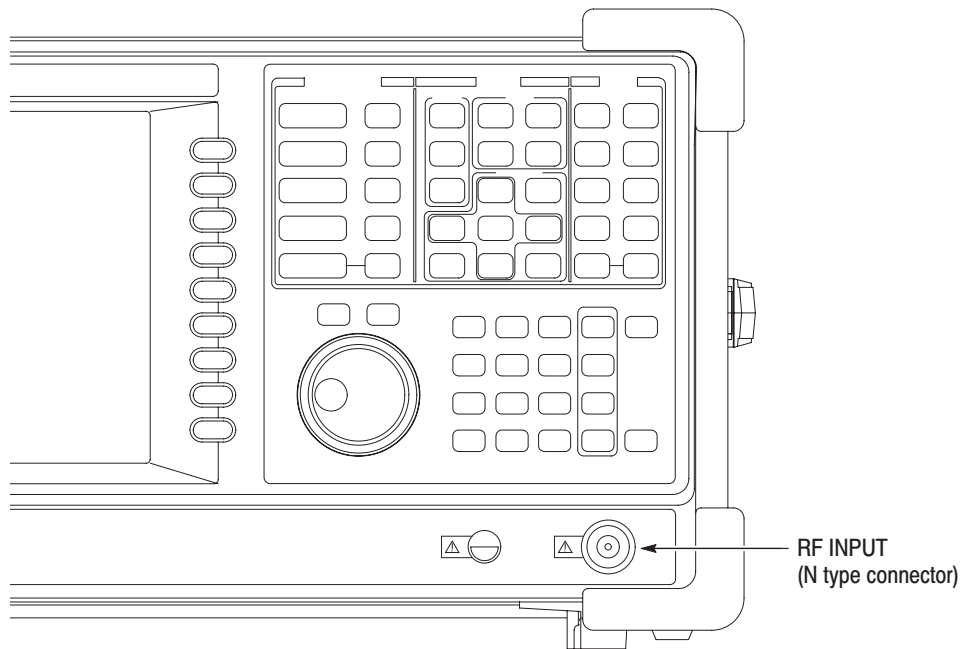
## Preparations

This tutorial uses a digitally-modulated signal. The following equipment is used as a signal source.

- Analog signal generator (example: HP8657B)
- One 50  $\Omega$  coaxial cable

### Connecting the Signal Generator

1. Connect the output of the signal generator to the RF INPUT connector on the analyzer front panel using a coaxial cable (see Figure 2–26).



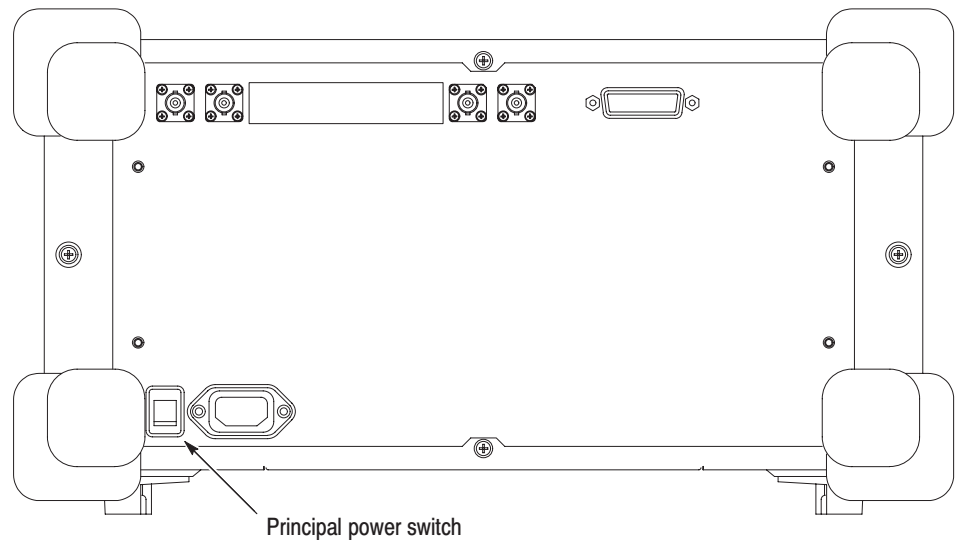
**Figure 2-26: Cable connection**

2. Set the signal generator as follows:

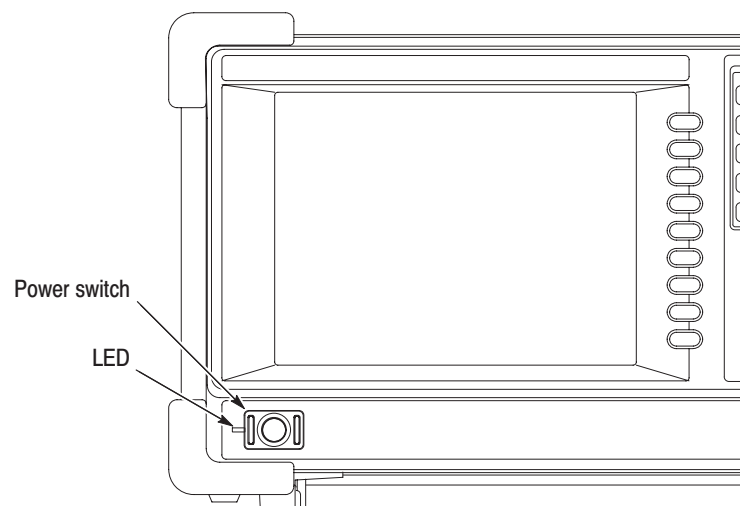
Center frequency	.....	100 MHz
Output level	.....	-10 dBm
Modulation type	.....	AM
Modulation source	.....	Internal 10 kHz
Modulation depth	.....	50%

**Applying the Power**

1. Apply power to the signal generator.
2. Turn on the principal power switch (**PRINCIPAL POWER SWITCH**) on the rear panel, as shown in Figure 2–27. The orange LED on the front panel lights.

**Figure 2-27: Principal power switch (rear panel)**

3. Turn on the power switch (**ON/STANDBY**) on the front panel, as shown in Figure 2–28.

**Figure 2-28: Power switch (ON/STANDBY)**

The initial screen shown in Figure 2–29 appears after Windows XP starts up (the background color is in white on this manual to make figures more viewable).

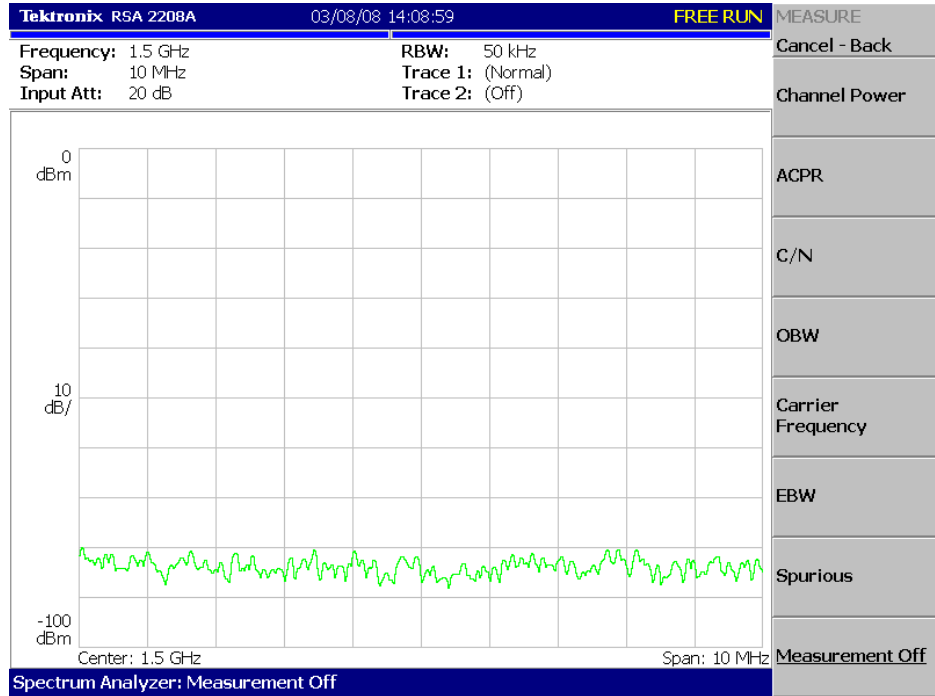


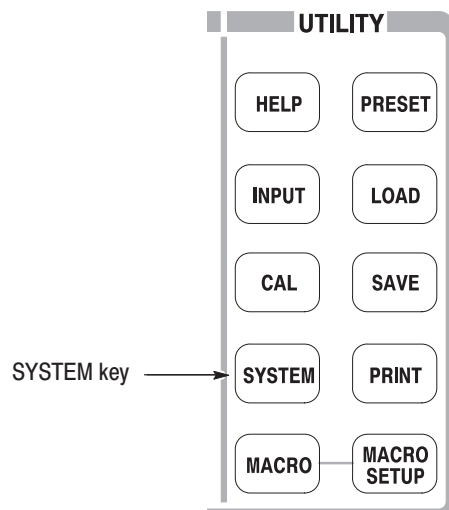
Figure 2–29: Initial screen

## Restoring Default Settings

The analyzer saves the settings when it is turned off. When you turn on the analyzer, it starts with the settings as they were when it was shut down.

This tutorial starts with the factory default settings. Perform the following steps to restore the factory default settings:

1. Press the **SYSTEM** key.

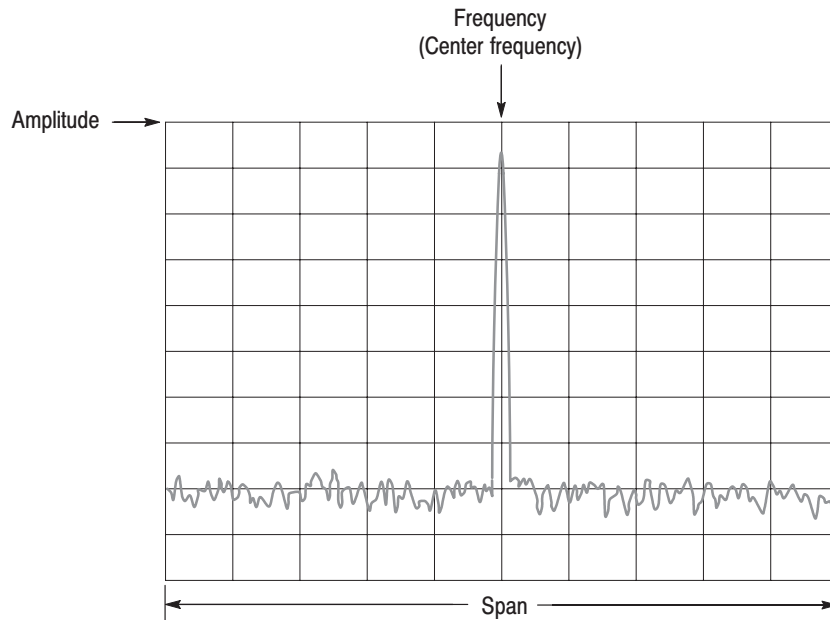


2. Press the **Reset All to Factory Defaults** side key.

The instrument is now ready to take measurements.

## Displaying Spectrum

This section describes how to set the frequency, span, and amplitude first, and then appropriately display the spectrum. Figure 2–30 shows the settings.

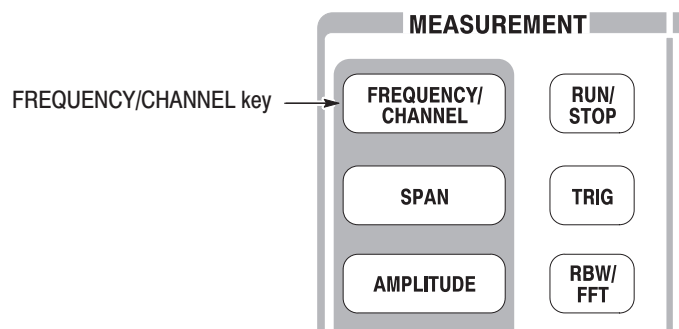


**Figure 2-30: Frequency, span, and amplitude settings**

### Setting Center Frequency and Span

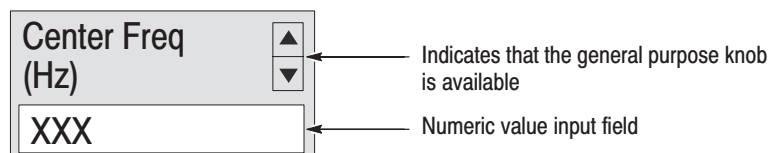
The center frequency is set to 1.5 GHz, and span is set to 10 MHz when you power on the analyzer. Change the settings of center frequency and span to display the waveform around 100 MHz.

1. Press the **FREQUENCY/CHANNEL** key on the front panel.





The FREQUENCY/CHANNEL menu, shown in Figure 2–31, is displayed on the right side of the screen. Notice that the Frequency menu item is available for entering the numeric value for center frequency.



**Figure 2–31: Menu items for numeric value input**

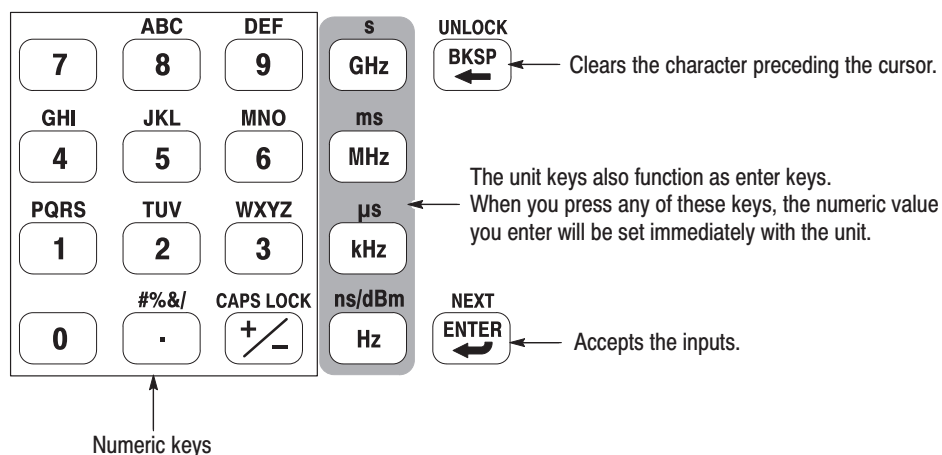
You can change the value using the general purpose knob or enter the value using the numeric value entry keypad, shown in Figure 2–32.

2. Enter the new center frequency at 100 MHz. As the interval between 1.5 GHz (current setting) and 100 MHz is wide, it is more convenient to use the keypad here.

Press **1 0 0 MHz**, in order, on the keypad.

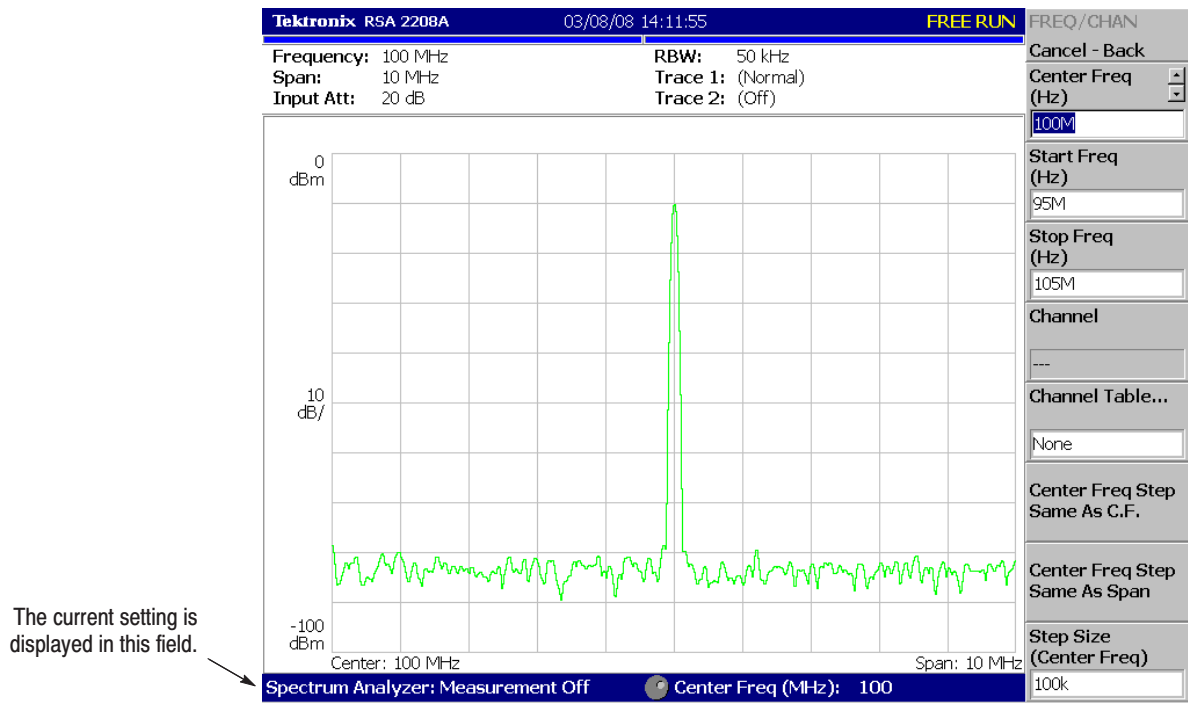
The **GHz**, **MHz**, **kHz**, and **Hz** keys also function as the enter key. When you press any of these keys, the numeric value you enter will be set immediately.

If you enter incorrect values, clear them using the **BKSP** (back space) key and then enter the correct digit.



**Figure 2–32: Numeric value entry keypad**

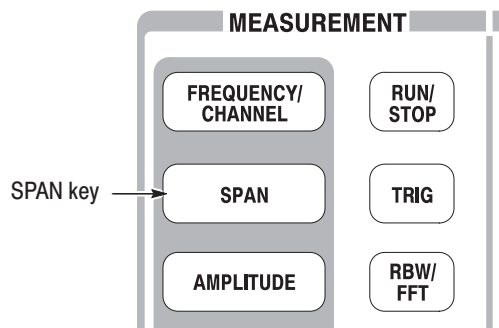
The spectrum waveform is displayed on the screen as shown in Figure 2–33. The current setting is displayed on the bottom of the screen (“Center Freq (MHz): 100” in this example).



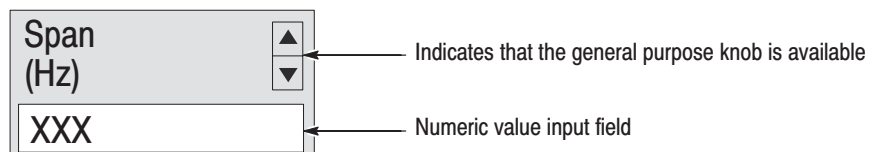
**Figure 2–33: Center frequency of 100 MHz, span of 10 MHz**

The next step is to set the span. It is currently set to 10 MHz as the default value. Change the setting to 20 kHz.

3. Press the **SPAN** key on the front panel.

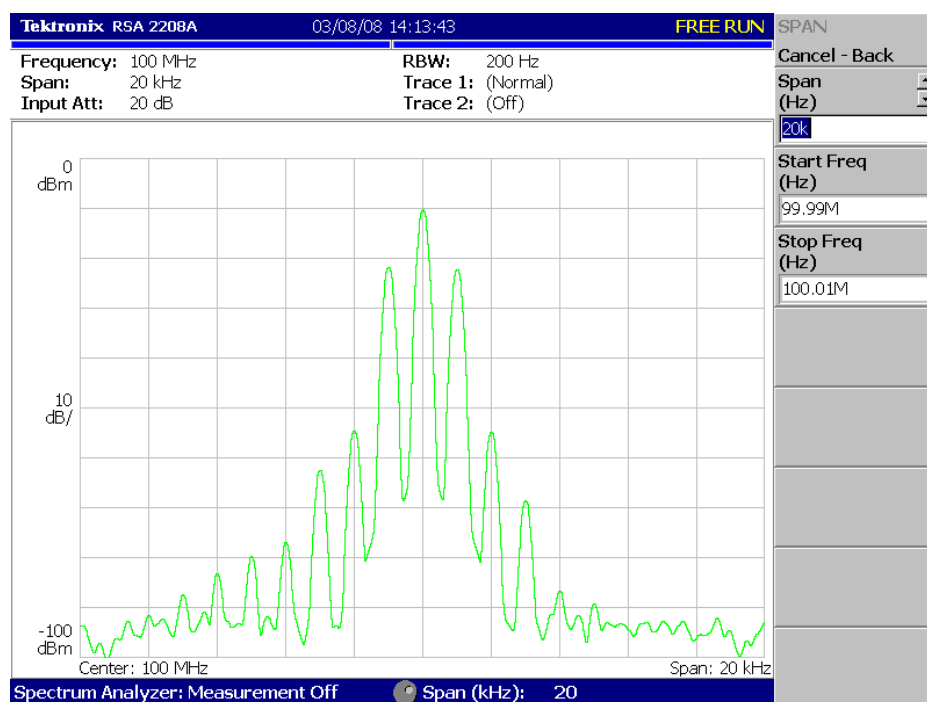


The **Span** menu item is selected.



4. Turn the general purpose knob to the left to select **20k**.  
The hardware is set with the selected value immediately.

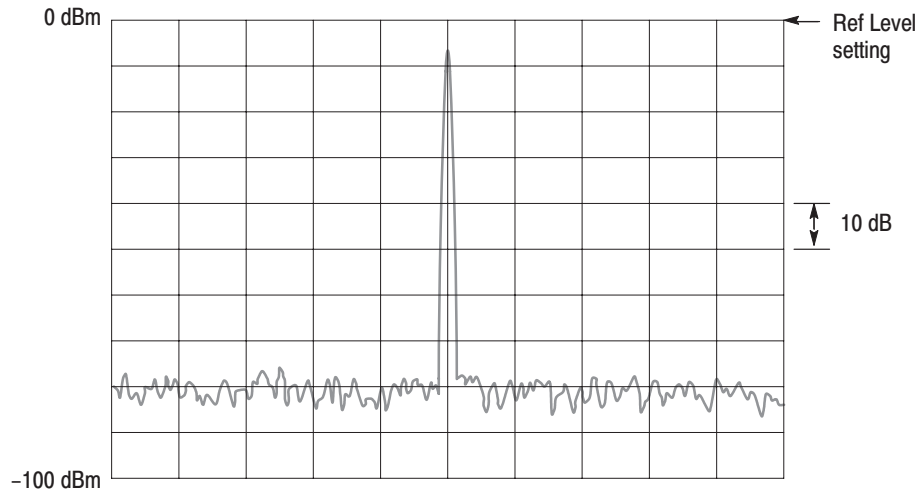
The spectrum waveform is displayed on the screen as shown in Figure 2–34.



**Figure 2–34: Center frequency of 100 MHz, span of 20 kHz**

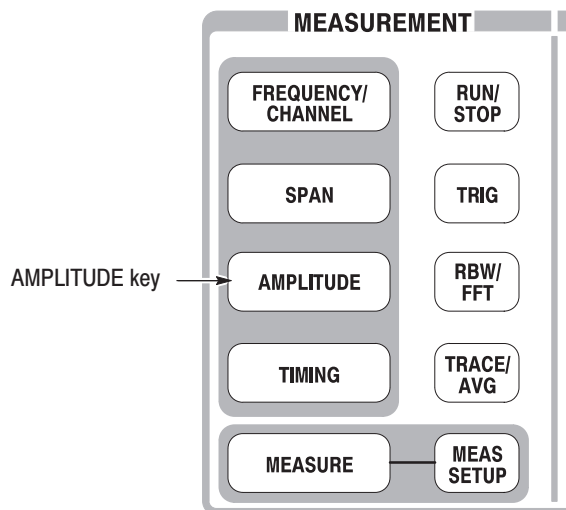
### Setting Up Amplitude

In Figure 2–35, the vertical scale shows the spectrum view, set up for 10 dB per division. Ref level is the maximum value of the vertical axis, and it is set to 0 dBm when the analyzer is powered on. Observe the change in the waveform as you change this setting in the following procedure:

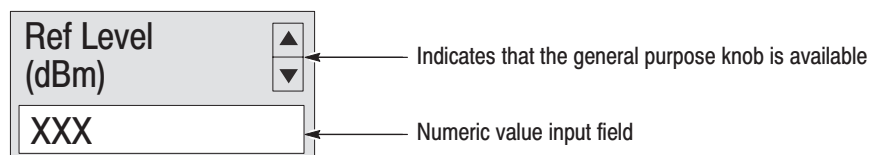


**Figure 2-35: Setting amplitude**

1. Press the **Amplitude** key on the front panel.



The Amplitude menu is displayed on the right side of the screen. Notice that the Ref Level item is available for entering amplitude (see Figure 2–36).

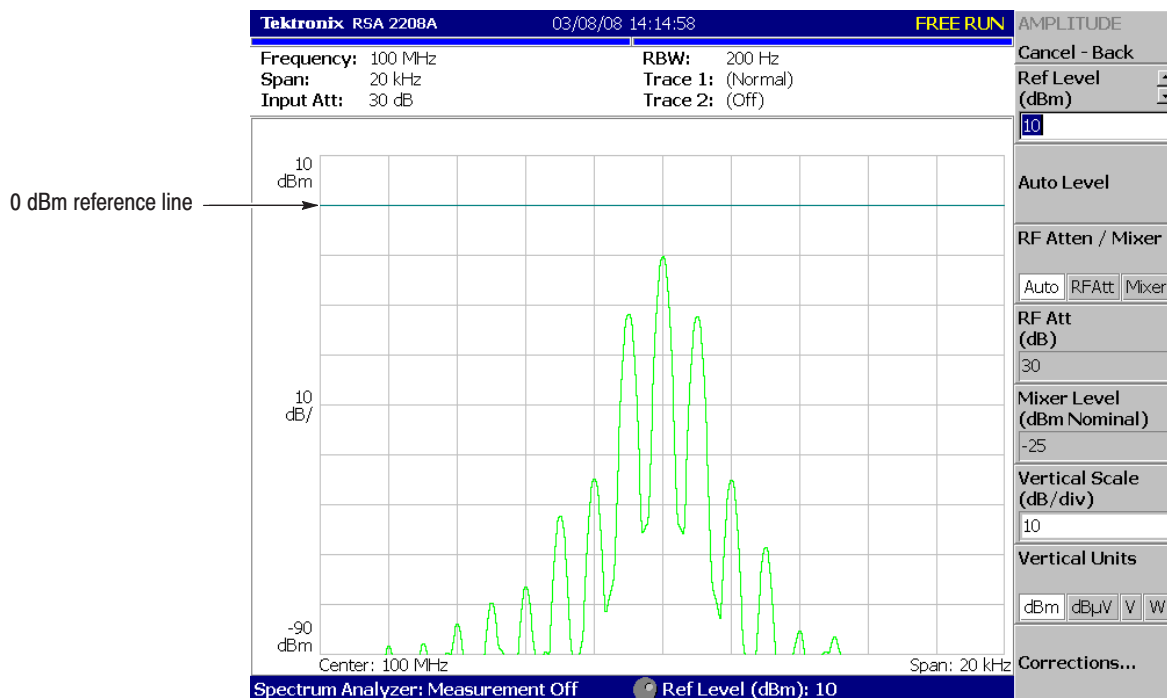


**Figure 2-36: Menu items for numeric value input**

2. Observe the changes in the waveform as you turn the general purpose knob.
  - As you turn the knob to the right, the amplitude increases and waveform shifts to a relatively lower position.
  - As you turn the knob to the left, the amplitude decreases and waveform shifts to a relatively higher position.

In Figure 2-37, the amplitude is set to 10 dBm. When the amplitude is set to 0 dBm or higher, a blue standard line is displayed indicating 0 dBm.

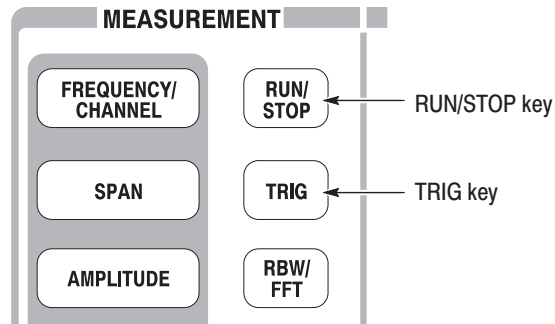
3. Set the Ref Level back to 0 dBm after confirming the amplitude operation.



**Figure 2-37: Reference level of 10 dBm**

## Starting and Stopping Data Acquisition

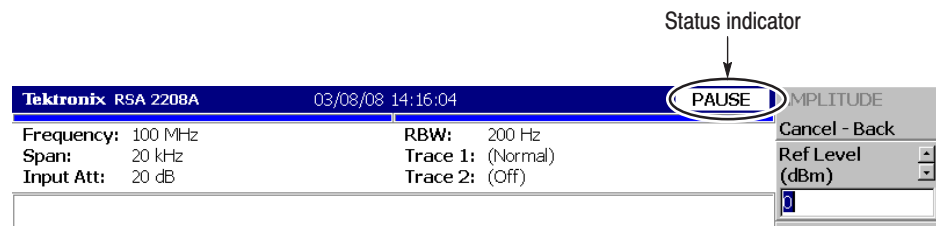
Use the **RUN/STOP** key to start or stop data acquisition. There are two acquisition modes: the continuous mode, in which data is acquired repeatedly and the single mode, in which one waveform is acquired. You can select the mode using the Trig menu.



By default, the analyzer is now acquiring data in the continuous mode.

1. Press the **RUN/STOP** key to stop data acquisition.

When acquisition stops, "PAUSE" is shown in the status indicator on screen (see Figure 2–38).



**Figure 2-38: Status indicator**

2. Acquire data in the single mode using the following steps:
  - a. Press the **TRIG** key on the front panel.
  - b. Press the **Repeat...** side key and select **Single**.
  - c. Press the **RUN/STOP** key to acquire data. One waveform is acquired and displayed every time you press the key.
3. Press the **Repeat...** side key again and select Continuous to return to the continuous mode.

When acquisition starts, "READY" is displayed in the status indicator, indicating that the analyzer is ready for trigger.

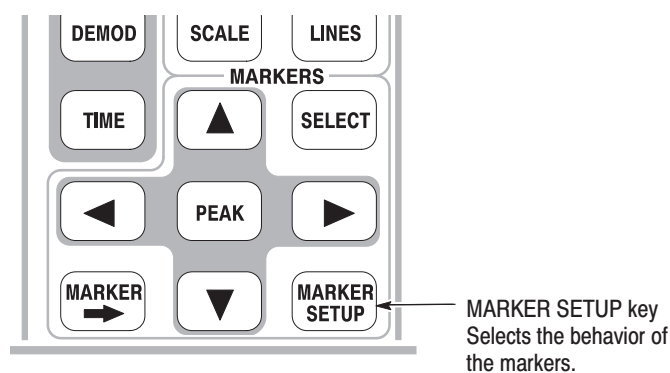
## Using Markers and Peak Search

The markers are used to measure amplitude or frequency (and also to find the peak signal).

One or two markers can be displayed as Marker 1 and 2. To measure an absolute value, only Marker 1 is used, and that is called “single marker mode.” To measure a relative value, Markers 1 and 2 are used, and that is called “delta marker mode.” To position the markers, use the general purpose knob or the numeric input keypad.

### Measuring with a Single Marker

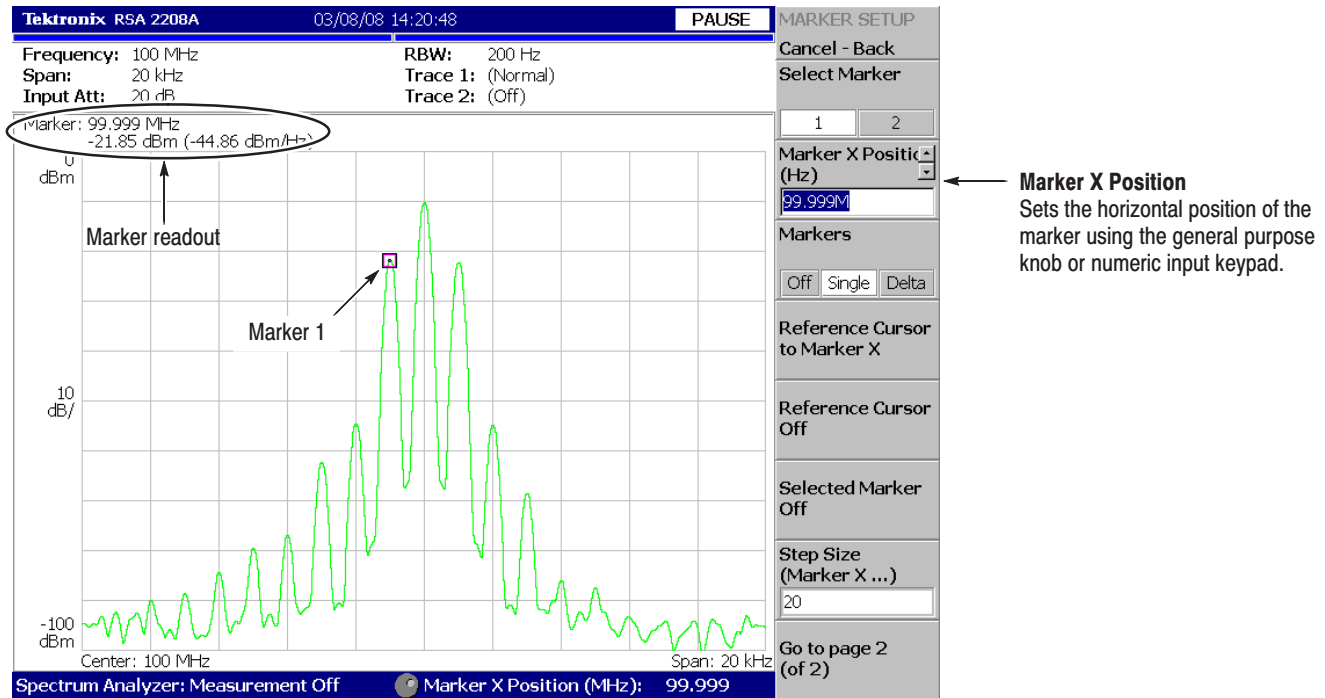
1. Press the **MARKER SETUP** key on the front panel.



2. Press the **Markers** side key to select **Single**.

The marker (□) appears at center on the waveform.

3. The **Marker X Position** menu item is selected by default. Turn the general purpose knob to move the marker to a measurement point (see Figure 2–39).



**Figure 2-39: Measurement with a single marker**

### Measuring Difference with Delta Marker

Turn on Marker 1 and 2 to measure the difference in amplitude and frequency. On the screen, the symbol “□” represents the active marker and “◇” represents the fixed marker. You can operate only the active marker.

1. Press the **MARKER SETUP** key on the front panel.
2. Press the **Markers** side key to select **Delta**.  
The fixed marker (◇) appears at the active marker position.
3. Make sure that **1** (Marker 1) is selected in the **Select Marker** menu item. This means that Marker 1 is the active marker.
4. The **Marker X Position** menu item is selected. Using the general purpose knob or the numeric input keypad, move the marker to a reference point (see Figure 2-40).



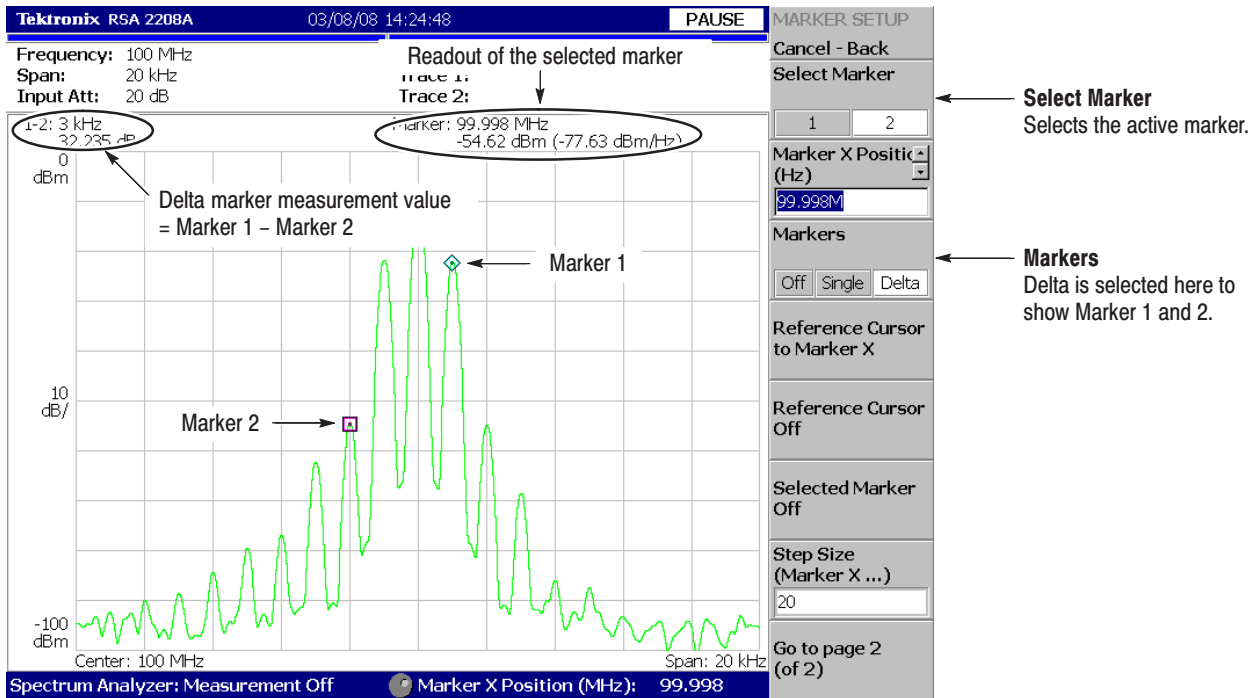


Figure 2–40: Measurement with the delta marker

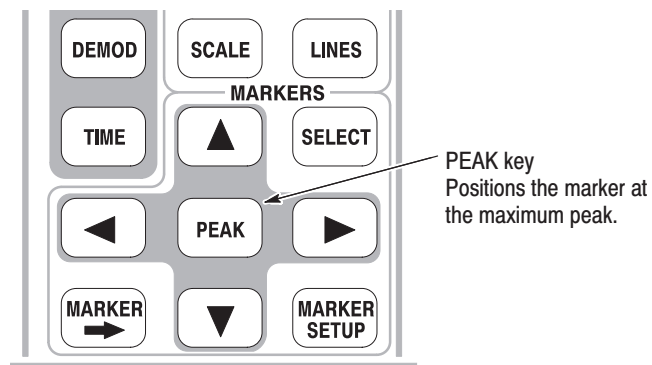
5. Press the **Select Marker** side key (top) to select **2**, making Marker 2 active.  
 You can also select the marker using the **MARKERS: SELECT** key on the front panel. The **MARKERS: SELECT** key and the **Select Marker** side key have the same function.
6. The **Marker X Position** menu item is selected. Using the general purpose knob or the numeric input keypad, move the marker to a measurement point (see Figure 2–40).  
 The difference between the two marker positions is indicated in the upper left part of the screen:
7. Press the **Markers** side key to select **Single**.  
 The analyzer returns to the single marker mode.

## Searching for the Peak

Measure the frequency interval between the maximum intensity spectrum and the peak to its left by using the delta marker and peak search functions together.

1. Press the **PEAK** key on the front panel.

Marker 1 moves to the maximum intensity spectrum.



2. Press the **Markers** side key to select **Delta**.

The fixed marker ( $\diamond$ ) appears at the active marker position.

3. Press the **Select Marker** side key to select **2**, making Marker 2 active.
4. Press the marker right key ( $\blacktriangleright$ ) to move the marker to the next signal peak to the right. Try it several times.
5. Press the marker left key ( $\blacktriangleleft$ ) to move the marker to the next signal peak to the left. Try it several times.
6. Using the marker left or right key, put the marker to the measurement peak.

The difference between the two marker positions is shown in the upper left part of the screen (see Figure 2-41).

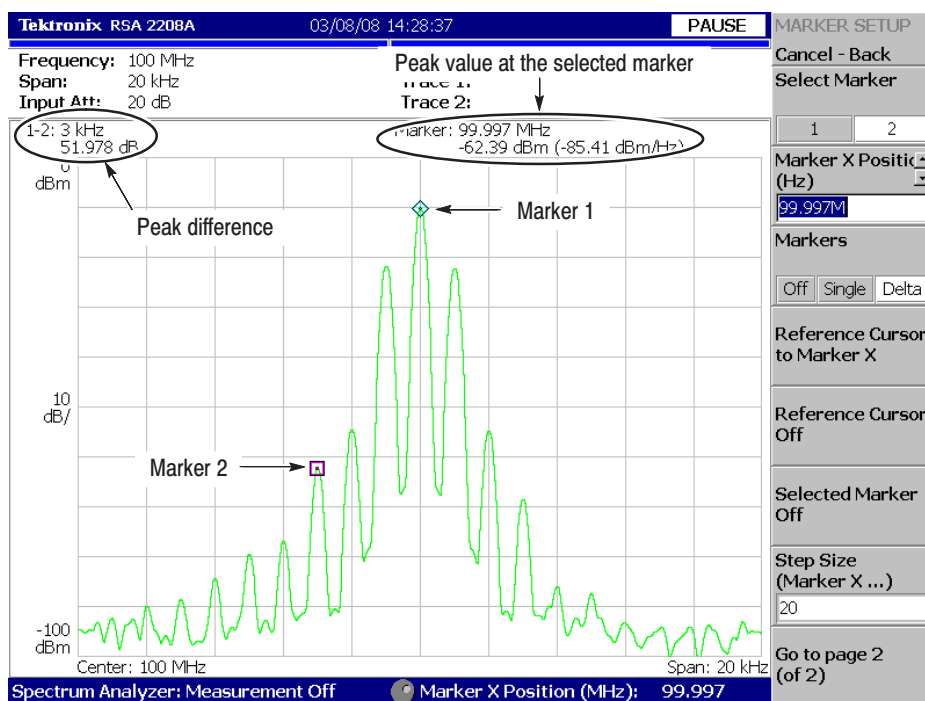


Figure 2-41: Searching for the peak

7. Press the **Markers** side key to select **Off**. Both markers disappear.

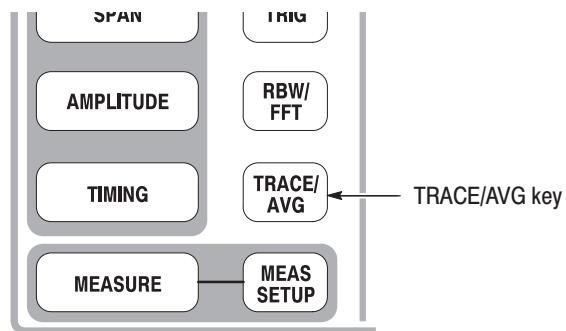
## Using Averaging and Comparison Displays

This section describes how to use the averaging function, which displays the waveform with reduced noise. The averaged waveform can be displayed with the original waveform.

### Averaging

There are several averaging methods; select RMS (Root-Mean-Square) in this example.

1. Press the **TRACE/AVG** key.



2. Press the **Trace Type** side key to select **Average**.
3. Press the **Number of Averages** side key to specify how many traces are accumulated to create the averaged waveform.

In this example, enter 64 with the numeric keypad.  
Press **6 4 ENTER** in order.

4. Press the **RUN/STOP** key on the front panel to acquire waveform.

The averaged waveform is displayed on the screen. The average count is shown in the upper right part of the screen (see Figure 2–42). When the waveform is acquired in the free run mode, the averaging is done with exponential RMS (root-mean-square). This method continues the average with an exponential weighting applied to old values, using the number of averages (64 in this example) as the weighting factor.

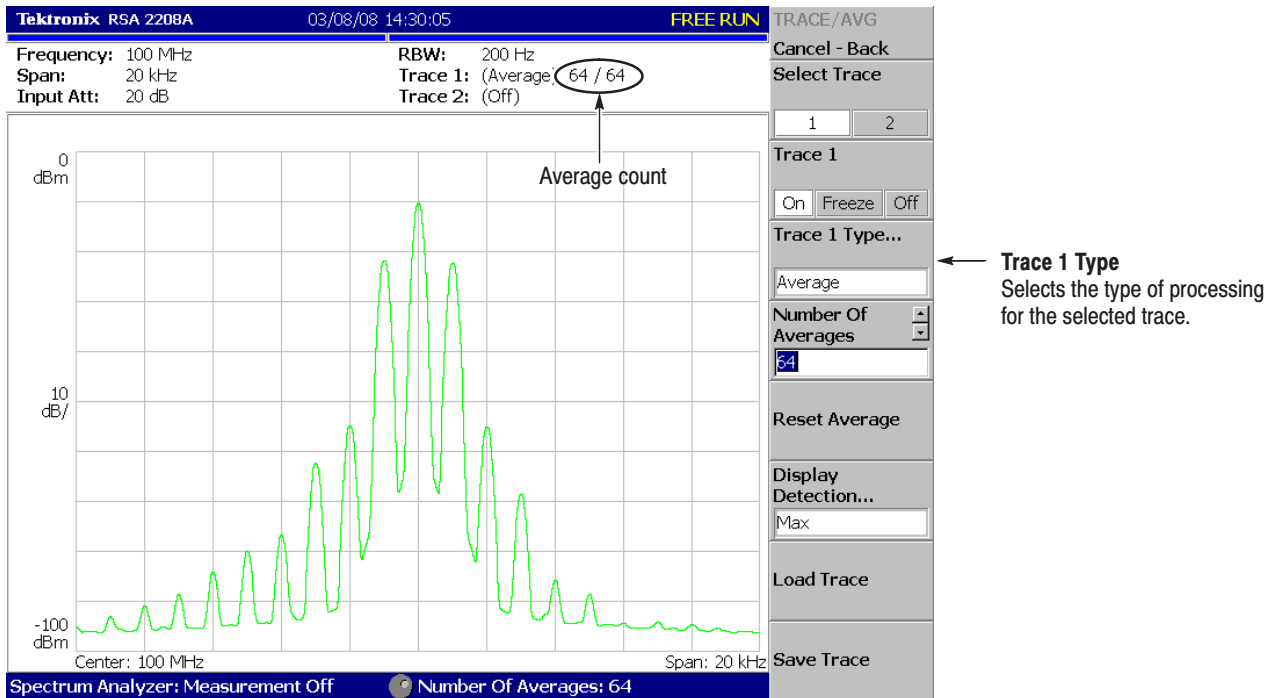


Figure 2–42: Comparing a new waveform with an averaged waveform

5. Press the **Reset Average** side key to restart averaging.

## Comparison Display

You can display two different types of traces concurrently on the screen. In this procedure, you will display the currently acquired waveform and an averaged waveform for comparison.

1. Press the **TRACE/AVG** key on the front panel.
2. Make sure that **1** (Trace 1) is selected in the **Select Trace** menu item.
3. Press the **Trace Type...** side key and select **Normal** to define Trace 1 as the currently acquired waveform.
4. Press the **Select Trace** side key to select **2** (Trace 2).
5. Press the **Trace 1 Type...** side key and select **Average** to define Trace 2 as the averaged waveform.
6. Press the **RUN/STOP** key on the front panel to acquire waveform.

The currently acquired waveform (Trace 1 in yellow) is displayed with the averaged waveform (Trace 2 in green). See the display in Figure 2–43.

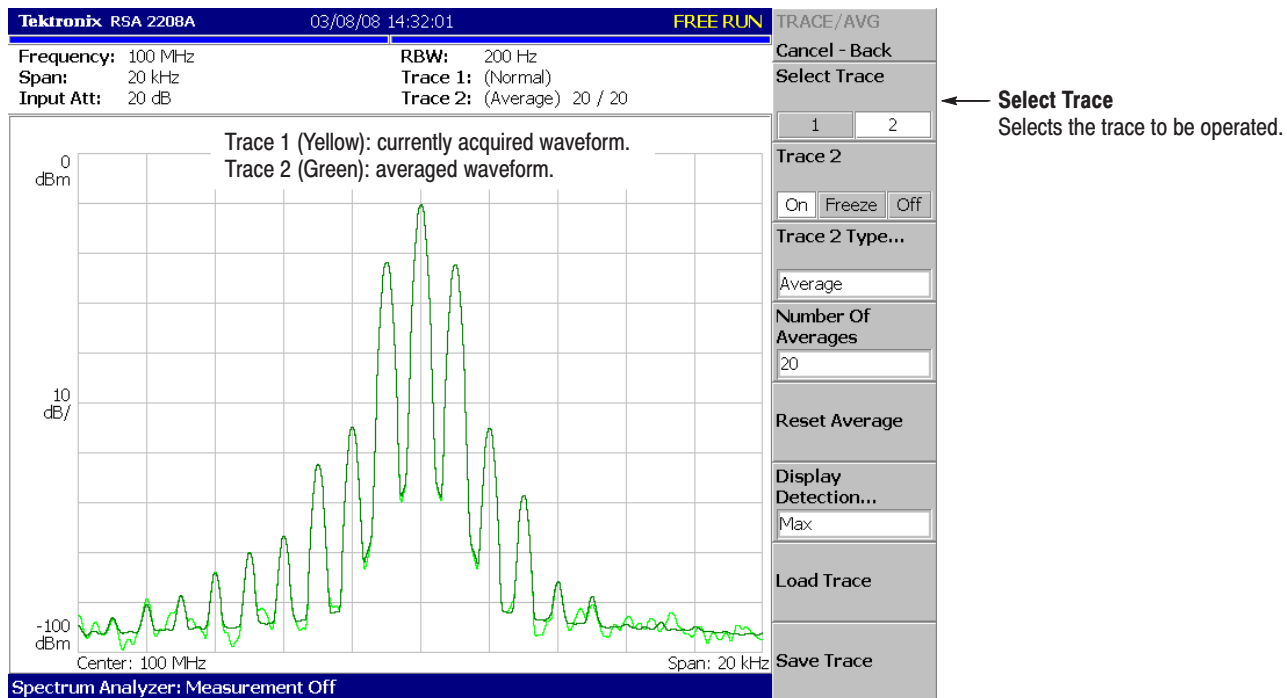


Figure 2–43: Comparison display with averaged waveform

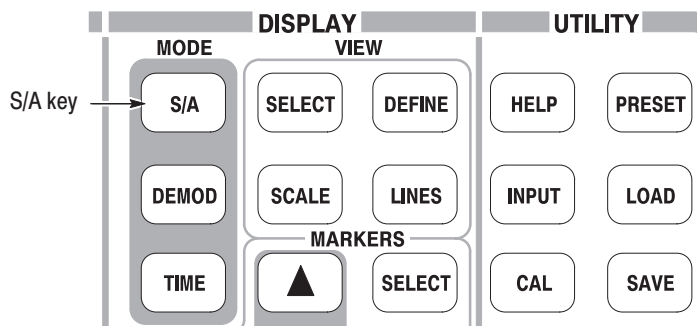
7. Press the **Trace 2 Type...** side key again and select **Off** to remove Trace 2.

## Displaying a Spectrogram

The spectrogram view is a useful tool to observe spectrum changes in time series in a three-dimensional view. The horizontal and vertical axes indicate frequency and frame number, respectively, and the color axis represents amplitude.

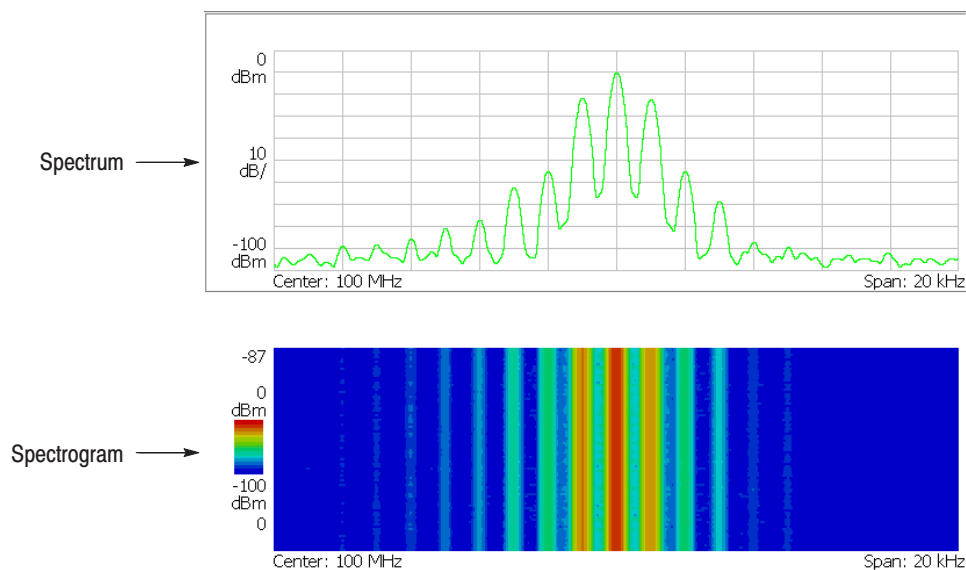
Display the spectrogram using the following steps:

1. Press the MODE: S/A key.



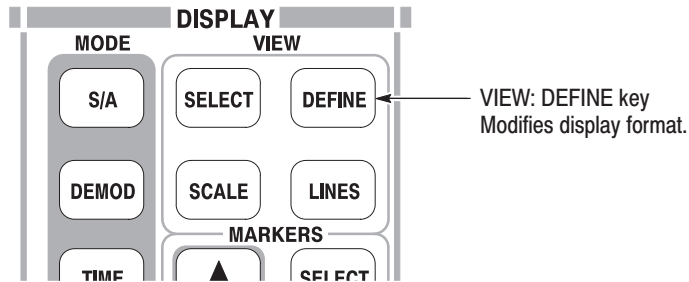
2. Press the **S/A with Spectrogram** side key.
3. If no waveform is displayed, press the **RUN/STOP** key to acquire data.

The spectrum and spectrogram are displayed concurrently (see Figure 2–44).

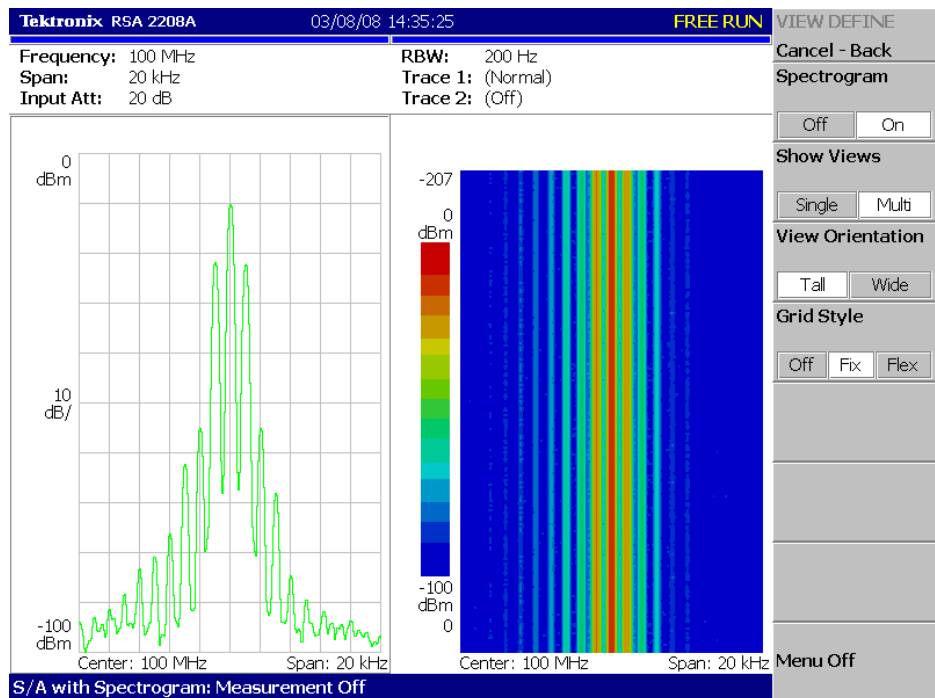


**Figure 2–44: Concurrent display of spectrum and spectrogram**

4. Display the spectrum and spectrogram side-by-side:
  - a. Press the VIEW: **DEFINE** key.



- b. Press the **View Orientation** side key to select **Tall**.



**Figure 2-45: Tall display of spectrum and spectrogram**

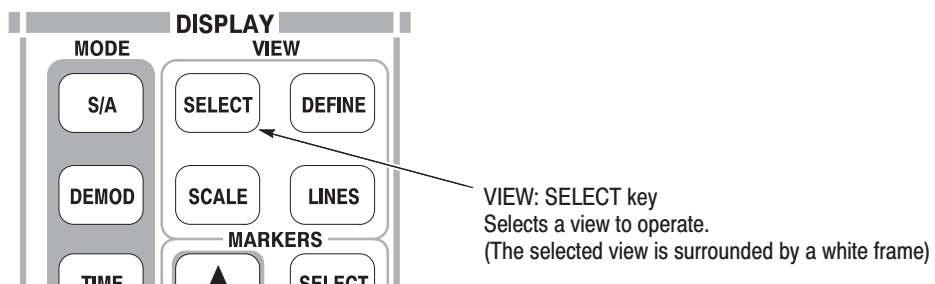
- c. Press the **View Orientation** side key to select **Wide**.



5. Display spectrogram only:

- a. Press the **VIEW: SELECT** key and then select the spectrogram on the display.

The selected view is framed in white on screen.



- b. Press the **VIEW: DEFINE** key and then press the **Show Views** side key to select **Single**.

Only the spectrogram is displayed (see Figure 2–46).

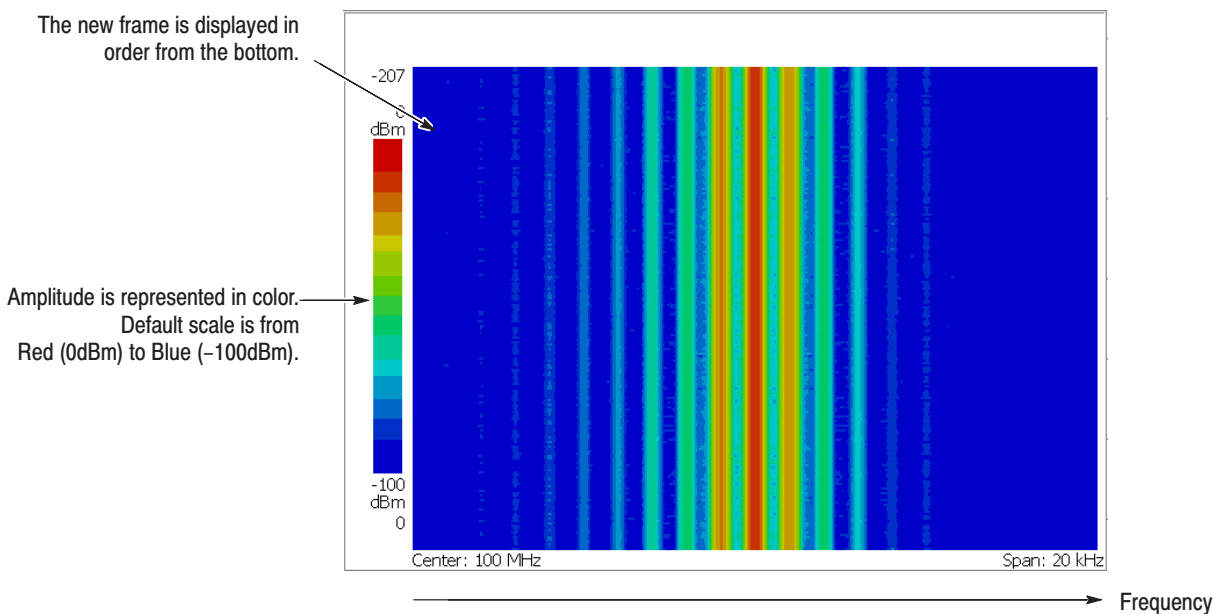


Figure 2–46: Spectrogram view

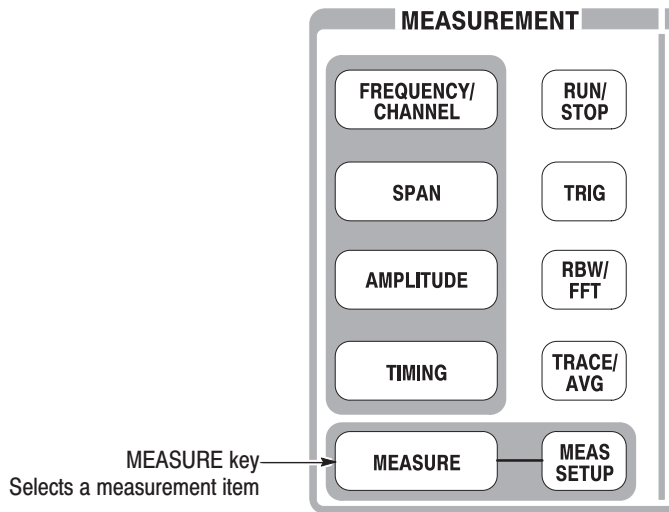
- c. Press the **Show Views** side key again to return to **Multi**.

## Spectrum Analysis

There are several measurement items in the spectrum analysis, such as ACPR (Adjacent Channel Leak Power Ratio), C/N (Carrier vs. Noise Power Ratio), and OBW (Occupied Band Width). These items enable you to perform measurements using simple key operations. Here measure channel power and carrier frequency as examples.

### Measuring Channel Power

1. Press the **MEASURE** key on the front panel.



Measurement items are displayed in the menu on the right side of the screen.

2. Press the **Channel Power** side key.

A band power marker, indicating measurement range, is displayed on the spectrum waveform. The measurement result is displayed below the waveform (see Figure 2–47).

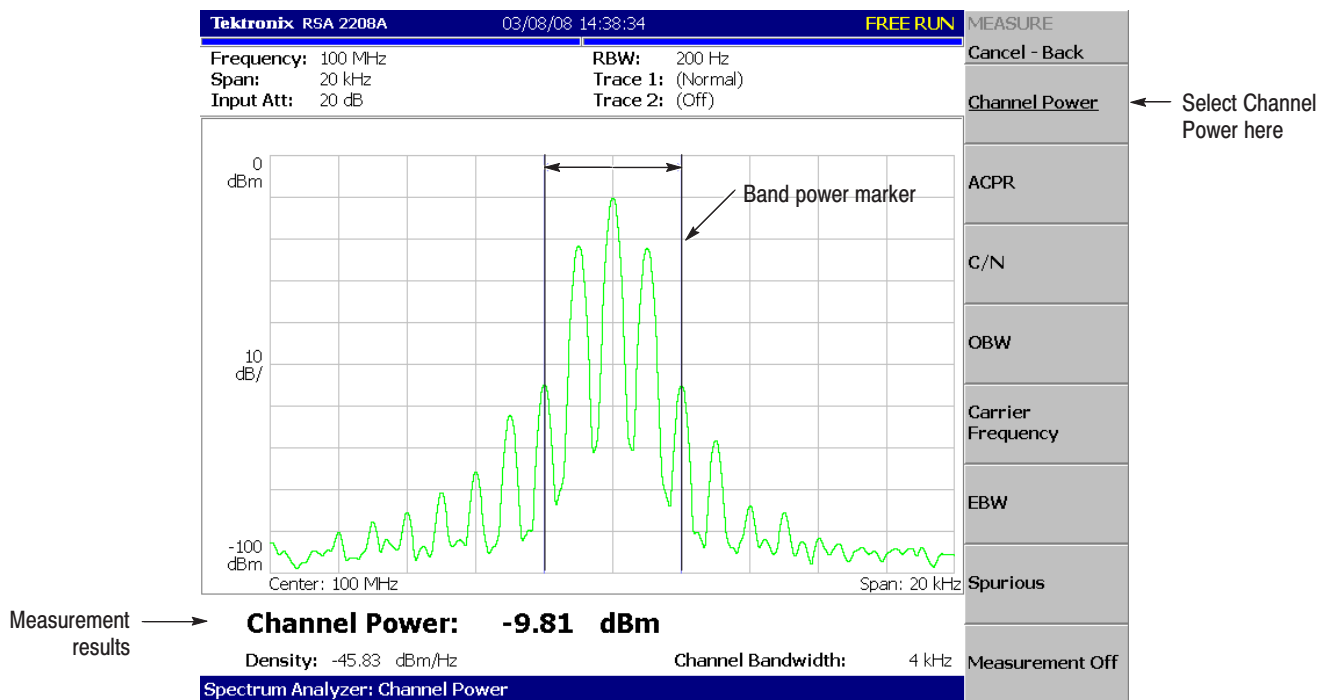


Figure 2–47: Channel power measurement

### Changing a Measurement Parameter

Change a measurement parameter:

1. Press the **MEAS SETUP** key on the front panel.
2. The **Channel Bandwidth** menu item is selected. Using the general purpose knob, set the measurement range to 40 kHz for example. See the display in Figure 2–48.

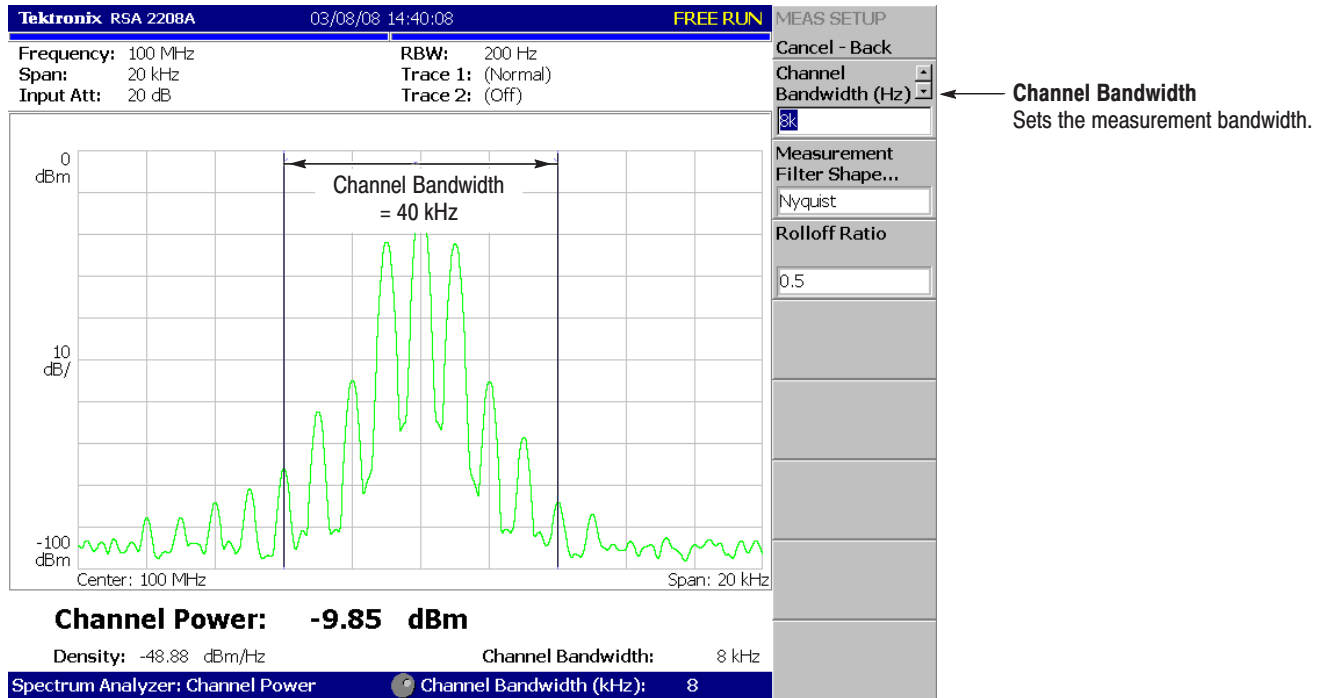


Figure 2–48: Channel power measurement (Channel Bandwidth = 40 kHz)

## Measuring Carrier Frequency

Carrier frequency can be measured accurately, using the counter function:

1. Press the **MEASURE** key on the front panel.
2. Press the **Carrier Frequency** side key.

The measurement result is displayed at the bottom of the screen (see Figure 2–49).

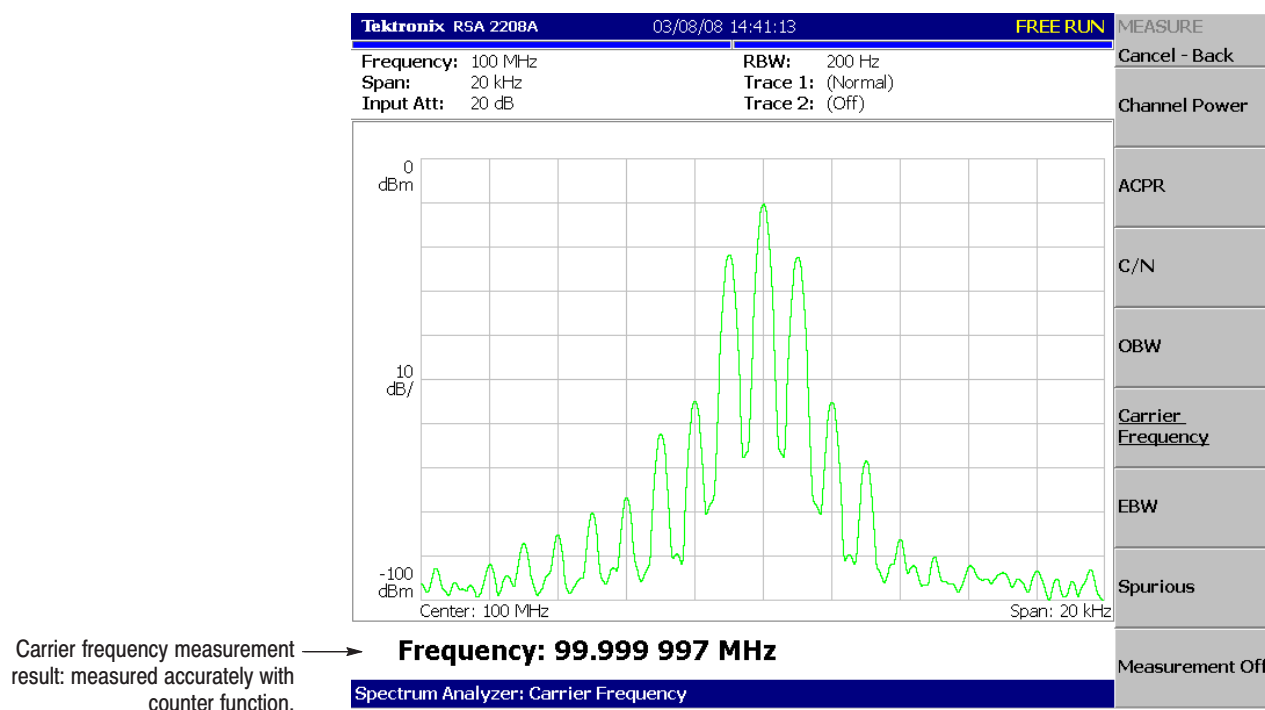


Figure 2–49: Carrier frequency measurement

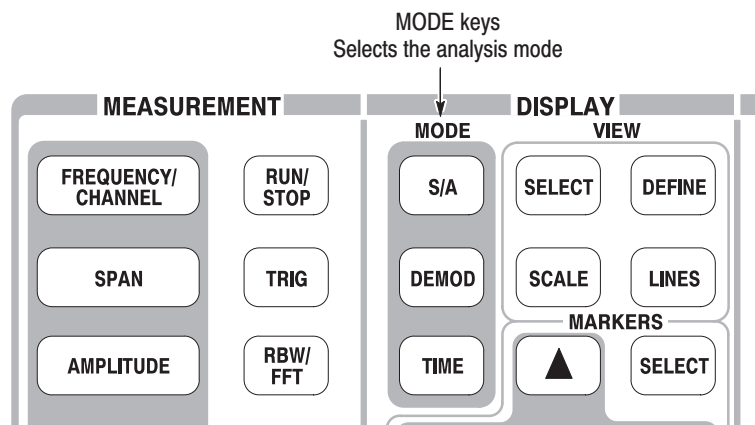
## Analog Modulation Analysis

This section describes how to analyze a modulated signal. Settings are the same as those in the previous section; center frequency at 100 MHz, span of 20 kHz, and amplitude of 0 dBm.

### Selecting Analysis Mode

The analyzer functions are classified into three functional groups, selected using the Mode keys (see Figure 2–50):

- Spectrum analysis      **MODE: S/A**  
Performs general spectrum analysis. All operations in the tutorial up to this point have been performed in this mode.
- Modulation analysis    **MODE: DEMOD**  
Performs analog modulation analysis.
- Time analysis            **MODE: TIME**  
Performs time characteristic analysis, including CCDF measurement.



**Figure 2-50: MODE keys**

The measurement procedures for modulation analysis and the time analysis are similar. Select the analog modulation analysis here:

1. Press the **DEMOM** key on the front panel.
2. Press the **Analog Demod** side key.

## Selecting a Measurement Item

Observe an AM signal change in time series as an example.

1. Press the **AM Demod** side key.
2. Press the **MEAS SETUP** key on the front panel to set the measurement parameter.
3. Press the **RUN/STOP** key to acquire the signal (see Figure 2–51).

Three views are displayed on the screen in the Demod mode:

- *Overview:* All data of the specified block are displayed in the time domain. The measurement range indicated by the green underline is specified in this view.
- *Main view:* Displays the measurement result and waveform of the range specified in the overview (they may be displayed in separate views). In this case, level changes of I and Q signals are displayed as the yellow and green traces, respectively, in the main view.
- *Subview:* Spectrum is displayed as an auxiliary view by default. You can specify the range in the overview to create the spectrum for the subview.

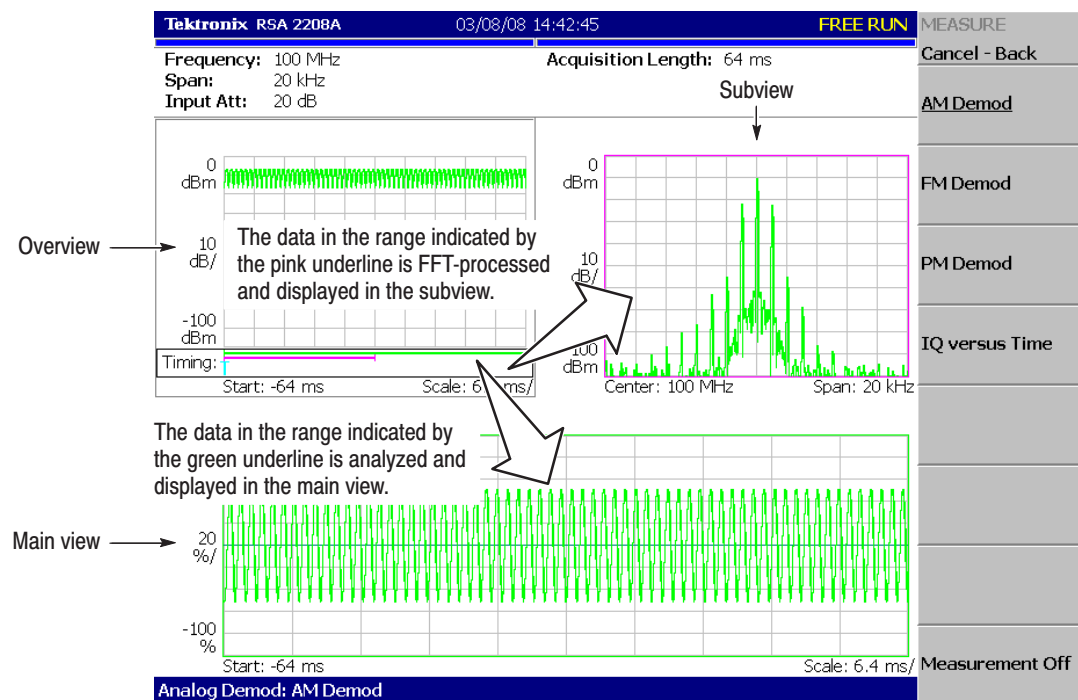
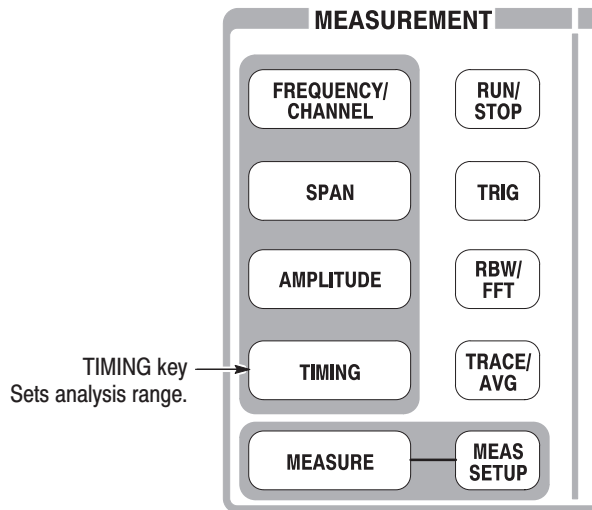


Figure 2–51: AM signal measurement

## Setting Analysis Range

Set an analysis range, which will be displayed with a green underline in the overview.

1. Press the **TIMING** key on the front panel.



Two vertical green lines appear, indicating the analysis range, shown in Figure 2–52.

2. Press the **Acquisition History** side key to specify the number of the block to be analyzed. Leave it at "0" (the latest block), its default value.
3. Press the **Analysis Length** side key and specify the time length of the analysis range. For example, enter **32 ms** using the numeric keypad.
4. Press the **Analysis Offset** side key and specify the starting point of the range. For example, enter **24 ms** using the numeric keypad.



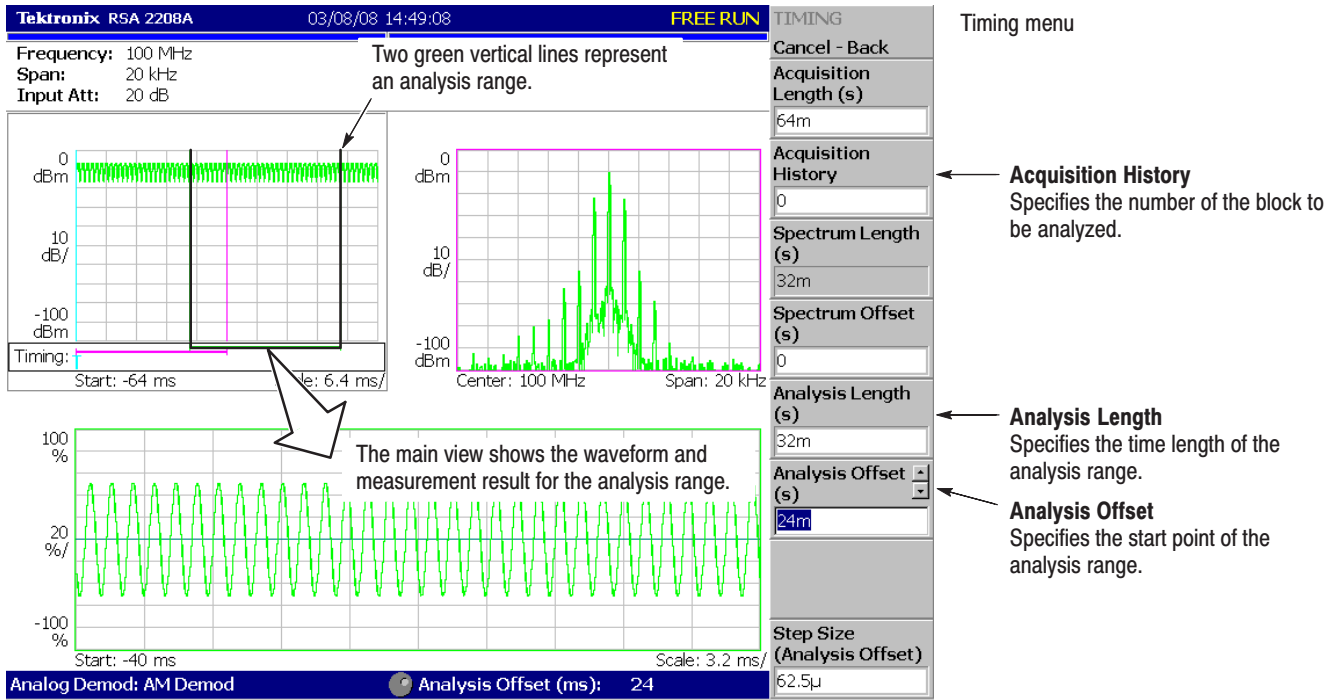
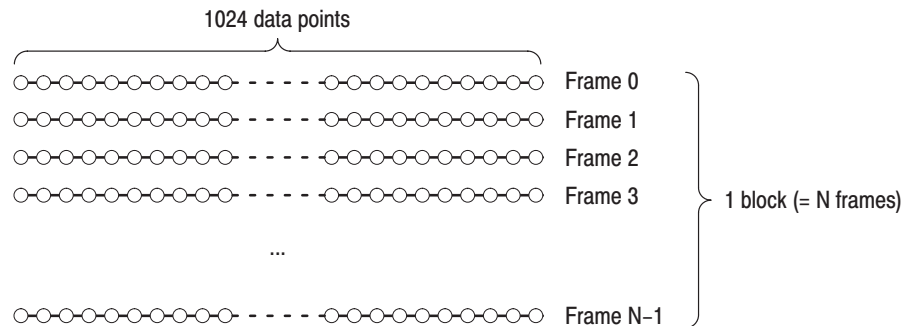


Figure 2-52: Analysis range settings

## Setting the Acquisition Length

One frame consists of 1024 data points and one block consists of several frames. Data are acquired in block units in the Demod mode. The number of frames in one block is referred to as block size. Frame and block size are shown in Figure 2–53.



**Figure 2–53: Frame and block**

Suppose that one block contains  $N$  frames. The acquisition length for a block is calculated using this equation:

$$(\text{One block acquisition length}) = N \times (\text{One frame acquisition length})$$

One block acquisition length is set using **Acquisition Length** in the Timing menu. One frame acquisition length is set internally, depending on span, and displayed in **Spectrum Length** in the Timing menu.

To set the acquisition length, perform the following steps:

1. Press the **TIMING** key on the front panel.

By default, Acquisition Length is set to 64 ms and Spectrum Length 32 ms. The number of frames in a block is  $64 \div 32 = 2$ .

2. Press the **Acquisition Length** side key to change the value. For example, set 256 ms by turning the knob (see Figure 2–54).

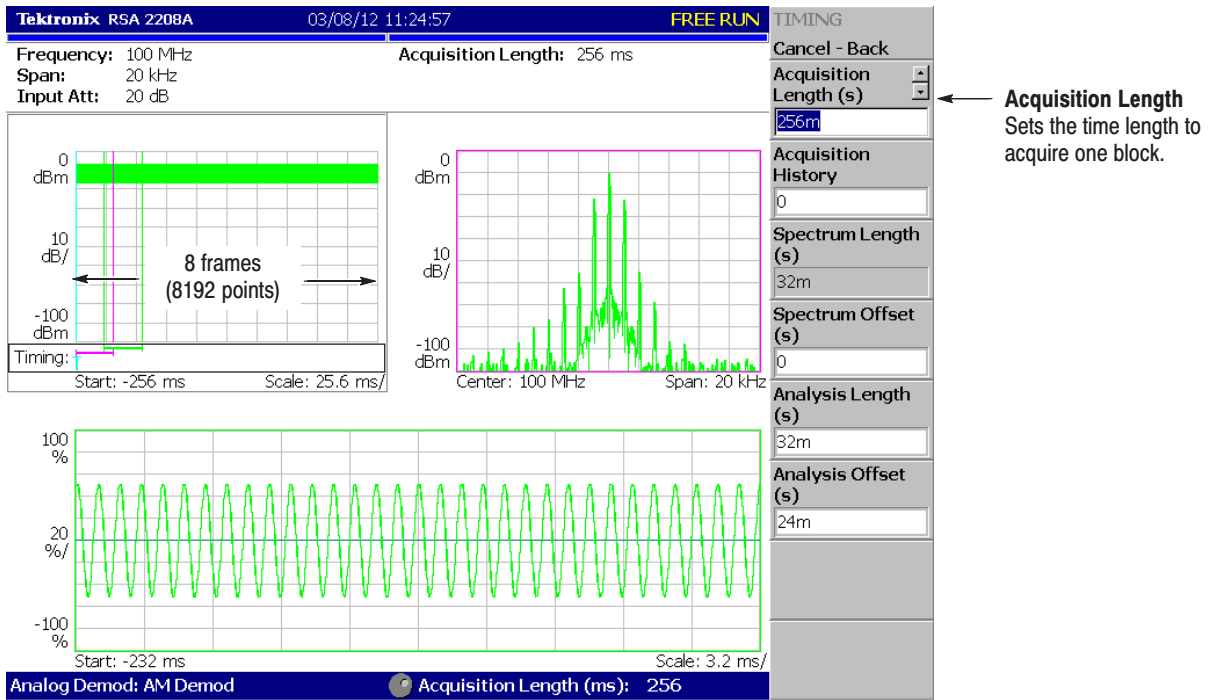


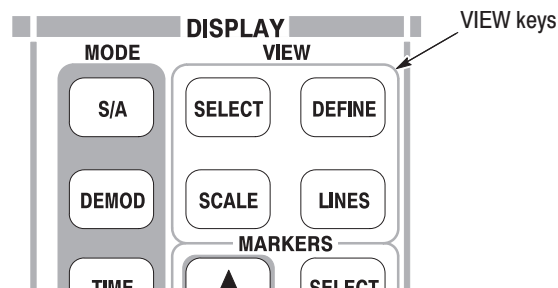
Figure 2-54: Changing the acquisition length

In this case, Acquisition Length is 256 ms and Spectrum Length 32 ms, so the data is displayed in the overview for  $256 \div 32 = 8$  frames (8192 points). The green underline indicating the analysis range gets narrower than the previous setting: one block = 2 frames.

### Displaying Single View and Changing Scale

Although three views are normally displayed in the Demod mode, you can select one view to display full screen. This section describes how to display one view and change the vertical and horizontal scales using the VIEW keys.

1. Press the **RUN/STOP** key to stop data acquisition and observe the waveform.
2. Press the **VIEW: SELECT** key to select the main view. The selected view is surrounded with a white frame.



3. Press the **DEFINE** key, and then the **Show Views** side key, shown in Figure 2–55, to select **Single**.

Only the main view is displayed, with the size enlarged on the screen.

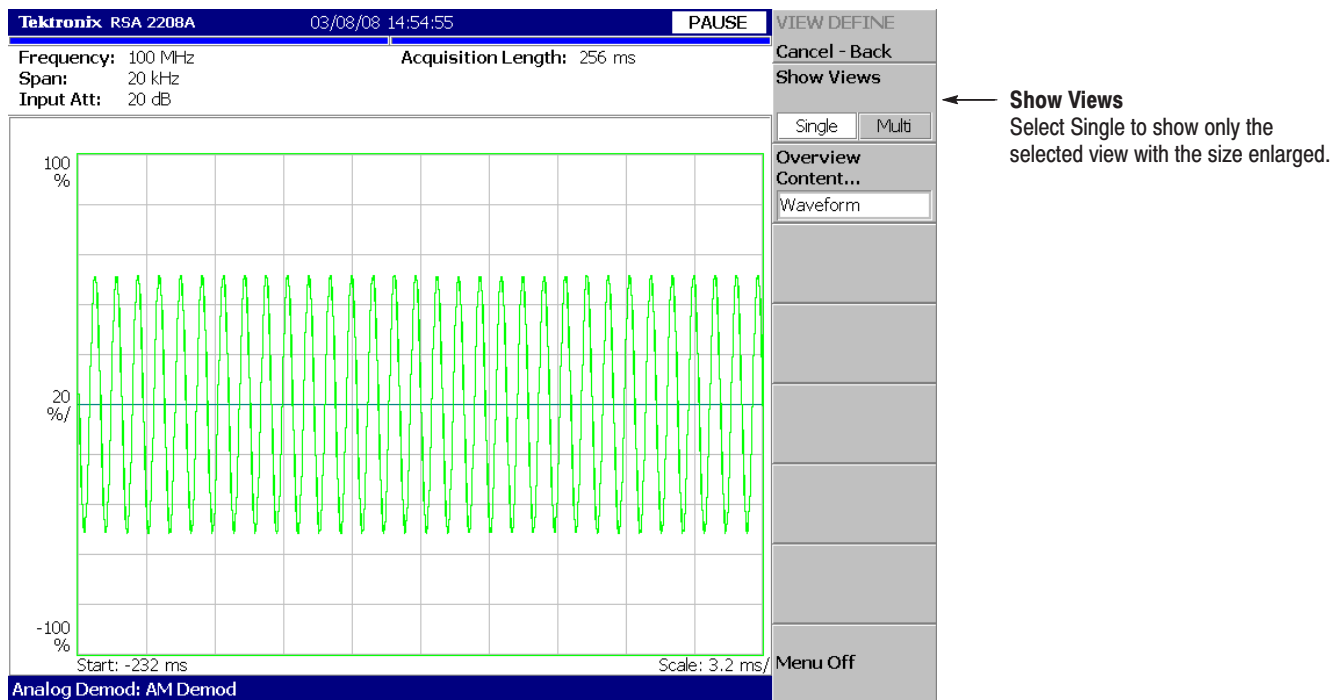
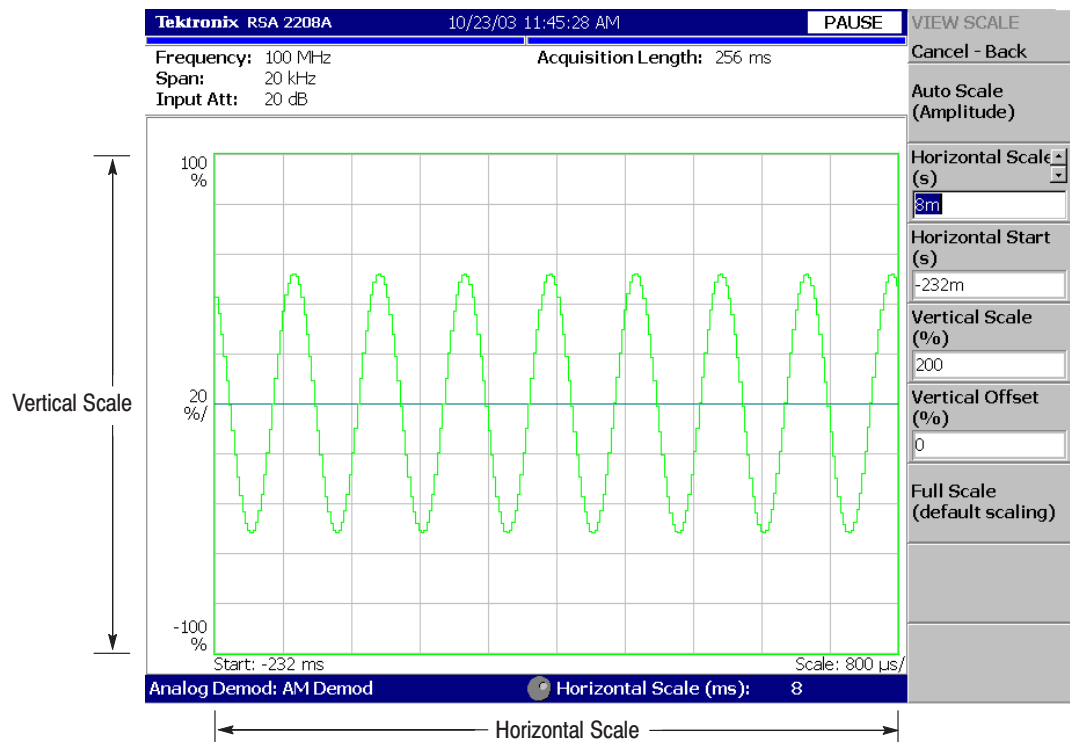


Figure 2–55: Single view display

4. Change the scale:
  - a. Press the **SCALE** key in the VIEW area.
  - b. Press the **Horizontal Scale** side key and change the scale of the horizontal axis (see Figure 2–56). Try several settings by turning the general purpose knob; observe the changes in the display.
  - c. Press the **Vertical Scale** side key and change the vertical axis scale. Try several settings by turning the knob; observe the changes in the display.



**Figure 2–56: Scale settings**

### Completing the Measurement

Complete the measurement with the following procedure:

1. Press the **MEASURE** key on the front panel.
2. Press the **Measurement Off** side key.

The display returns to the spectrum view. However, the analysis mode is still in the Demod mode.

## Turning Off the Power

When you have completed the measurements, turn off the power:

1. Press the **ON/STANDBY** switch at the lower left of the front panel.

The shutdown process of Windows XP runs and the power source goes to standby state, with the orange LED on.

2. Turn off the signal generator.

You have now completed the tutorial.

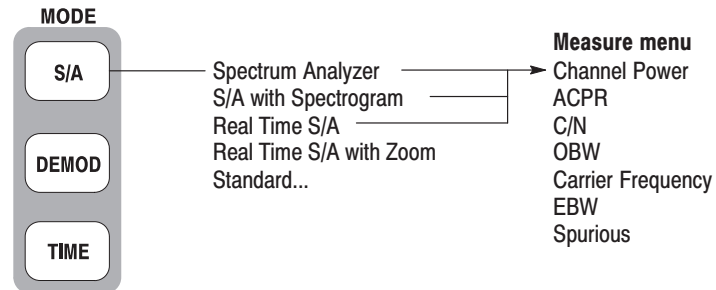
# Reference





# Spectrum Analysis (S/A Mode)

This section describes how to perform measurements in the spectrum analysis (S/A) mode.



**Figure 3-1: S/A menu structure**

There are four items in the S/A menu:

- **Spectrum Analyzer.** Performs general spectrum analysis. Refer to page 3-4 for details.
- **S/A with Spectrogram.** Performs spectrum analysis with spectrogram. Refer to page 3-18 for details.
- **Real Time S/A.** Performs real-time spectrum analysis with spectrogram. Refer to page 3-20 for details.
- **Real Time S/A with Zoom.** Performs real-time spectrum analysis with zoom function. Refer to page 3-24 for details.
- **Standard....** Performs spectrum analysis according to a communication standard. No function is included currently.

## Measurement Screen Layout

Figure 3–2 shows the basic screen layout in the spectrum analysis (S/A mode). The spectrum waveform and measurement results are displayed. You can display the spectrum and the spectrogram at the same time. Refer to *Spectrogram Display* on page 3–18.

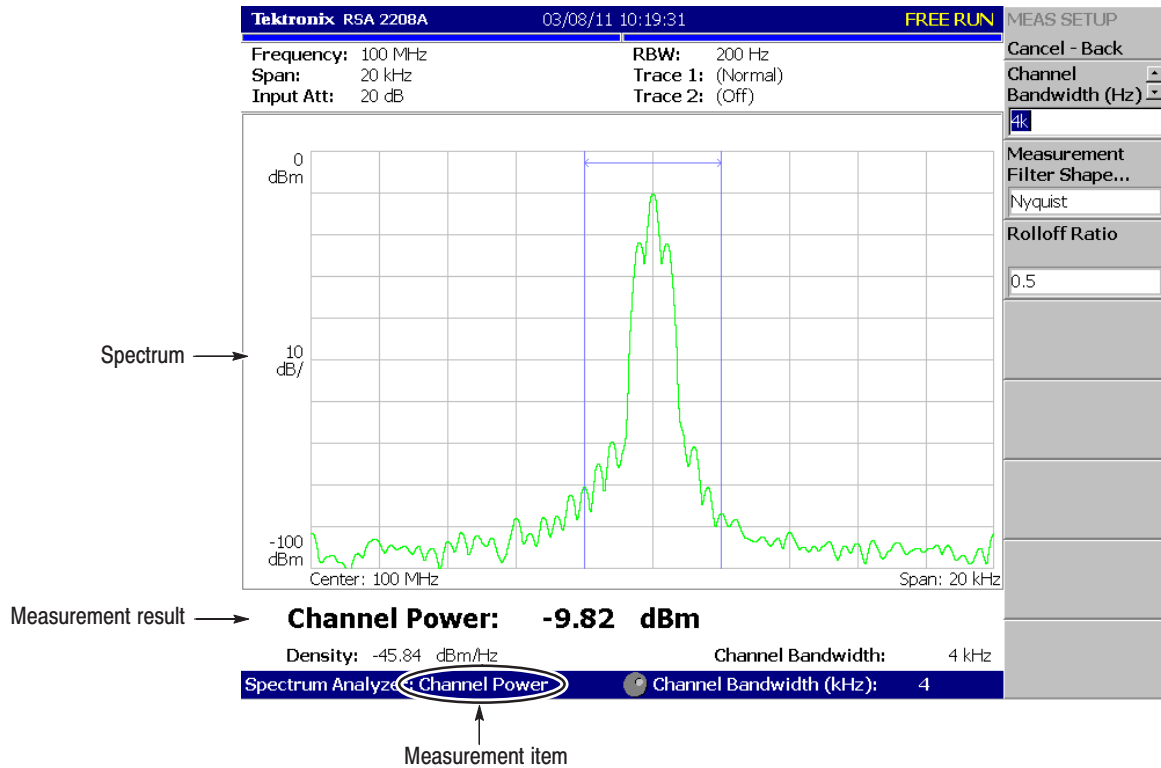


Figure 3–2: S/A measurement screen

## Changing the Grid Style

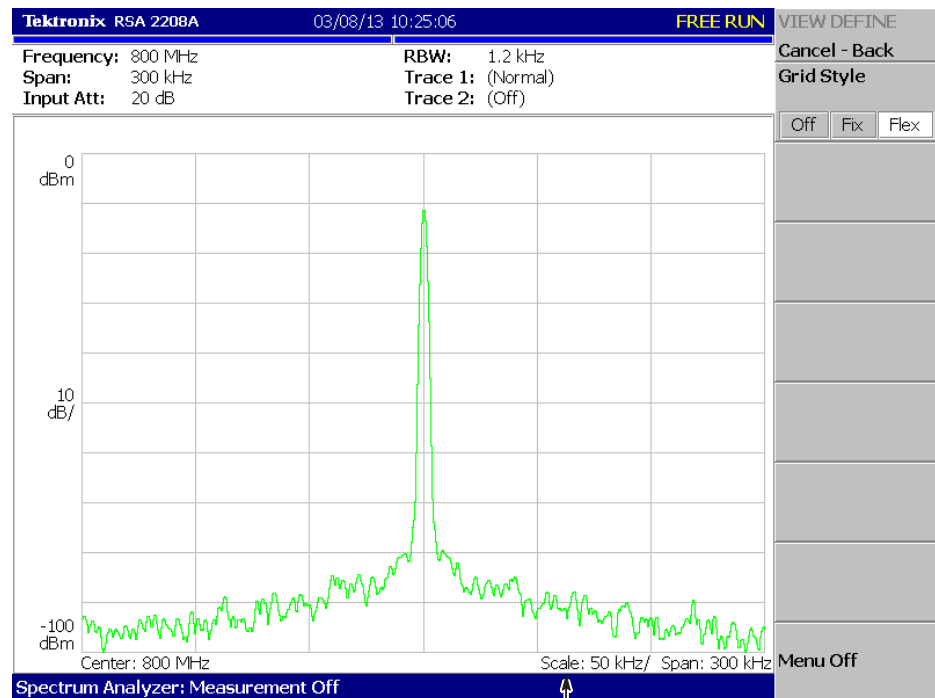
The graticule is a  $10 \times 10$  grid by default. You can select a different grid style by pressing VIEW: **DEFINE** → **Grid Style** as follows:

**NOTE.** The Grid Style menu item is available only in the S/A mode except Real Time S/A.

**Off.** Turns off the graticule.

**Fix.** Always displays a  $10 \times 10$  grid.

**Flex.** Displays the graticule with the horizontal scale (per division) in a 1-2-5 sequence.



The horizontal scale is set to 50 kHz/div for span of 300 kHz in the "Flex" grid style.

**Figure 3-3: "Flex" grid style**

## Spectrum Analysis

You can select following measurement items with the **MEASURE** key when you select **S/A** and then the **Spectrum Analyzer** side key.

**Table 3-1: Measurement items in the S/A mode**

Measure menu	Title	Refer to:
Channel Power	Channel Power Measurement	page 3-5
ACPR	ACPR (Adjacent Channel Power Ratio) Measurement	page 3-7
C/N	C/N (Carrier to Noise ratio) Measurement	page 3-9
OBW	OBW (Occupied Band Width) Measurement	page 3-11
Carrier Frequency	Carrier Frequency Measurement	page 3-13
EBW	EBW (Emission Band Width) Measurement	page 3-14
Spurious	Spurious Signal Measurement	page 3-16

Pressing the **Measurement Off** side key stops the measurement and returns to the original spectral display.

### Basic Procedure

1. Press the **S/A** key and then the **Spectrum Analyzer** side key.
2. Select the measurement item (refer to Table 3-1).
3. Display the spectrum waveform of the measurement signal:
  - a. Press the **RUN/STOP** key on the front panel to start data acquisition.

---

**NOTE.** For details on setting frequency, span, and amplitude, refer to Setting Frequency and Span on page 3-63 and Setting Amplitude on page 3-71.

---

- b. Set the frequency by pressing the **FREQUENCY/CHANNEL** key on the front panel.
  - c. Set the span by pressing the **SPAN** key on the front panel.
  - d. Set the amplitude by pressing the **AMPLITUDE** key on the front panel.
4. Set the following Measurement Setup controls by pressing the **MEAS SETUP** key on the front panel.

**Channel Power Measurement**

This measurement calculates power in the range specified using a band power marker (shown in Figure 3–4).

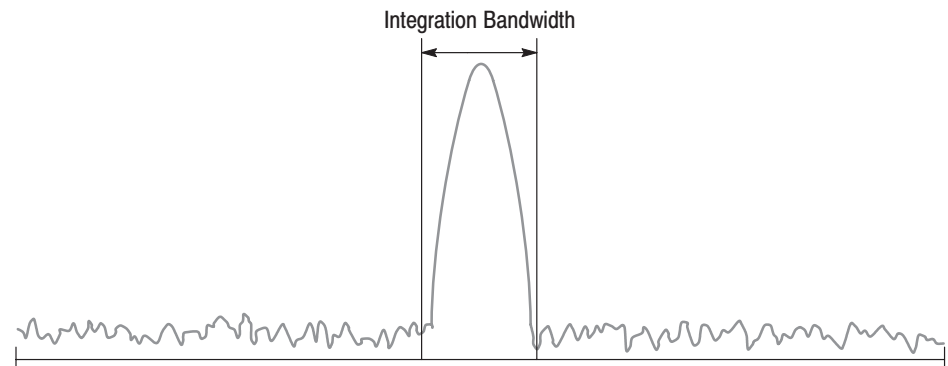
**Meas Setup Menu.** The Meas Setup menu for the channel power measurement contains the following controls:

**Integration Bandwidth.** Sets frequency range for power measurement (see Figure 3–4).

**Measurement Filter Shape...** Selects a filter shape from these types:

- Rect (Rectangular)
- Gaussian
- Nyquist
- Root Nyquist

**Rolloff Ratio.** Enters rolloff ratio when Nyquist or Root Nyquist filter is selected. Range: 0.0001 to 1 (default value: 0.5).



**Figure 3–4: Channel power measurement band power markers**

An example of the channel power measurement is shown in Figure 3-5.

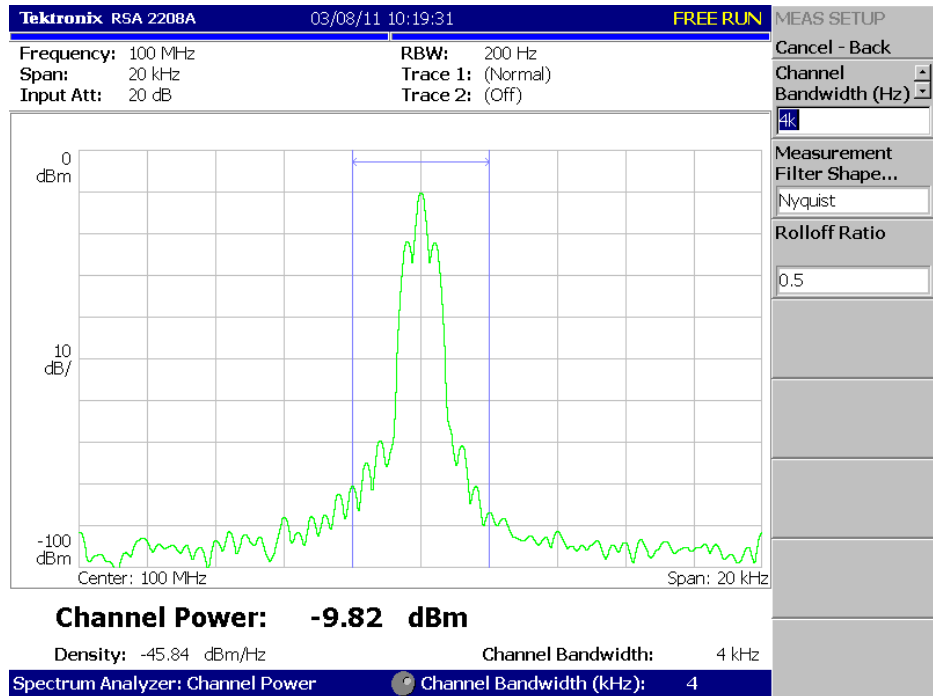


Figure 3-5: Channel power measurement

**ACPR Measurement**

The power ratio of the carrier signal to the signal appearing in its adjacent frequency band (leak signal) is measured in the ACPR (Adjacent Channel Power Ratio) measurement. Frequency ranges are set using three band power markers.

**Meas Setup Menu.** The Meas Setup menu for the ACPR measurement contains the following controls (see Figure 3–6):

**Main Channel Bandwidth.** Sets frequency range of main channel.

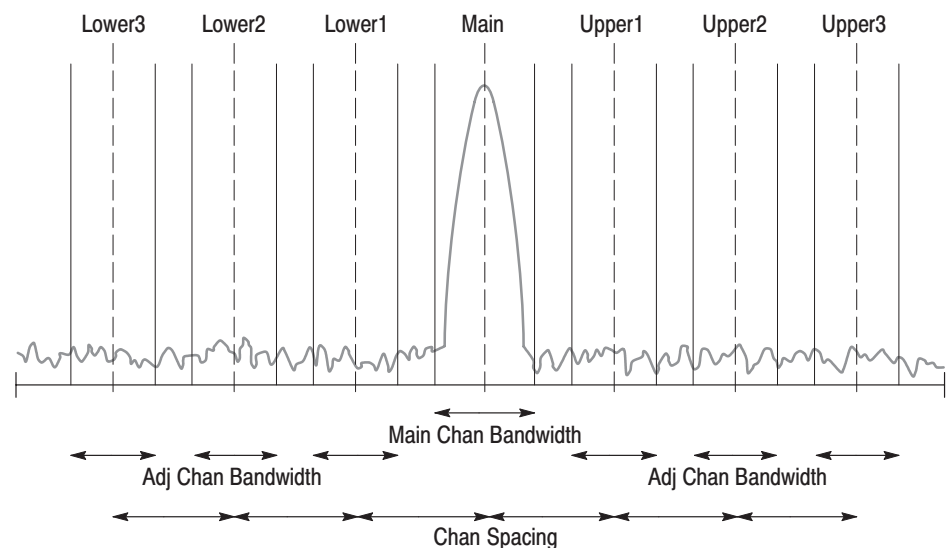
**Adjacent Channel Bandwidth.** Sets frequency range of adjacent channel.

**Chan Spacing.** Sets a frequency interval between two adjacent channels.

**Measurement Filter Shape...** Selects a filter shape from these types:

- Rect (Rectangular)
- Gaussian
- Nyquist
- Root Nyquist

**Rolloff Ratio.** Enters rolloff ratio when Nyquist or Root Nyquist filter is selected. Range: 0.0001 to 1 (default value: 0.5).



**Figure 3–6: ACPR measurement band power markers**

Figure 3–7 shows an example of the ACPR measurement.

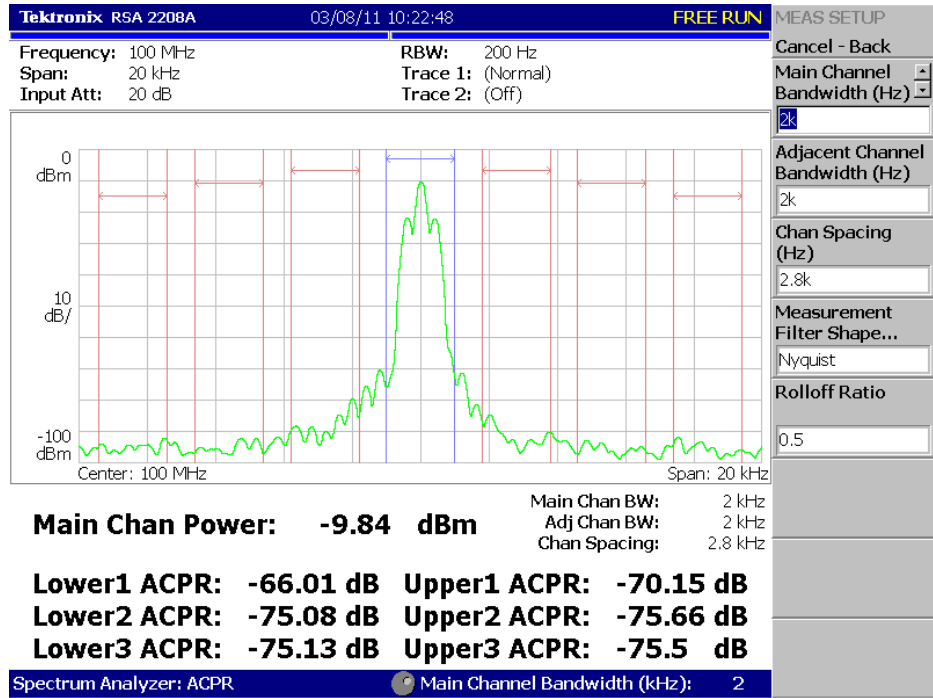


Figure 3–7: Example of ACPR measurement



**C/N Measuremen** Measures Carrier to Noise ratio (C/N).

**Meas Setup Menu.** The Meas Setup menu for the C/N measurement contains the following controls (see Figure 3–8).

**Offset Frequency.** Sets the offset frequency from carrier to noise.  
Range:  $-\text{Span}/2$  to  $+\text{Span}/2$ .

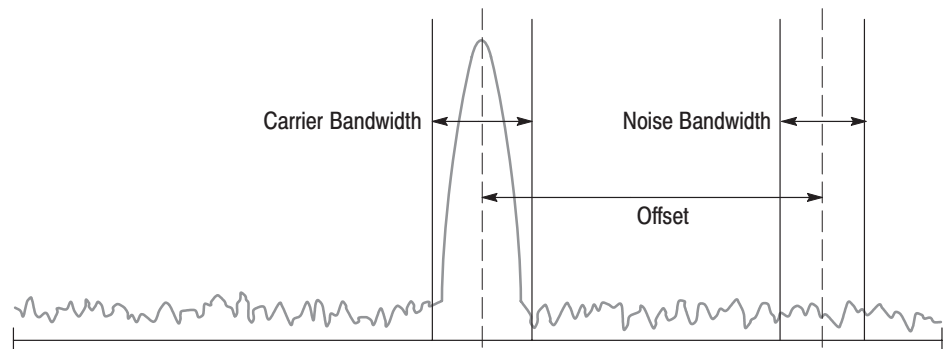
**Noise Bandwidth.** Sets the noise bandwidth.

**Carrier Bandwidth.** Sets the carrier bandwidth.

**Measurement Filter Shape...** Selects a filter shape from these types:

- Rect (Rectangular)
- Gaussian
- Nyquist
- Root Nyquist

**Rolloff Ratio.** Enters rolloff ratio when Nyquist or Root Nyquist filter is selected. Range: 0.0001 to 1 (default value: 0.5).



**Figure 3–8: C/N measurement band power markers**

Figure 3–9 shows an example of the C/N measurement.

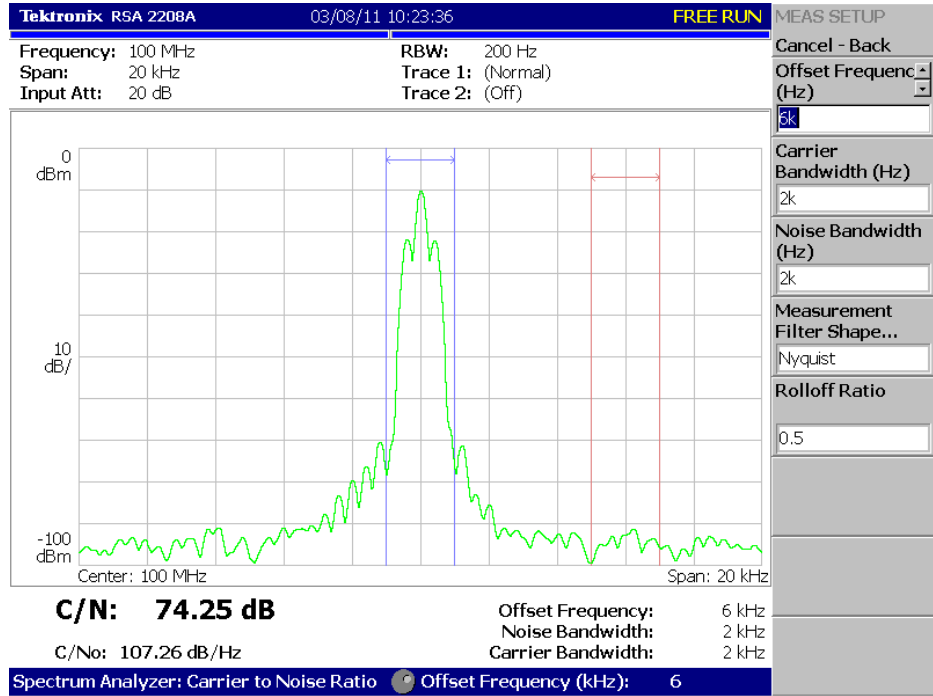


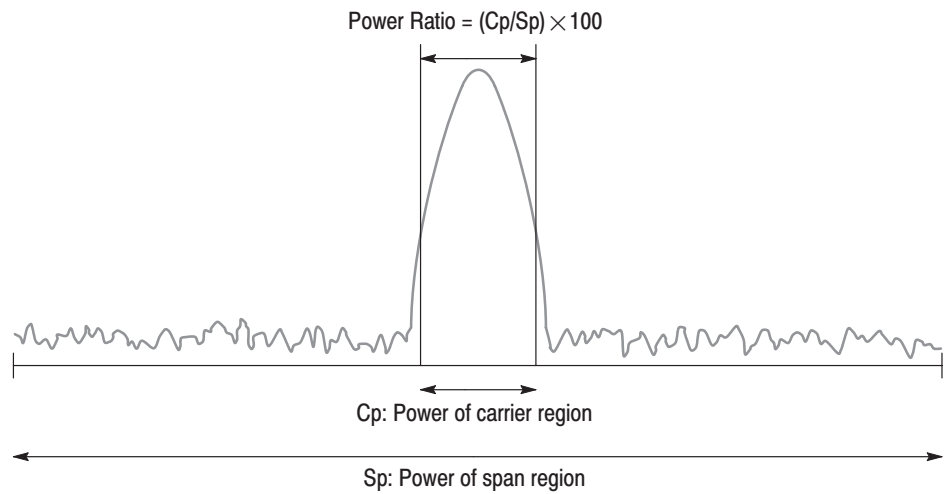
Figure 3–9: Example of C/N measurement

**OBW Measurement**

The OBW (Occupied Bandwidth) measures the frequency bandwidth, using the ratio you specify for carrier signal power / power within the span setting.

**Meas Setup Menu.** The Meas Setup menu for the OBW measurement contains the following control.

**Power Ratio.** Specifies the power ratio of the carrier and span regions for calculating OBW (see Figure 3–10). The default setting is 99% as defined in T–53 or IS–95 standard. Range: 80 to 99.99%.



**Figure 3–10: OBW measurement band power marker**

Figure 3–11 shows an example of the OBW measurement.

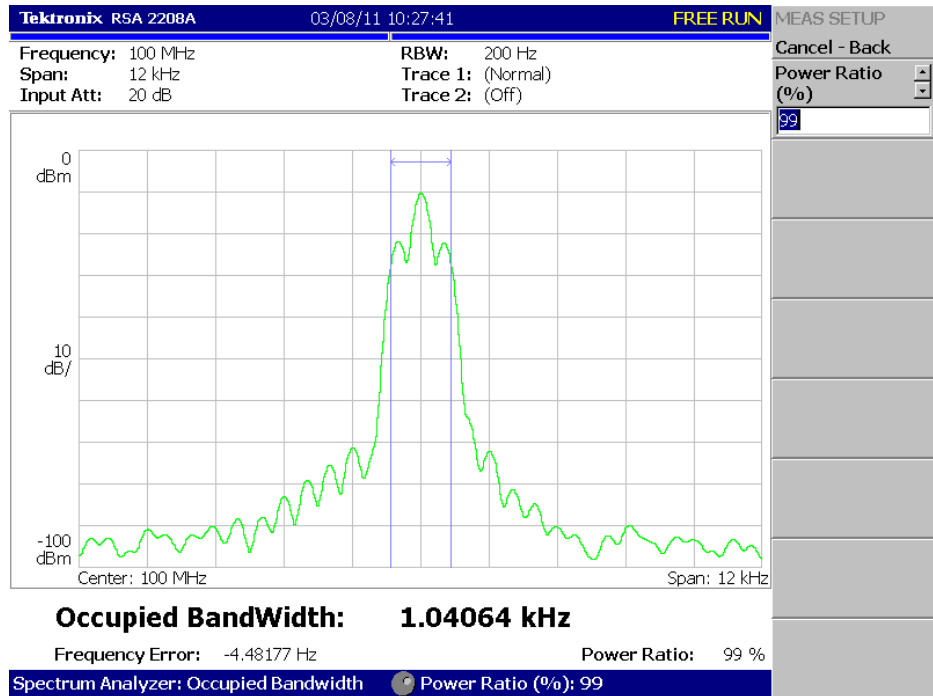


Figure 3–11: Example of OBW measurement

## Carrier Frequency Measurement

Carrier frequency is accurately measured using the counter function.

**NOTE.** You must set the frequency and the span to display only the spectrum with the carrier you want to measure. Measurement error will occur if other frequency components are displayed together.

**Meas Setup Menu.** The Meas Setup menu for the Carrier Frequency measurement contains the following control:

**Counter Resolution.** Sets the counter resolution. The measurement result is displayed on the bottom of the view with this resolution.

Range: 1 mHz to 1 MHz in a tenfold sequence (default: 1 Hz).

Figure 3–12 shows an example of the carrier frequency measurement.

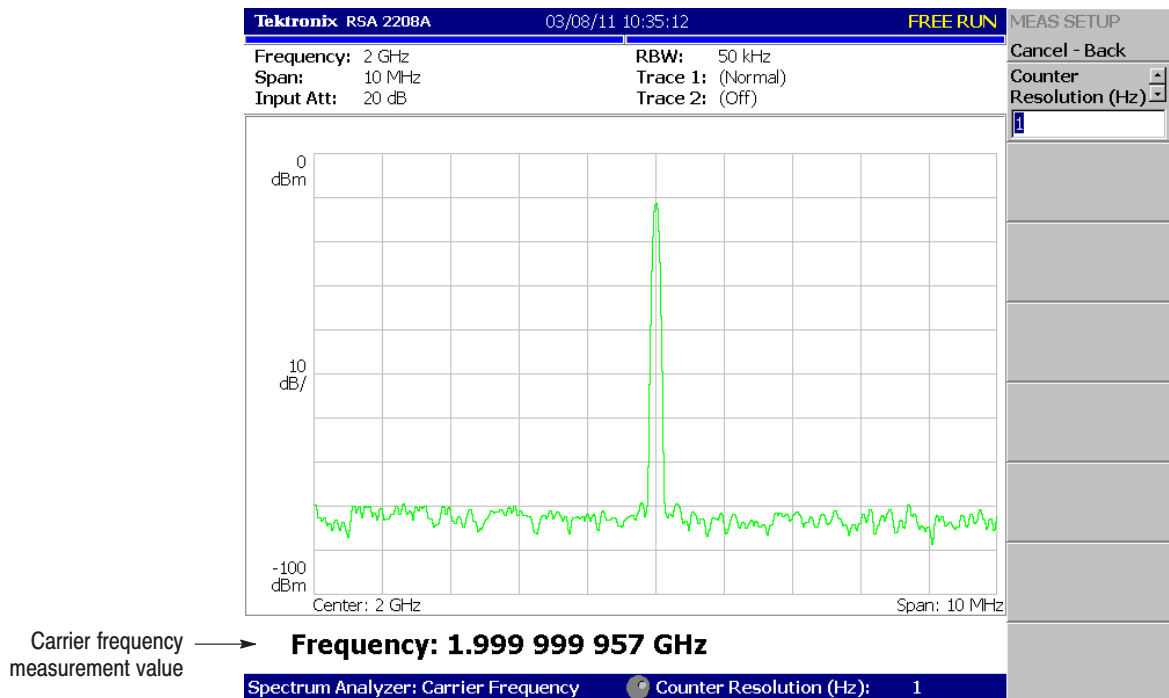


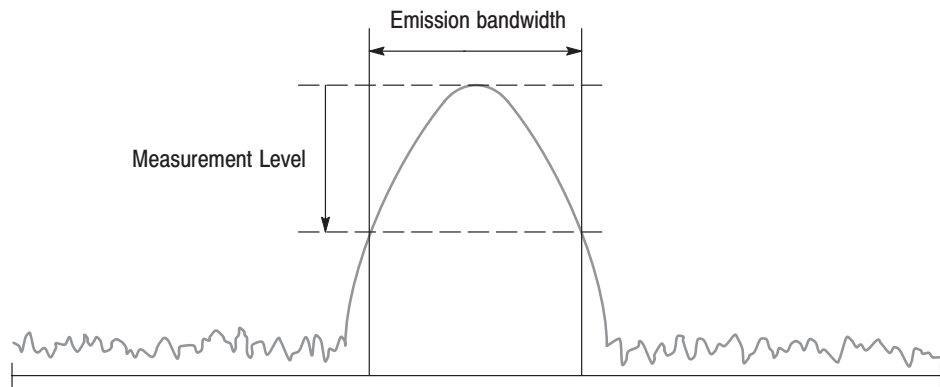
Figure 3–12: Carrier frequency measurement

**EBW Measurement**

The frequency bandwidth between the maximum peak of the spectrum and the specified dB value is measured in EBW (Emission Bandwidth).

**Meas Setup Menu.** The Meas Setup menu for the EBW measurement contains the following control:

**Measurement Level.** Specifies how far down from the peak level the bandwidth is measured (see Figure 3-13). Range: -100 to -1 dB (default: -30 dB).



**Figure 3-13: EBW measurement band power markers**

Figure 3–14 shows an example of the EBW measurement.

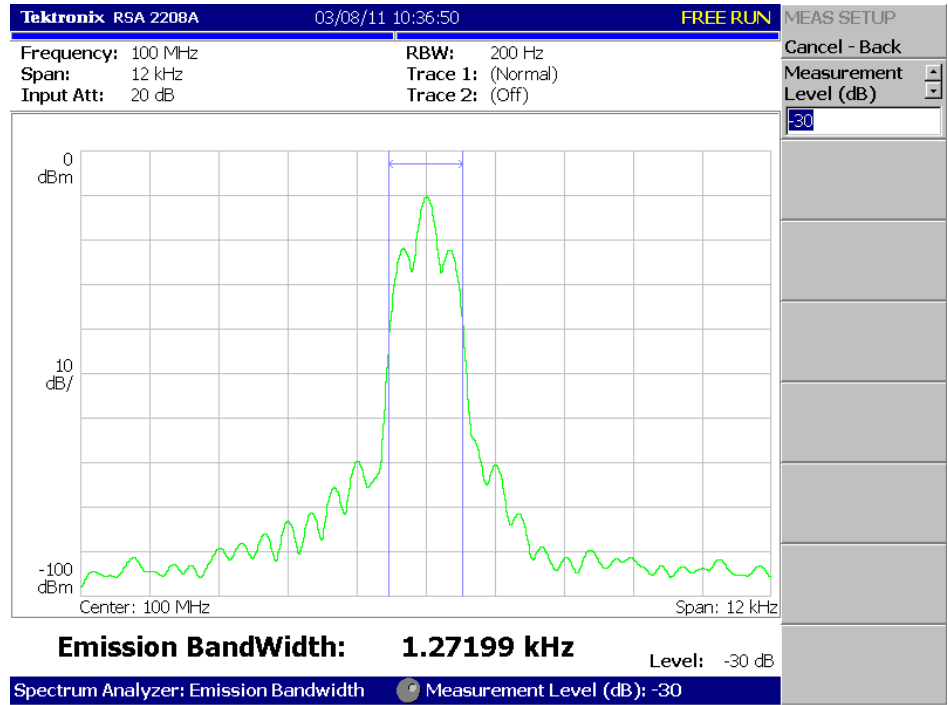


Figure 3–14: EBW measurement

## Spurious Signal Measurement

The spurious signal measurement detects up to 20 spurious signals and calculates the frequency difference and the amplitude ratio relative to the normal signal by setting the level conditions.

---

**NOTE.** For detecting stationary spurious signals, waveform averaging is effective for reducing noise. Refer to page 3–113 for averaging.

---

**Meas Setup Menu.** The Meas Setup menu for the spurious signal measurement contains the following controls:

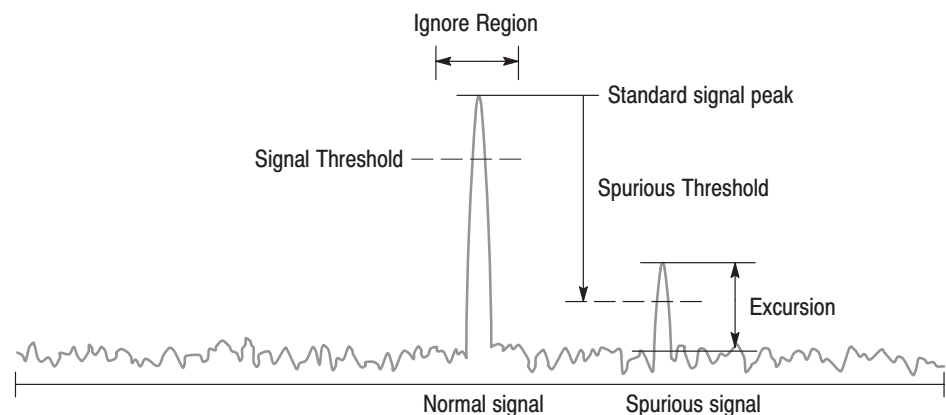
**Signal Threshold.** Sets the threshold for detecting the standard signal (see Figure 3–15). A signal whose amplitude is larger than this threshold is regarded as a standard signal. Range: –100 to +30 dBm.

**Ignore Region.** Sets the frequency range with the carrier (standard signal) peak as the center in which spurious signals are not to be detected, for avoiding false recognition of spurious signals (see Figure 3–15). Range: 0 to Span/2 Hz (default: 0 Hz)

**Spurious Threshold.** Sets the threshold for detecting spurious signals (see Figure 3–15). Enter the value relative to the peak of standard signal. Range: –90 to –30 dB.

**Excursion.** Sets the deviation amount of amplitude that is considered to be spurious (see Figure 3–15). A signal with amplitude higher than the set value of the Spurious Threshold and larger than the set value of Excursion is considered to be spurious. Range: 0 to 30 dB (default: 3 dB)

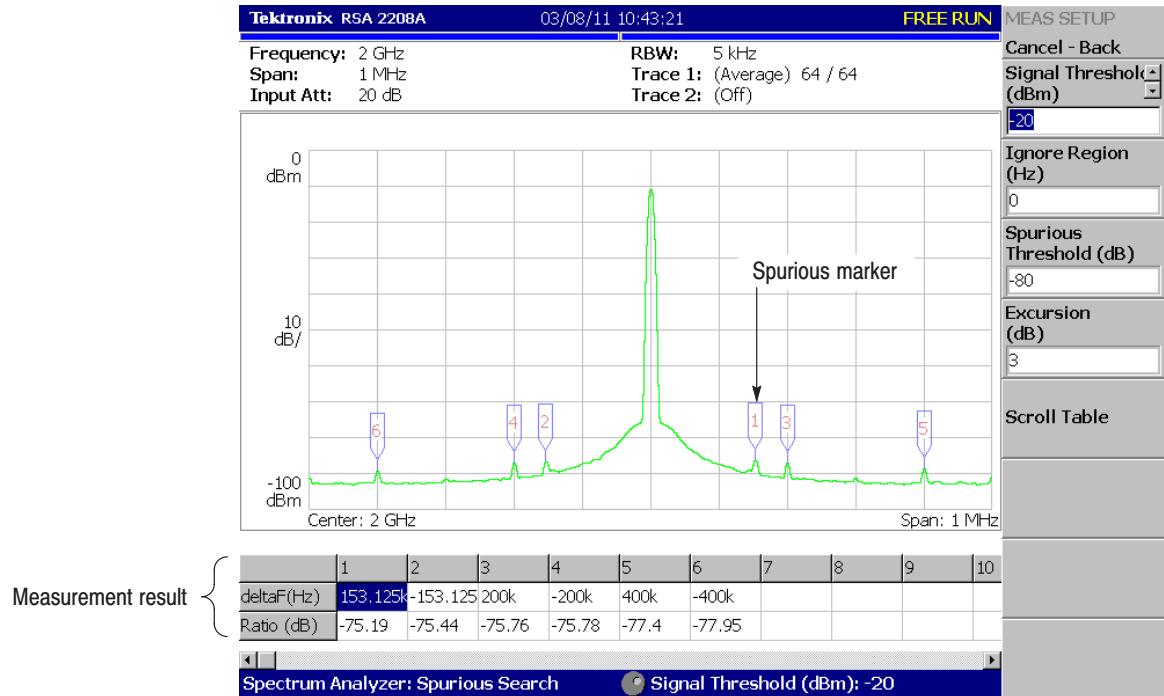
**Scroll Table.** Horizontally scrolls the spurious table displayed in the lower part of the screen. Up to 20 spurious signals are displayed.



**Figure 3–15: Setting up spurious signal measurement**



Figure 3–16 shows an example of spurious signal measurement.



**Figure 3–16: Example of spurious signal measurement**

Detected spurious signals are assigned markers, numbered in descending order by amplitude. The frequency difference (deltaF) and the amplitude ratio (Ratio) in relation to the standard signal are shown in the table in the lower part of the screen.

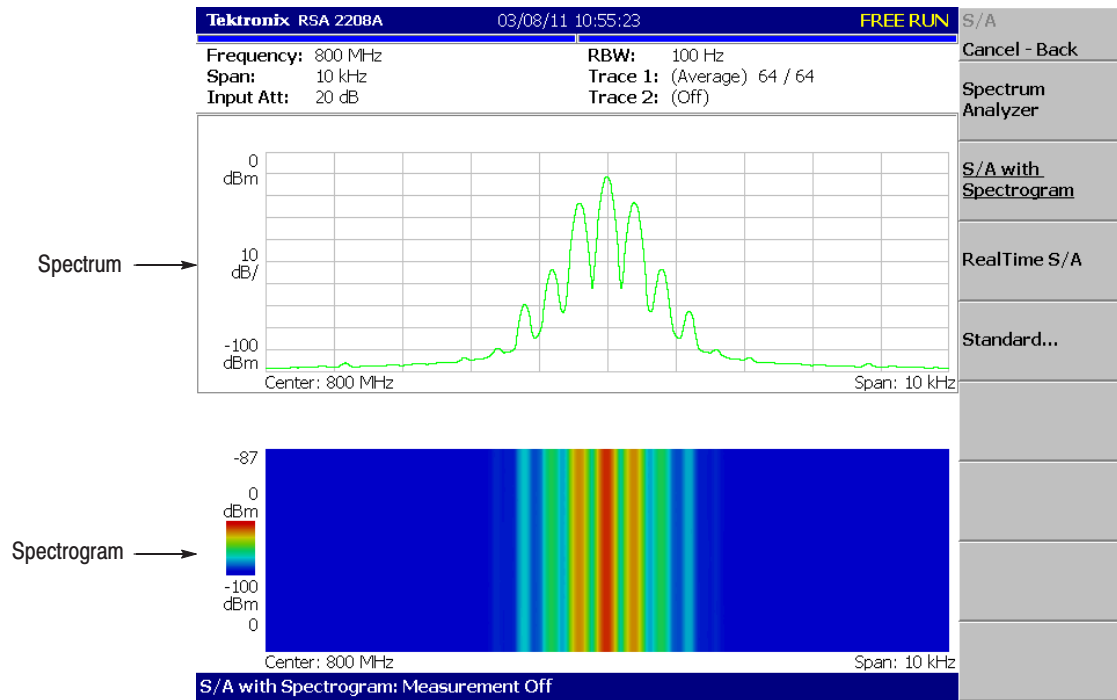
## Spectrogram Display

You can display the spectrum of an input signal concurrently with the spectrogram.

Follow these steps to display the spectrogram:

1. Press the **S/A** key on the front panel.
2. Press the **S/A with Spectrogram** side key.

The spectrum and spectrogram are displayed on the same screen as shown in Figure 3–17.

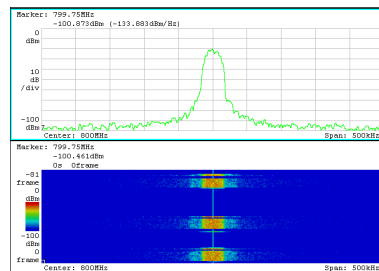


**Figure 3–17: Spectrum and spectrogram concurrent display**

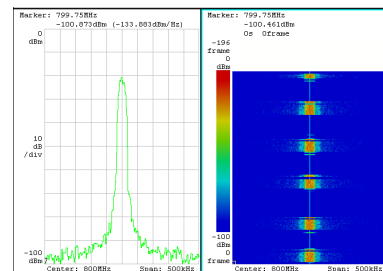
## Changing Display Style

You can change display style as required.

1. Press the **VIEW: DEFINE** key.
2. Press the **View Orientation** side key to select the view style: **Wide** or **Tall**.



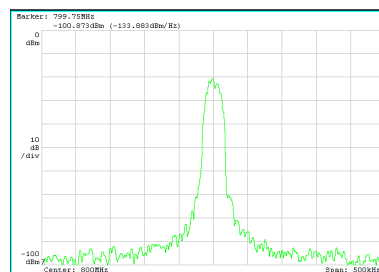
**Wide display**  
Displays spectrum and spectrogram  
in line-split display.



**Tall display**  
Display spectrum and spectrogram  
side by side.

**Figure 3-18: View orientation**

3. When you display either spectrum or spectrogram only on full-screen, press the **VIEW: SELECT** key to select the view. The selected view is surrounded by a light-blue frame.
4. Press the **Show Views** side key and select **Single** as shown in Figure 3-19.



**Single display**  
Displays the selected view on one screen.

**Figure 3-19: Single display**

Refer to *Setting Views* on page 3-123 for details.

## Real-Time Analysis

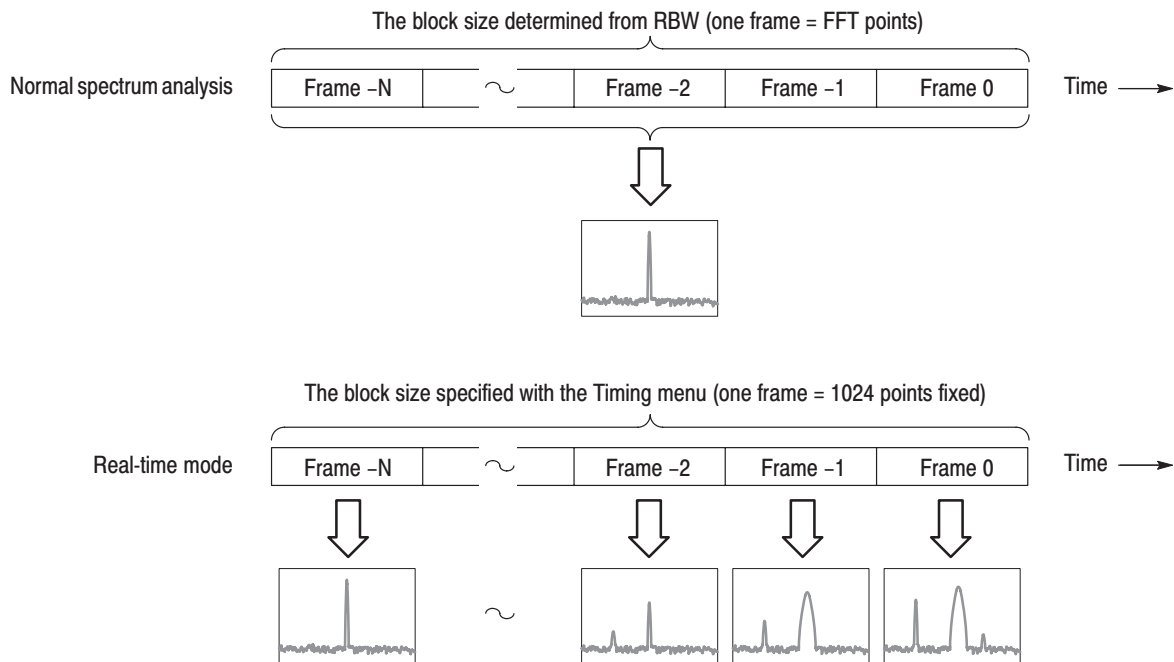
When you select **S/A** → **Real Time S/A**, the analyzer performs the real-time analysis, displaying the spectrogram. The screen layout is the same as that when you select **S/A** → **S/A with Spectrogram**. Refer to *Spectrogram Display* on page 3–18.

**NOTE.** The TRACE/AVG menu is not available in the real-time mode.

The Real-Time S/A mode has FFT overlap capability. Refer to FFT and RBW on page 3–103 for detail.

### Features of the Real-Time Mode

An input waveform is acquired in blocks, where a block is defined as a number of frames and a frame is defined as a number of FFT data points. The number of frames acquired at one time is called block size. In the normal spectrum analysis, the instrument acquires data for the block size determined from RBW and creates one spectrum waveform. In the real-time mode, the instrument acquires data for the block size specified with the Timing menu, performs the FFT process, and creates spectrum waveforms for each frame so that you can observe spectrum variation in time seamlessly. The difference between normal and real-time modes is shown in Figure 3–20.



**Figure 3–20: Difference between normal and real-time modes**

Table 3–2 shows the features of the real-time mode compared with the normal spectrum analysis.

**Table 3–2: Features of the real-time mode**

Item	Normal spectrum analysis	Real-time mode
Span	Up to 3 GHz (arbitrary value can be set)	Up to 10 MHz (1-2-5 sequence)
Trigger	Only the Repeat menu item available	All the Trigger menu items available
RBW/FFT	FFT points: 64 to 8192 (powers of 2) RBW: 1 Hz to 10 MHz	FFT points: 1024 fixed RBW: No RBW process FFT overlap capability
Timing	No timing parameters	Acquisition Length and Spectrum Offset can be set

### Basic Procedure

The following steps show the basic procedure for real-time spectrum analysis with spectrogram:

1. Press the **S/A** key on the front panel.
2. Press the **Real Time S/A** side key. The spectrum is displayed concurrently with the spectrogram.
3. Display the spectrum waveform of the measurement signal:

---

**NOTE.** For details on setting frequency, span, and amplitude, refer to Setting Frequency and Span on page 3–63 and Setting Amplitude on page 3–71.

For details on setting trigger, refer to Trigger on page 3–91.

---

- a. Set the frequency by pressing the **FREQUENCY/CHANNEL** key on the front panel.
- b. Set the span by pressing the **SPAN** key on the front panel.  
Table 3–3 shows the span setting range.
- c. Set the amplitude by pressing the **AMPLITUDE** key on the front panel.
- d. Set the trigger by pressing the **TRIG** key on the front panel.

**Table 3–3: Span setting range**

Measurement band	Setting range
RF (10 MHz to 3 GHz (RSA2203A)/ 8 GHz (RSA2208A))	100 Hz to 10 MHz (1-2-5 sequence)
Baseband (DC to 20 MHz, Option 05)	100 Hz to 20 MHz (1-2-5 sequence)

4. Press the **TIMING** key on the front panel and then the **Acquisition Length** side key to set the time length to acquire one block.

Suppose that one block contains N frames; the acquisition length is calculated with this equation:

$$(\text{One block acquisition length}) = N \times (\text{One frame acquisition length})$$

Where N = 1 to 500

One frame acquisition length is determined by span internally, and shown with Spectrum Length in the setup display area (see Figure 3–21). For the details, refer to Table A–10 on page A–8 in *Appendix A: Specifications*.

Waveform data is acquired and displayed on the basis of blocks. For details about the time parameters, refer to page 3–85.

5. When you have acquired the measurement data, stop the data acquisition. If the analyzer is in the continuous acquisition mode, press **RUN/STOP**.
6. Press the **Spectrum Offset** side key and set the number of the frame to measure and display in the spectrum view (upper view) by turning the general purpose knob or using the numeric keypad.

Serial numbers are given to each frame regardless of the block size, with zero representing the latest frame. The selected frame is indicated by the marker on the spectrogram (see Figure 3–21).

Alternatively, the frame number can be set as follows:

- a. Press the VIEW: **SELECT** key to select the spectrogram view.
- b. Press the **MARKER SETUP** key.
- c. Press the **Go to page 2** → **Marker X Vertical** side key.
- d. Set the frame number by turning the general purpose knob or using the numeric keypad.

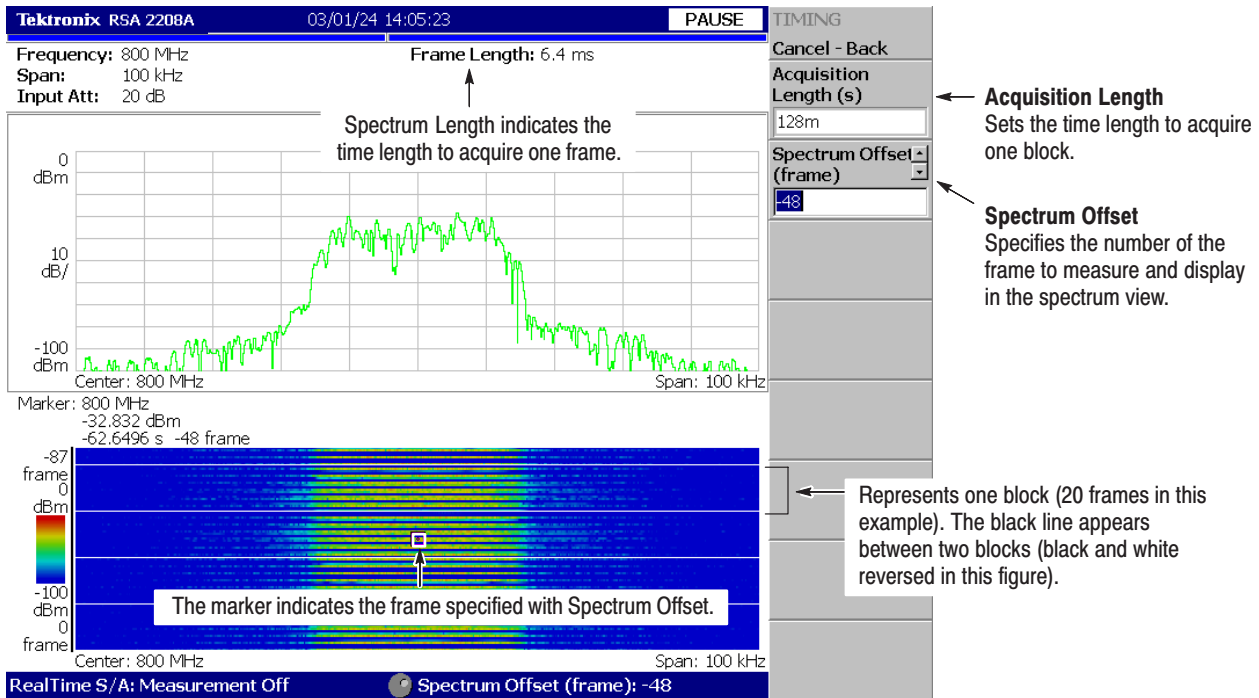


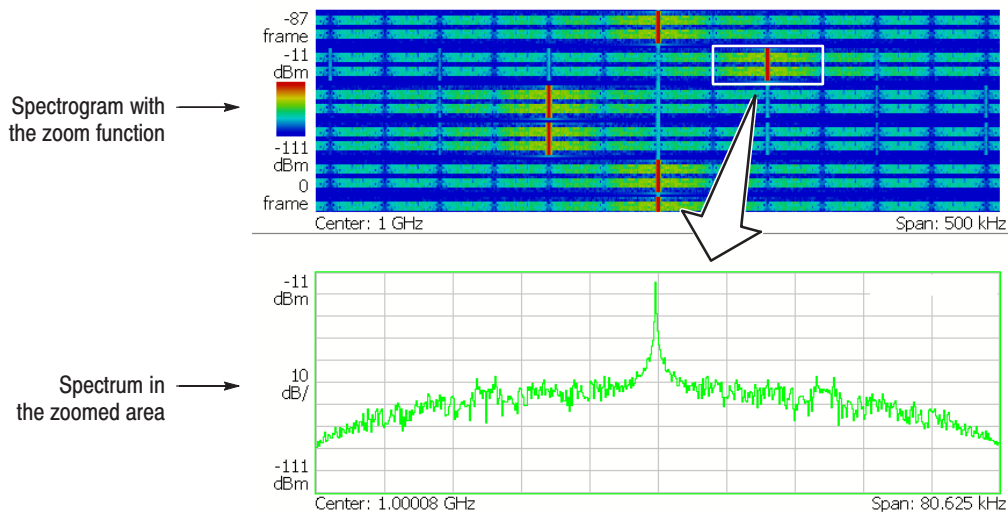
Figure 3-21: Real-time mode

7. To take a spectrum measurement, press the **MEASURE** key on the front panel. The measurement items and procedures are the same as in the normal spectrum analysis. Refer to *Spectrum Analysis* on page 3-4.
8. To change the display format, press the **DEFINE** key on the front panel. The setting procedure is the same as in the normal spectrum analysis. Refer to *Spectrogram Display* on page 3-18.

**NOTE.** In real-time mode, you cannot turn on or off the spectrogram in the View: Define menu.

## Zoom Function

When you select **S/A** → **Real Time S/A with Zoom**, the real-time analysis area can be specified on the spectrogram. Even though frequency hopping occurs, measurement can only be made by clipping the optional burst (see Figure 3–22).



**Figure 3–22: Zoom function**

### Timing Menu

In the spectrogram with the zoom function display, the zoomed area is set by the following Timing menu (see Figure 3–23). The area is the analysis range.

**Acquisition Length.** Sets the capture time of one block.

**Acquisition History.** A block number that analyzes/displays data is specified. The latest block number is 0. Older blocks have larger negative numbers.

**Analysis Length.** Sets the time length of the zoomed area in the block set in the Acquisition History.

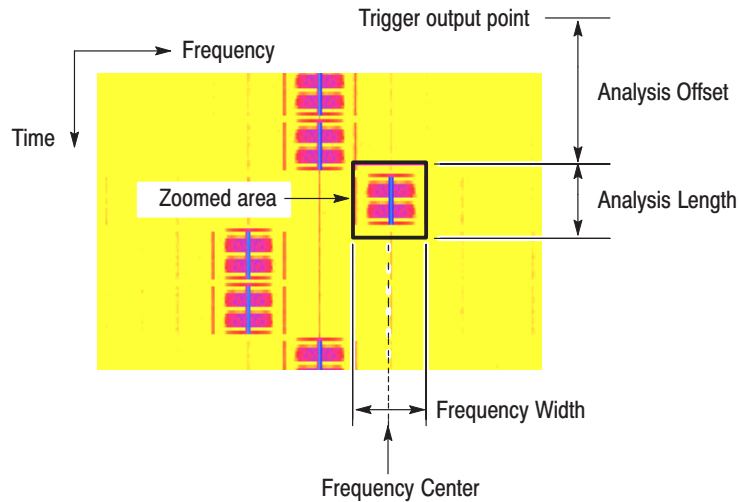
**Analysis Offset.** Sets the starting point of the zoomed area by considering the trigger output point as the reference.

**Frequency Center.** Sets the frequency of the center of zoomed area.

**Frequency Width.** Sets the frequency width of the zoomed area.

Refer to *Setting Timing Parameters* on page 3–85.





**Figure 3-23: Zoom domain settings using the Timing menu**

### Setting a Zoomed Area Using the Marker

The zoomed area can be set by using the marker and reference cursor instead of entering a numeric value in the Timing menu (see Figure 3-24). The mouse can also be used in the marker operation (refer to *USB connectors* on page 2-5 for connecting the mouse). In the following procedure, [Mouse] indicates an operation where the mouse is used.

1. Press the **VIEW: SELECT** key on the front panel and select the spectrogram with zoom function.

[Mouse] Click on the spectrogram to select it and then go to step 4.

2. Press the **MARKER SETUP** key on the front panel.
3. Press the **Markers** side key and select **Single** to display the marker.

4. Move the marker to the upper left point of the zoomed area using the **Marker X Position** and the **Marker X Vertical** side keys.

[Mouse] Move the mouse pointer to the upper left point of the zoomed area and left-click to put the marker on it.

5. Press the **Reference Cursor to the Marker X** side key to display the reference cursor on the marker position.

[Mouse] Right-click to display the reference cursor.

6. Move the marker to the lower right point of the zoomed area using the **Marker X Position** and **Marker X Vertical** side keys.

[Mouse] Move the mouse pointer to the lower right point of the zoomed area and left-click to put the marker on it.

7. Press the **MARKER** ➡ key on the front panel, and then press the **Analysis Time = Marker Time** side key.

The zoomed area is enclosed in a green frame.

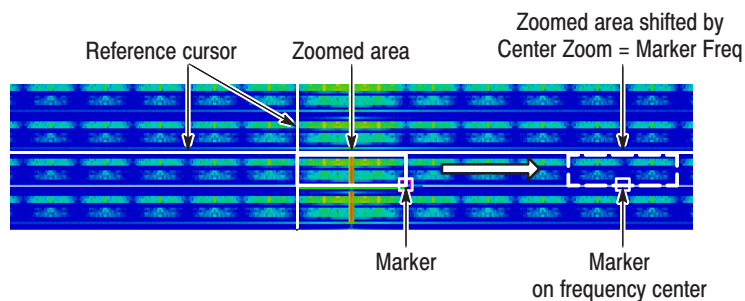
8. When you shift the zoomed area to the left or right on the frequency axis, perform these steps:

- a. Select **MARKER SETUP** → **Marker X Position** and set the new frequency center to put the marker on it.

[Mouse] Move the mouse pointer to the new frequency center and then left-click to put the marker on it.

- b. Select **MARKER** ➡ → **Center Zoom = Marker Freq.**

The zoomed area shifts to the specified frequency.



**Figure 3-24: Zoomed area settings using the marker**

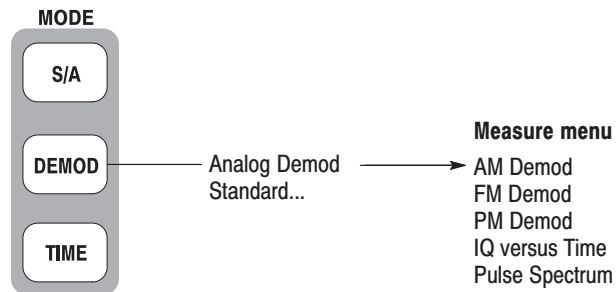
---

**NOTE.** The zoomed spectrum is calculated based on time domain data acquired with a higher sampling rate than for obtaining a normal spectrum. So, a large zoom ratio may cause the skirt shape of the spectrum to differ from that of the spectrum without zoom. However, it does not affect carrier power measurement results.

---

# Modulation Analysis (Demod Mode)

This section describes how to perform measurements in the modulation analysis (Demod) mode.



**Figure 3–25: Demod menu structure**

There are three items in the Demod menu:

- **Analog Demod.** Performs analog modulation analysis. Refer to page 3–34 for details.
- **Standard...** Performs modulation analysis according to a communication standard. No function is included currently.

## Measurement Screen Layout

The following three views are displayed on screen by default in the Demod mode (see Figure 3–26):

- Overview:** Displays all data in one acquisition block. The Timing field at the bottom of the overview indicates the contents of the main view and the subview, as well as the trigger point. For information about the trigger point, refer to *Trigger Point Indicator* on page 3–101.
- Main view:** Displays the measurement results and waveform for the range specified by the green horizontal line in the overview. Some measurements show the results and waveform separately on the right and left sides of the main view.
- Subview:** Displays the spectrum (default). The FFT processing range is indicated by the pink horizontal line shown in the overview.

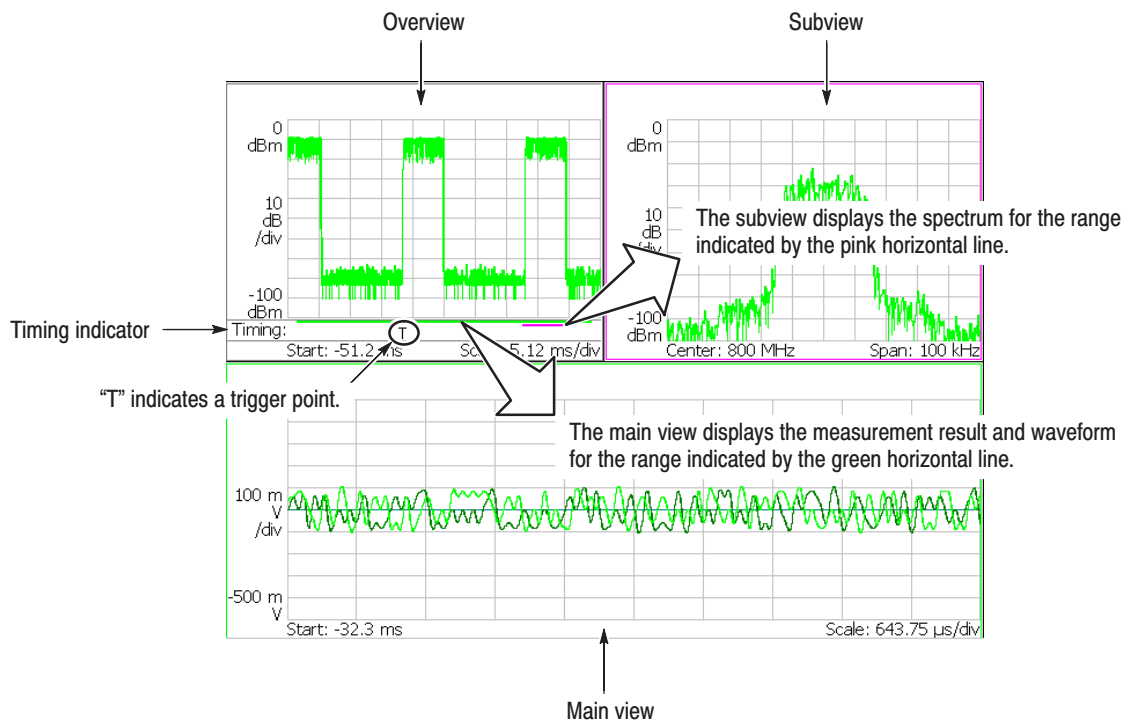


Figure 3–26: Demod mode screen

## Setting the Analysis Range

The analysis is performed for the range specified in the overview (see Figure 3–27), and then the measurement result and waveform are displayed in the main view. Set the analysis range after data acquisition with the following procedure, using the Timing menu. The range is indicated by green lines.

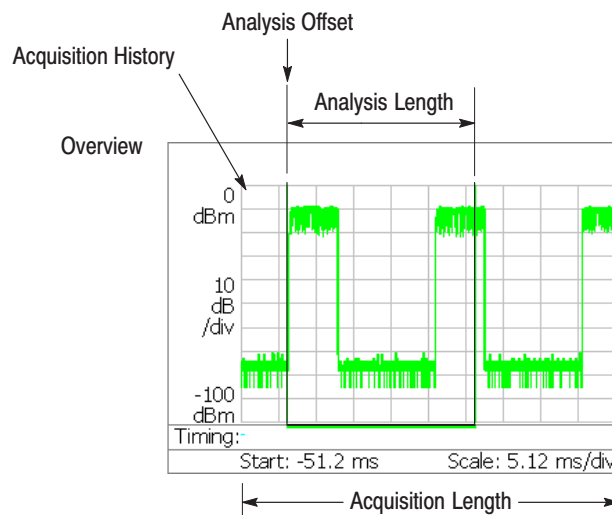
1. Press the **TIMING** key on the front panel.
2. Set the time length to acquire one block by pressing the **Acquisition Length** side key.

Suppose that one block contains N frames; the acquisition length is calculated with this equation:

$$(\text{One block acquisition length}) = N \times (\text{One frame acquisition length})$$

One frame acquisition length is determined by span and indicated on the **Spectrum Length** side key.

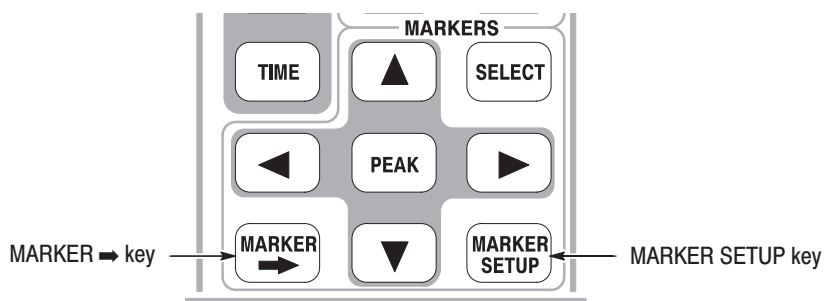
3. *For data acquired in the continuous mode:*  
Specify the number of the block to be analyzed by pressing the **Acquisition History** side key. 0 (zero) represents the latest block.
4. Specify the time length of analysis range by pressing the **Analysis Length** side key.
5. Specify the start point of the analysis range by pressing the **Analysis Offset** side key.



**Figure 3–27: Analysis range setting in the overview**

**Specifying Origin of Analysis Range Using the Marker.** You can also use the marker (□) in place of the **Analysis Offset** side key to specify the origin of analysis range. Do the following steps in place of step 5 on the previous page.

1. Press the **MARKERS: SETUP** key on the front panel (see Figure 3–28).
2. Press the **Markers** side key to select **Single**.  
The marker (□) appears on the screen.
3. Rotate the general purpose knob to move the marker to the measurement starting point.
4. Press the **MARKER →** key on the front panel and then press the **Analysis Time = Marker Time** side key. The green line resizes to the specified range.

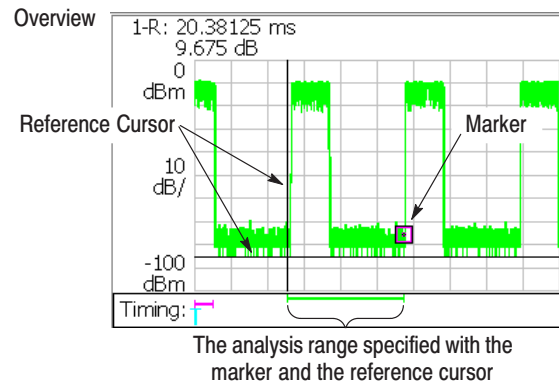


**Figure 3–28: MARKERS keys**

**Specifying Analysis Range Using the Marker and Reference Cursor.** You can use the marker and the reference cursor in place of the **Analysis Length** and the **Analysis Offset** side keys to specify the analysis range. Perform the following steps in place of steps 4 and 5 on the previous page.

1. Press the **VIEW: SELECT** key on the front panel to select the overview.
2. Press the **MARKERS: SETUP** key on the front panel.
3. Press the **Markers** side key to select **Single**.  
The marker (□) appears on the screen.
4. Rotate the general purpose knob to move the marker to the measurement start point.
5. Press the **Reference Cursor to Marker X** side key.  
The reference cursor appears at the marker position (see Figure 3–29).
6. Rotate the general purpose knob to move the marker to the measurement end point.

- Press the **MARKER**  $\Rightarrow$  key on the front panel and then press the **Analysis Time = Marker Time** side key. The green line resizes to the specified range.



**Figure 3-29: Specifying the range with the marker and the reference cursor**

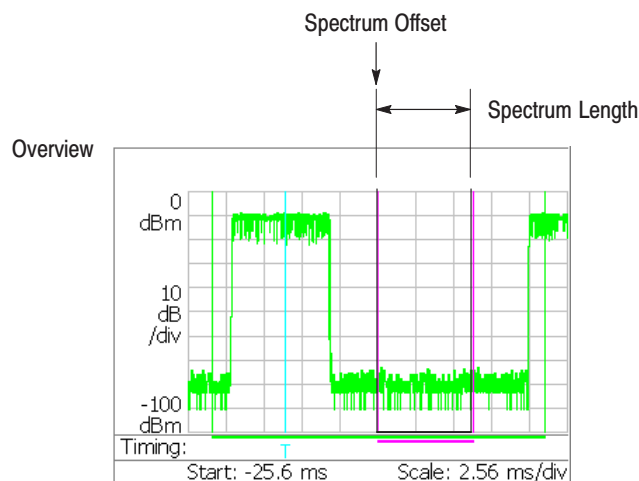
### Setting FFT Processing Range for the Subview

Set the FFT processing range (shown in Figure 3-30) for the spectrum displayed in the subview with the following procedure using the Timing menu after data acquisition. The range is indicated by a pink line.

- Press the **TIMING** key on the front panel.

The **Spectrum Length** side key shows the time for creating the FFT available in the subview. It is determined by the span internally.

- Press the **Spectrum Offset** side key and specify the beginning of the range using the general purpose knob or numeric input keypad.



**Figure 3-30: FFT processing range setting on the overview**

### Changing the Overview

By default, the overview shows the waveform representing the signal amplitude variation over time. You can change the overview with the following steps:

1. Press the **VIEW: DEFINE** key on the front panel.
2. Press the **Overview Content...** side key and select the overview (see Figure 3–31):
  - Waveform (Amplitude versus Time)
  - Spectrogram

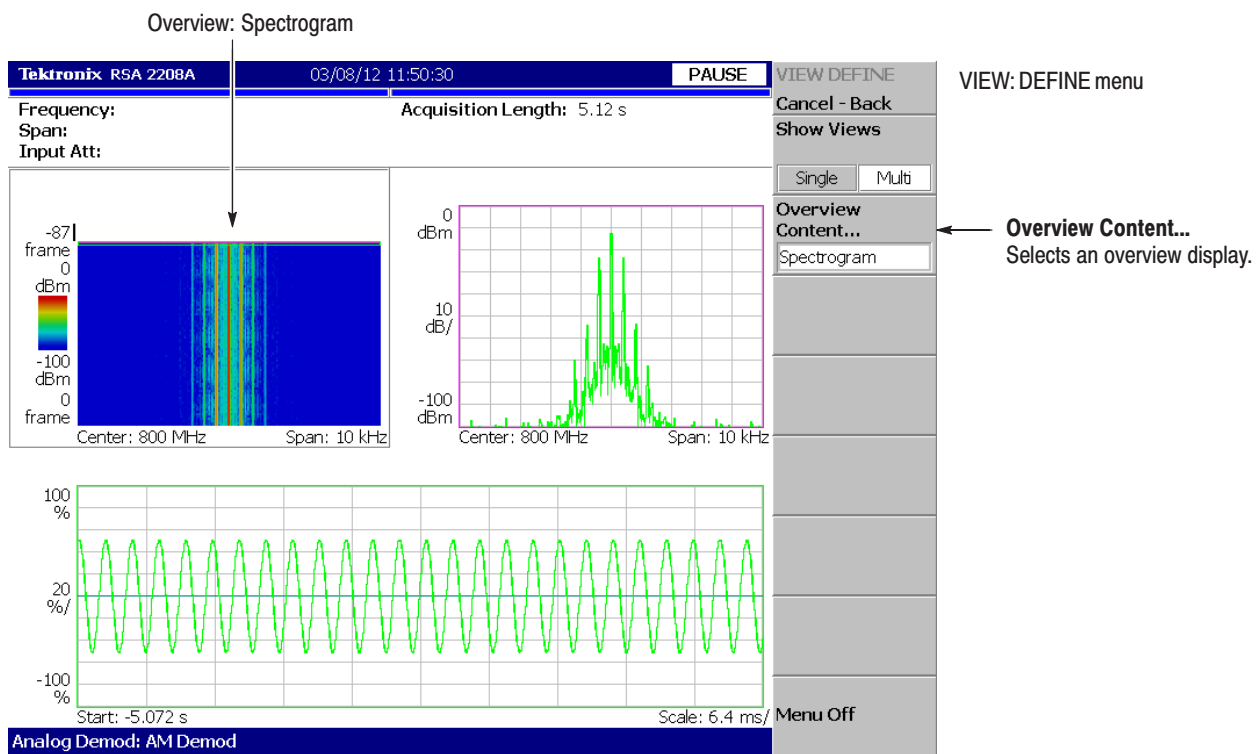


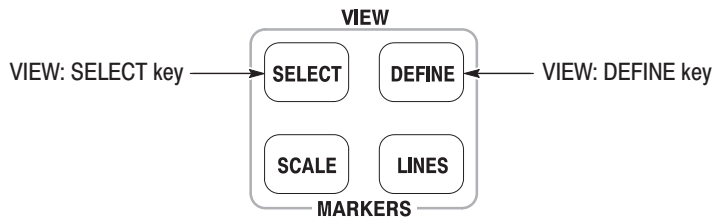
Figure 3–31: Changing the overview



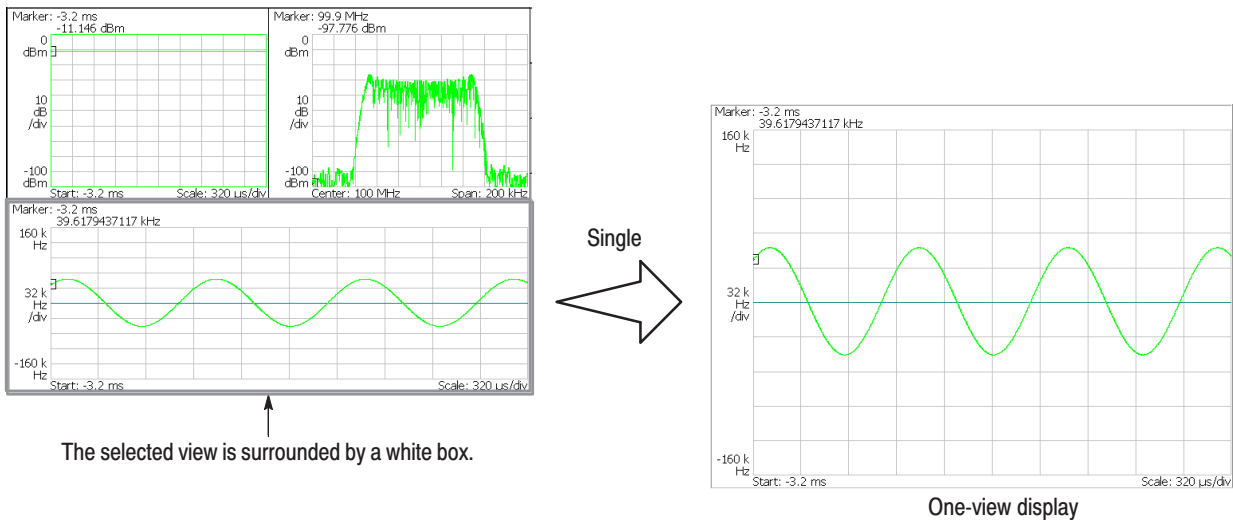
### One-View Display

Three views are displayed on screen by default. To display one view, perform the following steps:

1. Press the VIEW: **DEFINE** key on the front panel.



2. Select a view to make the single display by pressing the **SELECT** key in the VIEW area. The selected view is surrounded by a white box.
3. Press the **Show Views** side key to select **Single**.  
Figure 3–32 shows the one view display.



**Figure 3–32: One-view display**

## Analog Modulation Analysis

You can select the following measurement items with the **MEASURE** key when you select **Analog Demod** in the Demod menu.

- AM Demod page 3–36
- FM Demod page 3–37
- PM Demod page 3–39
- IQ versus Time page 3–40
- Pulse Spectrum page 3–41

### Basic Procedure

Follow this procedure to perform analog modulation analysis:

1. Press the **MODE: DEMOD** key on the front panel.
2. Press the **Analog Demod** side key.
3. Select a measurement item.
4. Display the measurement waveform:

---

**NOTE.** You should set appropriate frequency and span. It is important to set frequency and span as close to the measurement signal band as possible and finely adjust them. The modulated signal will not be recognized unless frequency and span are set appropriately.

For information about setting frequency, span, and amplitude, refer to Setting Frequency and Span on page 3–63 and Setting Amplitude on page 3–71.

---

- a. Set frequency by pressing the **FREQUENCY/CHANNEL** key on the front panel.
  - b. Set span by pressing the **SPAN** key on the front panel.
  - c. Set amplitude by pressing the **AMPLITUDE** key on the front panel.
5. Set analysis range by pressing the **TIMING** key on the front panel. Refer to page 3–29 for information about setting the analysis range.
  6. Set the measurement parameters by pressing the **MEAS SETUP** key on the front panel. For the Meas Setup menu, refer to the following sections.

**ASK/FSK Modulation Analysis.** Basic ASK and FSK modulation analysis can be performed using Analog Modulation Analysis. This analysis includes frequency deviation and depth of modulation. Typical settings are as follows:

■ ASK signal measurement

Measurement item . . . AM Demod  
Span . . . . . 500 kHz  
Acquisition Length . . . 10.24 ms

■ FSK signal measurement

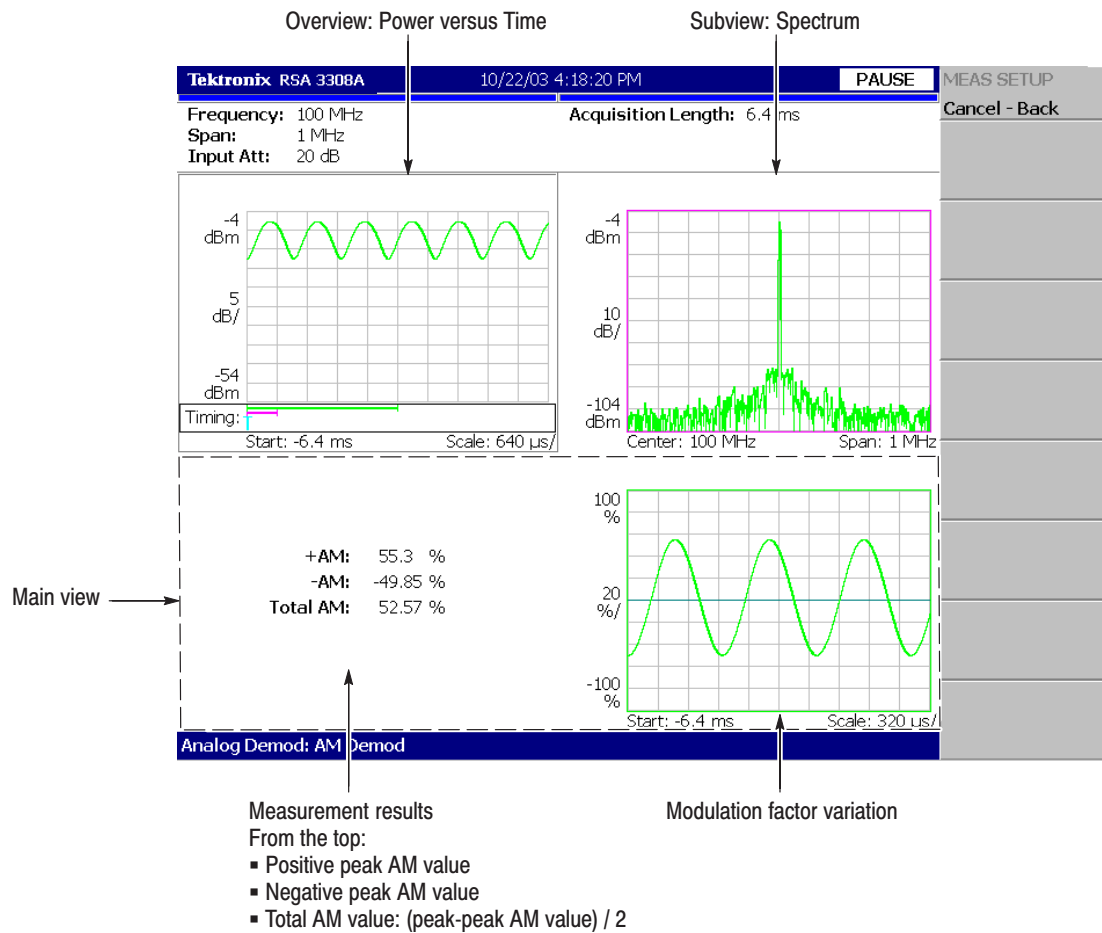
Measurement item . . . FM Demod  
Span . . . . . 500 kHz  
Acquisition Length . . . 10.24 ms  
Vertical Scale . . . . . 1.6 MHz (deviation scale: 800 kHz)

The following pages show examples for each measurement item. Refer to page 3–123 for information about setting scale and formatting each view. Refer to page 3–32 for information about changing the overview and subview.

**AM Demod Measurement**

Demodulates and measures an AM signal. Figure 3–33 shows an example. The main view displays the measurement results and the modulation factor versus time graph. **MEASURE** → **Show Measurements** is selected in Figure 3–33.

The AM demod measurement has no Meas Setup menu items.



**Figure 3–33: AM demod measurement**

**FM Demod Measurement**

Demodulates and measures an FM signal. Figure 3–34 shows an example. The main view displays the measurement results and the frequency deviation versus time graph. **MEASURE** → **Show Measurements** is selected in Figure 3–34.

**Meas Setup Menu.** The Meas Setup menu for the FM demod measurement contains the following controls:

**Auto Carrier.** Determines whether to detect the carrier automatically.

- **On. Default.** Automatically detects the carrier for every frame. The error from the center frequency is shown on the **Freq Error** side key.
- **Off.** Sets the carrier frequency using **Frequency Offset** described below.

**Frequency Offset.** Sets the carrier frequency when Off is selected in Auto Carrier. Enter the carrier offset from the center frequency.

Range: –30 to +30 MHz

**Threshold.** Sets the threshold level above which the input signal is determined to be a burst in time domain. The burst detected first is used for the measurement.

Range: –100.0 to 0.0 dB

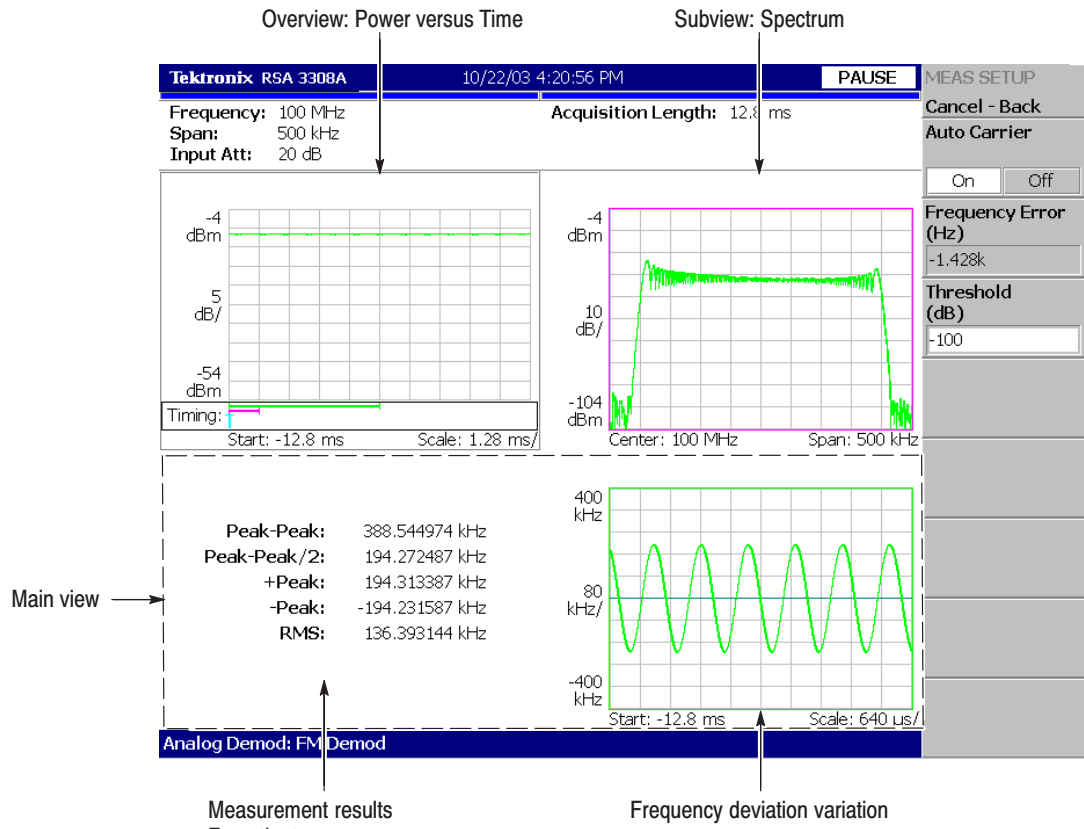


Figure 3-34: FM demod measurement

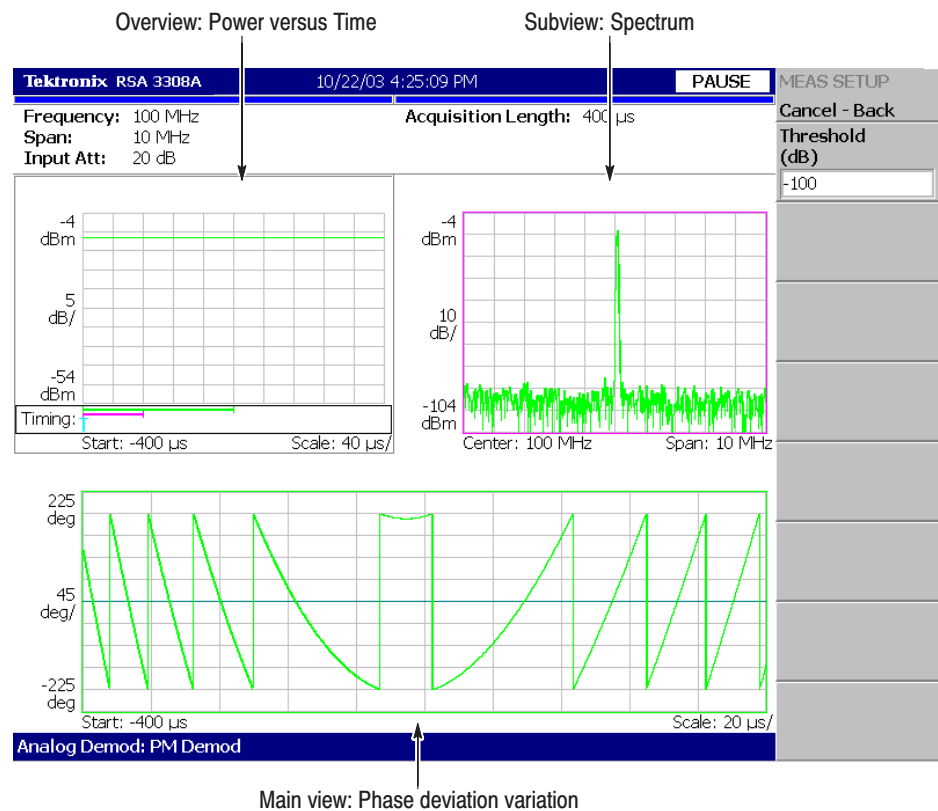
**PM Demod Measurement**

Demodulates and measures a PM signal. Figure 3–35 shows an example. The main view displays the phase error versus time graph.

**Meas Setup Menu.** The Meas Setup menu for the PM demod measurement contains the following control:

**Threshold.** Sets the threshold level above which the input signal is determined to be a burst in time domain. The burst detected first is used for the measurement.

Range: –100.0 to 0.0 dB



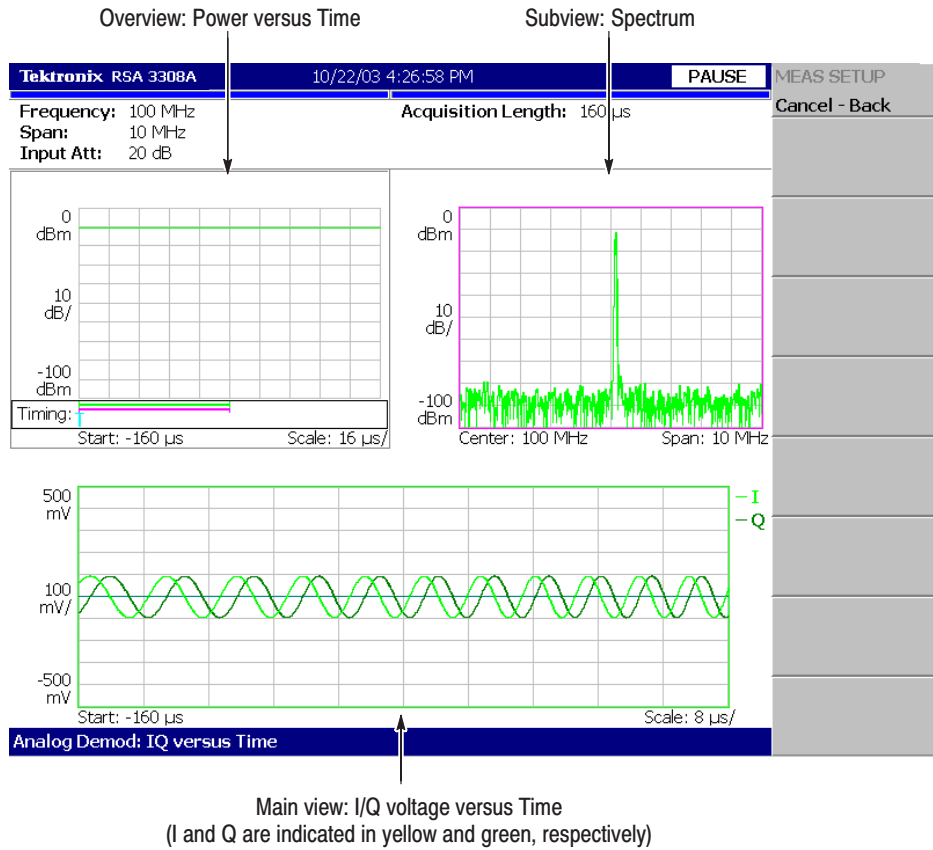
**Figure 3–35: PM demod measurement**

You can select degree or radian for the angular unit by pressing **SYSTEM** → **Instrument Setup...** → **Angular Units**.

**IQ versus Time Measurement**

Measures I and Q level over time. Figure 3–36 shows an example. The main view shows the I/Q voltage versus time graph. I and Q are indicated in yellow and green, respectively.

The IQ level measurement has no Meas Setup menu items.



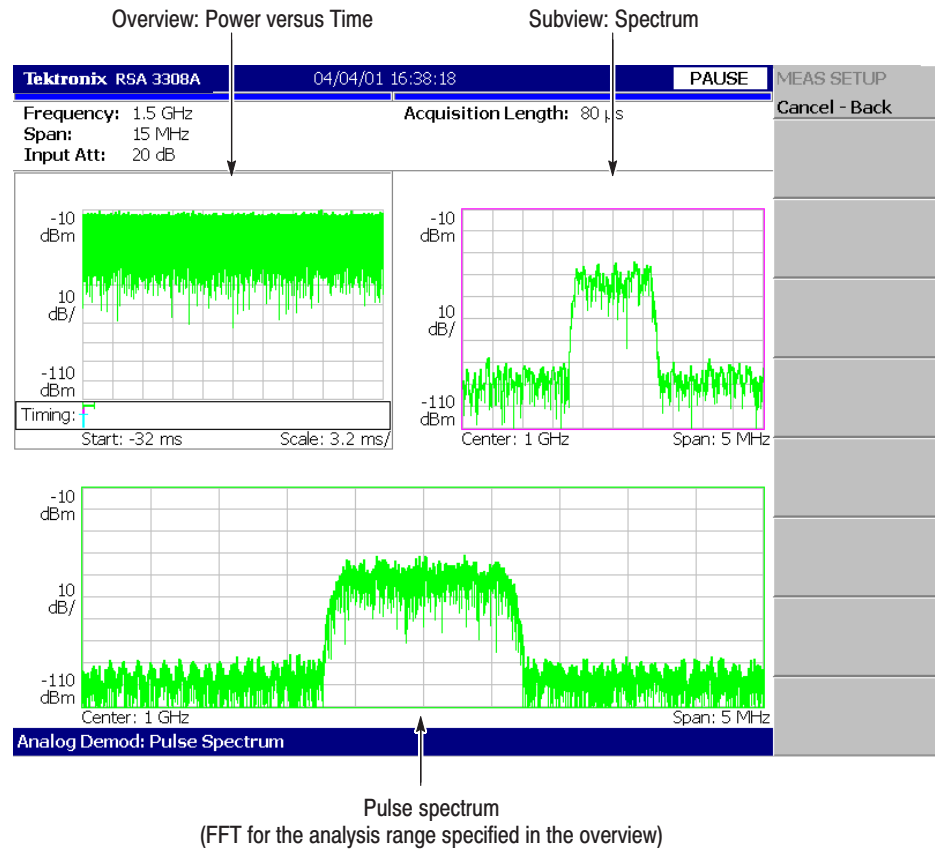
**Figure 3–36: IQ versus time measurement**



**Pulse Spectrum Measurement**

Performs FFT for the analysis range specified in the overview. On specifying the analysis range, refer to *Setting Analysis Range* on page 3–29. Figure 3–37 shows the pulse spectrum measurement. The main view shows the pulse spectrum (FFT for the analysis range).

The pulse spectrum measurement has no Meas Setup menu items.

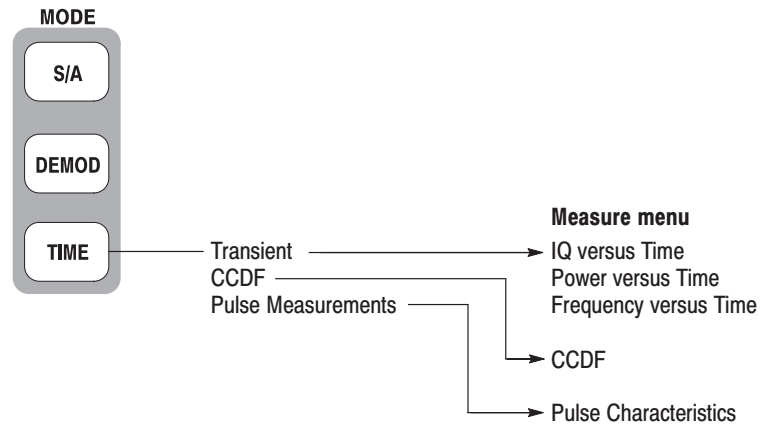


**Figure 3–37: Pulse spectrum measurement**



# Time Analysis (Time Mode)

This section describes how to perform measurements in the time analysis (Time mode).



**Figure 3–38: Time menu structure**

There are three items in the Time menu:

- **Transient.** Performs time variation measurement.  
Refer to page 3–44 for details.
- **CCDF.** Performs CCDF measurement.  
Refer to page 3–48 for details.
- **Pulse Measurements.** Performs pulse measurements.  
Refer to page 3–53 for details.

## Measurement Screen Layout

The measurement screen layout in the time analysis (Time mode) is the same as in the modulation analysis (Demod mode). Refer to *Measurement Screen Layout* on page 3–28 for the view functions, setting an analysis range, and changing the view content.

## Time Variation Measurement

You can select the following time variation measurement items using the **MEASURE** key when you select **Transient** in the Time menu.

- IQ versus Time
- Power versus Time
- Frequency versus Time

The time variation measurements have no Meas Setup menu items.

### Basic Procedure

Follow these steps to perform the time variation measurement:

1. Press the **MODE: TIME** key on the front panel.
2. Press the **Transient** side key and select a measurement item.
3. Display the measurement waveform:

---

**NOTE.** *You should set appropriate frequency and span. It is important to set frequency and span as close to the measurement signal band as possible and finely adjust them. The modulated signal will not be recognized unless frequency and span are set appropriately.*

*For details on setting frequency, span, and amplitude, refer to Setting Frequency and Span on page 3–63 and Setting Amplitude on page 3–71.*

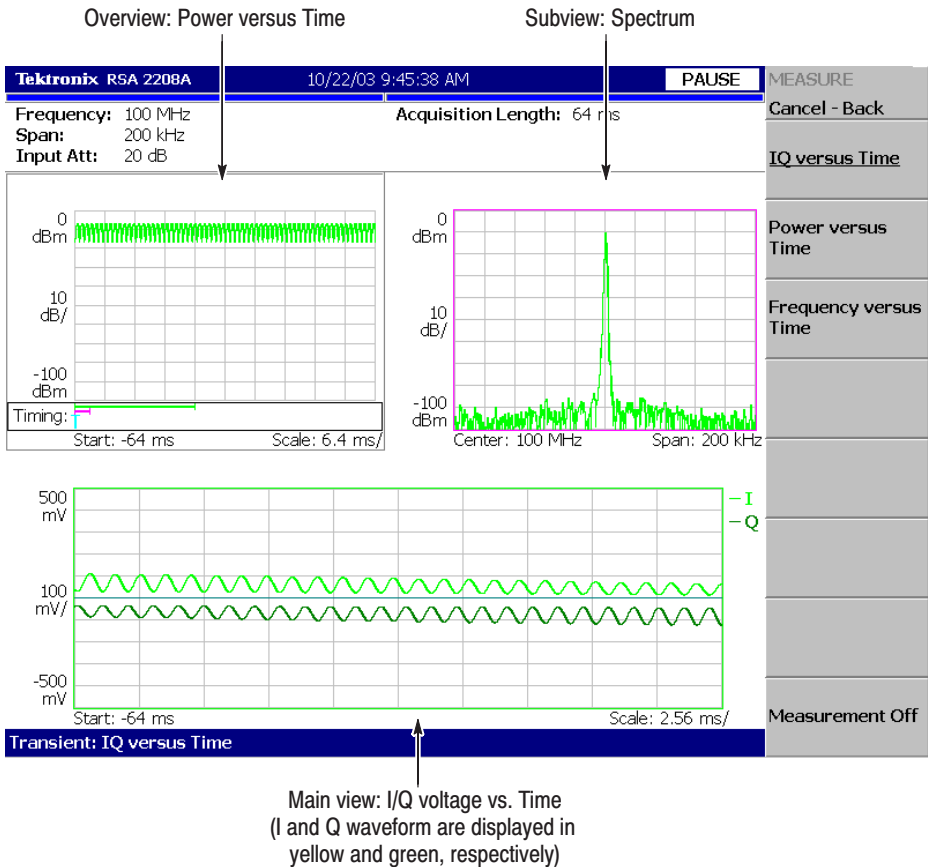
---

- a. Set the frequency by pressing the **FREQUENCY/CHANNEL** key on the front panel.
  - b. Set the span by pressing the **SPAN** key on the front panel.
  - c. Set the amplitude by pressing the **AMPLITUDE** key on the front panel.
4. Set the analysis range by pressing the **TIMING** key on the front panel. Refer to page 3–29 for details about setting analysis range.

The following pages show the examples for each measurement item. Refer to page 3–123 for information about setting scale and formatting each view. Refer to page 3–32 for information about changing the overview.

**IQ versus Time Measurement**

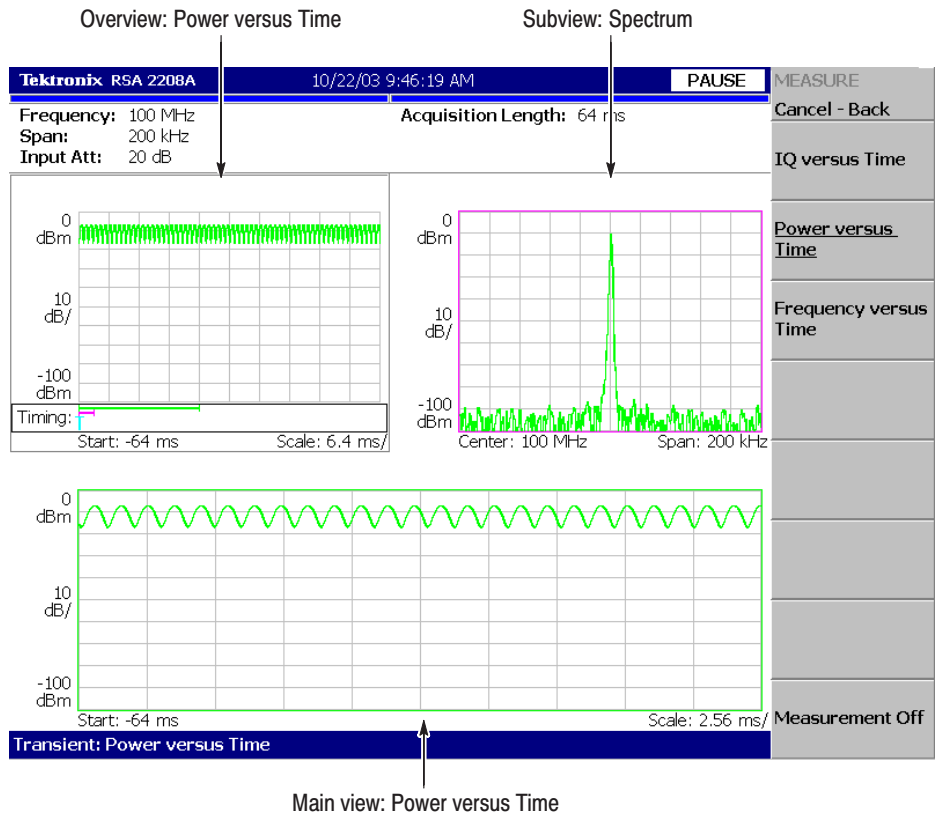
Observes I and Q signal level over time. Figure 3-39 shows an example. The main view displays I/Q voltage versus time. I and Q are indicated in yellow and green, respectively.



**Figure 3-39: IQ versus Time measurement**

**Power versus Time Measurement**

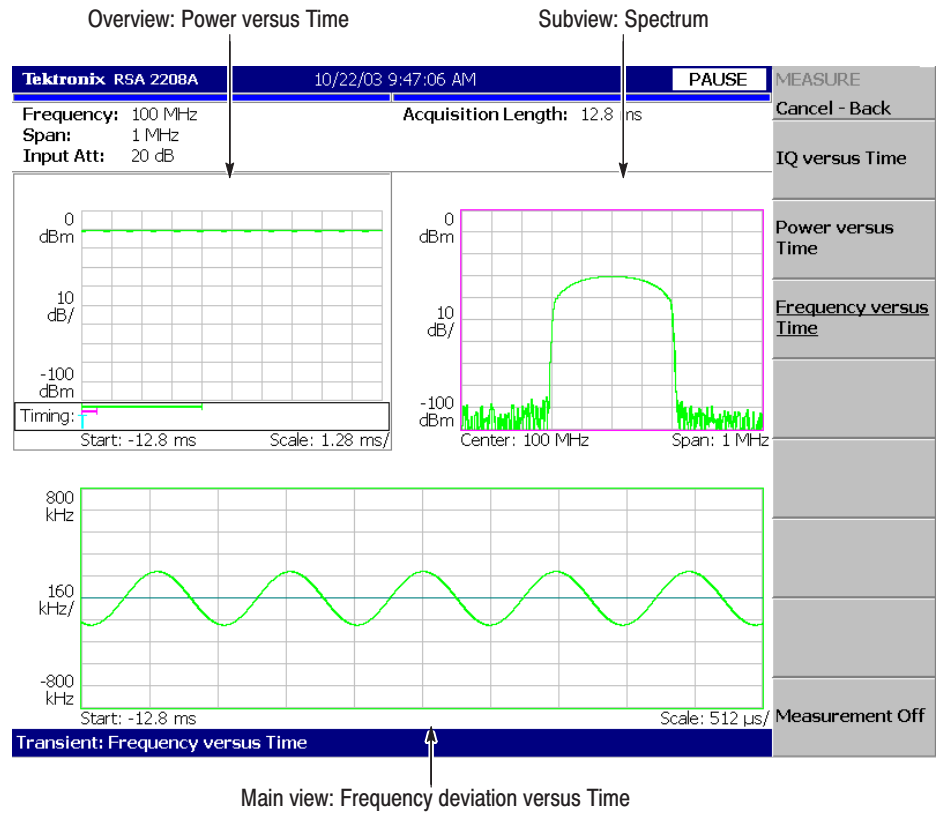
Observes signal power change over time. Figure 3–40 shows an example. The main view displays power level versus time.



**Figure 3–40: Power variance measurement**

**Frequency versus Time Measurement**

Observes signal frequency change over time. Figure 3–41 shows an example. The main view displays the frequency deviation from the center frequency versus time.



**Figure 3–41: Frequency measurement**

## CCDF Measurement

CCDF (Complementary Cumulative Distribution Function) represents the probability that the peak power above average power of a measured signal exceeds a threshold. The analyzer displays the ratio of peak power to average power along the horizontal axis, and the probability that the ratio is exceeded along the vertical axis.

This CCDF analysis function and the real-time analysis function allow you to measure the time-varying crest factor in the time series for code-multiplexing signals such as CDMA/W-CDMA signals, and multi-carrier signals such as OFDM signals. This function is useful in designing amplifiers for CDMA/W-CDMA and OFDM.

### CCDF Calculation Process

The CCDF analysis obtains the distribution of the amplitude of observed signals and makes a graph of accumulation from the threshold. CCDF is calculated using this formula:

$$SP(X) = \int_X^{Max} P(Y) dY$$

$$CCDF(X) = SP(X + Average)$$

$$CCDF(crest\ factor) = 0$$

where  
 P = Probability density of amplitude  
 Max = Maximum of amplitude  
 Average = Average of amplitude

The analyzer processes input signals internally using the following procedure (see Figure 3–42):

1. Measure the amplitude of the input signal over time.
2. Determine the amplitude distribution.
3. Obtain CCDF using the above formula.

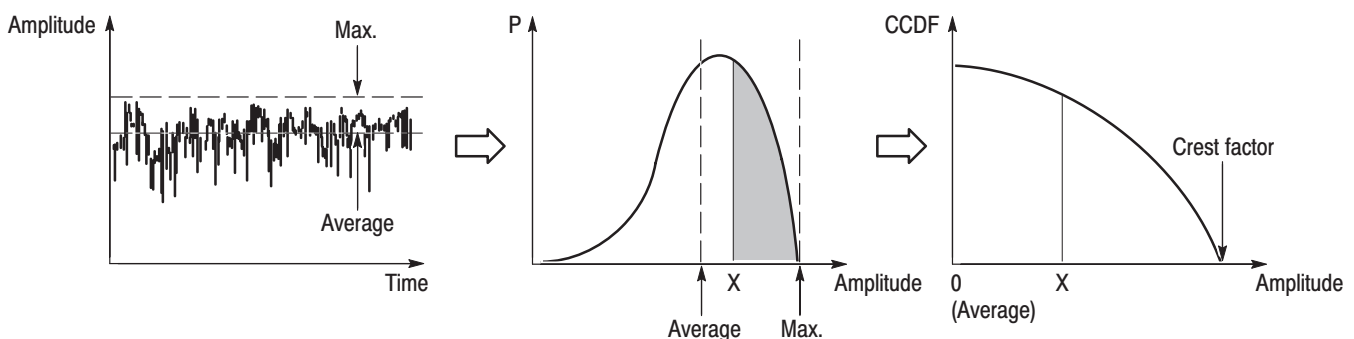


Figure 3–42: CCDF calculation process



**Basic Procedure**

Follow these steps to perform the CCDF measurement:

1. Press the **TIME** key on the front panel.
2. Press the **CCDF** side key.
3. Display the measured waveform.

---

**NOTE.** Make sure to set the proper frequency and span. It is important to set the frequency and the span as close to the measured signal bandwidth as possible and adjust precisely. If not, modulated signals are not recognized correctly.

For details about setting frequency, span, and amplitude, refer to Setting Frequency and Span on page 3–63 and Setting Amplitude on page 3–71.

---

- a. Press the **FREQUENCY/CHANNEL** key on the front panel to set the frequency.
  - b. Press the **SPAN** key on the front panel to set the span.
  - c. Press the **AMPLITUDE** key on the front panel to set the amplitude.
4. Set the analysis range by pressing the **TIMING** key on the front panel. Refer to page 3–29 for details about setting the analysis range.

---

**NOTE.** The CCDF measurement does not have Analysis Length and Analysis Offset controls in the Timing menu.

---

5. Set the measurement parameters described just below by pressing the **MEAS SETUP** key on the front panel.

**Single Acquisition.** In single acquisition mode, you can set the total number of accumulated data points with **TRACE/AVG** → **Maximum Points**, ranging from 2048 to  $10^{15}$ .

### **Meas Setup Menu**

The Meas Setup menu for the CCDF measurement contains the following controls:

**Display Gaussian Line.** Determines whether to display Gaussian line on screen.

**Display Reference Line.** Determines whether to display the most recently stored reference line on screen.

**Store Reference Line.** Stores the current CCDF curve as a new reference line. Automatically enables the reference line display.

**Reset Measurement.** Performs the CCDF calculation again from the beginning. The calculation is performed accumulatively until this side key is pressed.

**CCDF Auto-Scaling.** Selects whether to fix the scale of the horizontal axis (amplitude) of CCDF graph display.

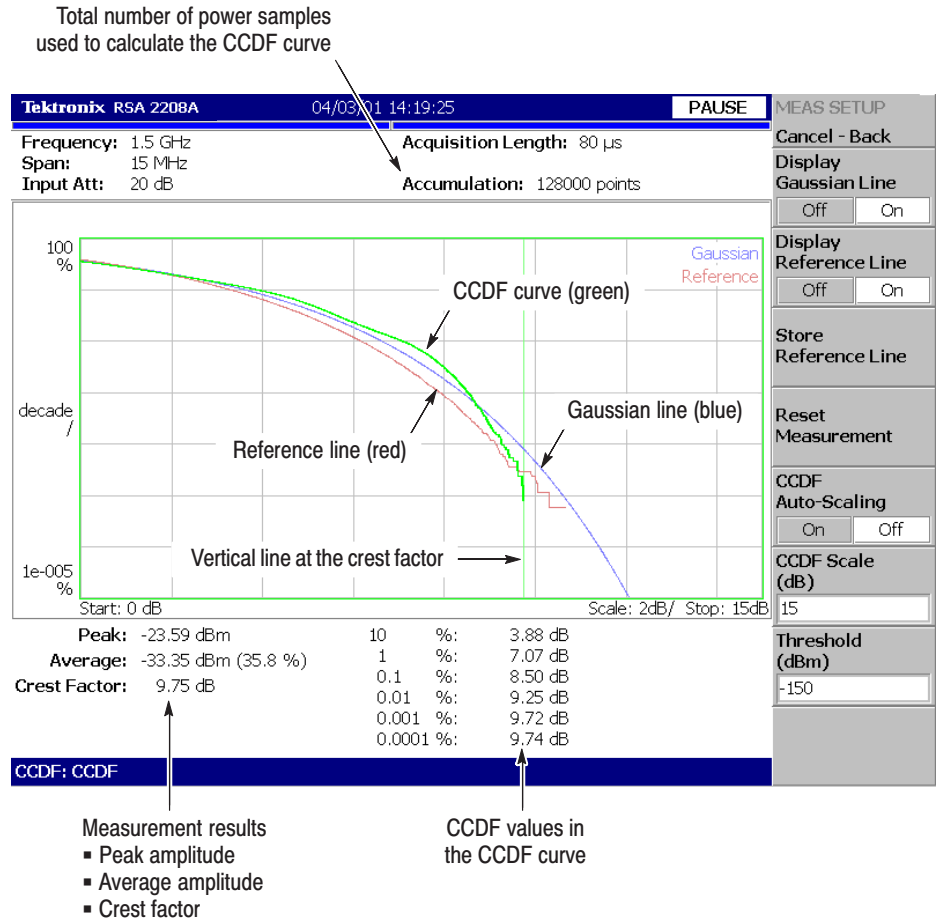
- **Off. Default.** The scale of the horizontal axis is set to a fixed value using CCDF Scale.
- **On.** Displays the graph with the signal peak value as the maximum value (right edge) of the horizontal axis.

**CCDF Scale.** Sets the full-scale of the horizontal axis of CCDF graph display when CCDF Auto Scaling is Off. Range: 1 to 100 dB.

**Threshold.** Sets the threshold which defines the samples to be included in the CCDF calculation. Range: -250 to 130 dBm.

**Measurement Display**

Figure 3–43 shows an example of the CCDF measurement.



**Figure 3–43: CCDF single view**

### Changing the View

You can change the contents of the views by pressing the VIEW: **DEFINE** key with the following controls:

**Show Views.** Selects the view style:

- **Single.** Displays only the view selected by the VIEW: **SELECT** key.
- **Multi.** Displays the overview, the subview, and the main view.

**Overview Content...** Selects the content of the overview:

- Spectrogram
- Waveform (power versus time)

Refer to page 3–123 for information about setting the view scale and format. Figure 3–44 shows an example of the CCDF multi-view.

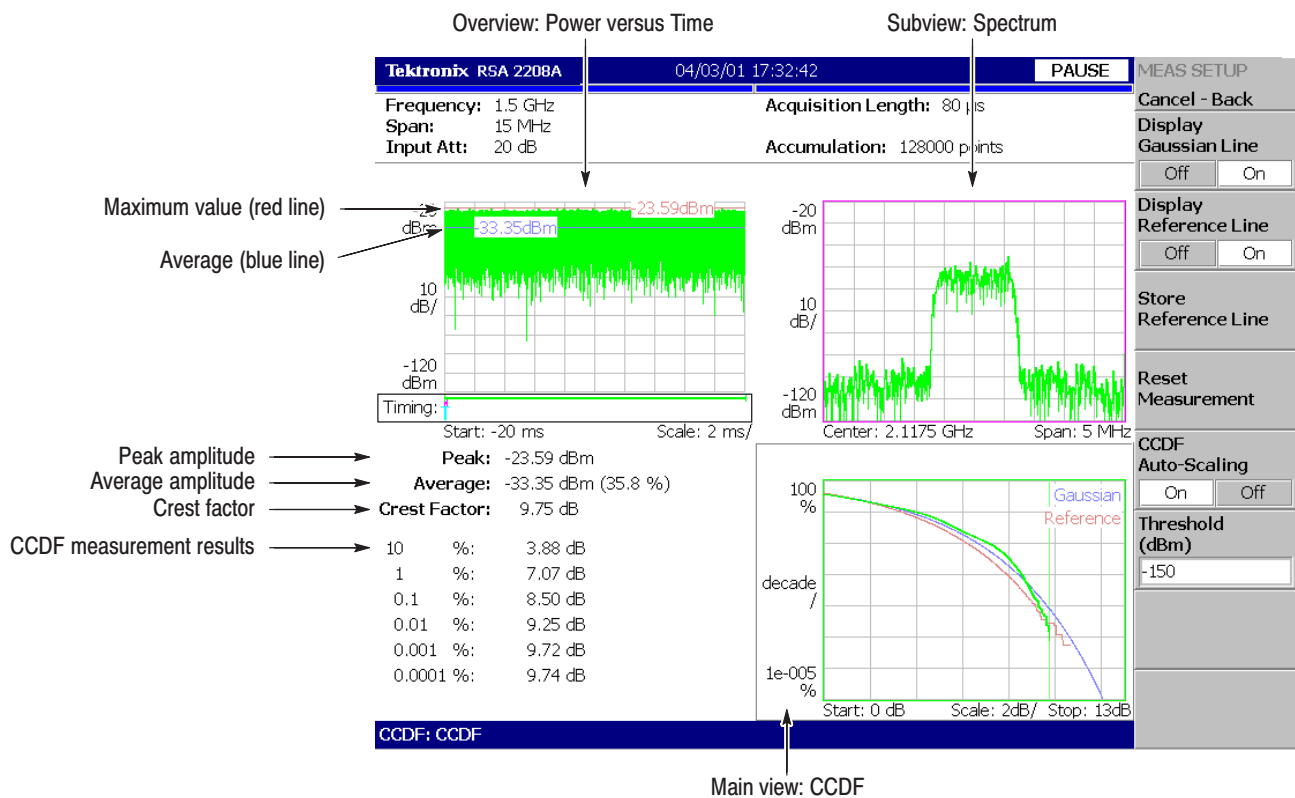


Figure 3–44: CCDF multi-view

## Pulse Measurements

This section describes how to perform the pulse measurements. Select **TIME** → **Pulse Measurements** → **Pulse Characteristics** to measure various pulse characteristics.

### Measurement Items

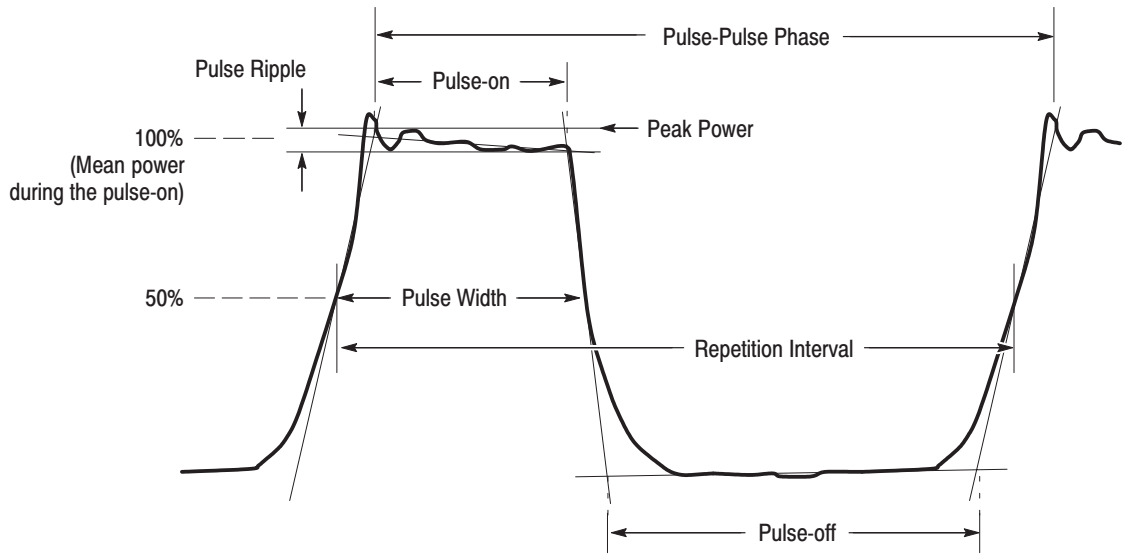
The following lists shows the measurement items (Measure menu) for pulse characteristics and their definitions (see Figure 3–45).

- **Pulse Width.** Measures the time from rising edge to falling edge at the level of  $-3$  dB (50%) of the mean power for the pulse-on.
- **Peak Power.** Measures the maximum power during the pulse-on.
- **On/Off Ratio.** Measures the ratio of the mean power during the pulse-on to that during the pulse-off time.
- **Pulse Ripple.** Measures the difference between the maximum and the minimum power during the pulse-on.
- **Repetition Interval.** Measures the time from a pulse rising edge to the next pulse rising edge.
- **Duty Cycle.** Measures the ratio of the pulse width to the repetition interval.
- **Pulse-Pulse Phase.** Measures the phase difference between the first pulse and the selected pulse in the analysis window.
- **Channel Power.** Measures the channel power for the pulse-on spectrum.
- **OBW.** Measures the OBW (Occupied Bandwidth) for the pulse-on spectrum.
- **EBW.** Measures the EBW (Emission Bandwidth) for the pulse-on spectrum.
- **Frequency Deviation.** Measures the signal frequency change from the center frequency over time during the pulse-on.

For information about Channel Power, OBW and EBW measurements, refer to the S/A (Spectrum Analysis) mode.

Channel Power	page 3–5
OBW	page 3–11
EBW	page 3–14

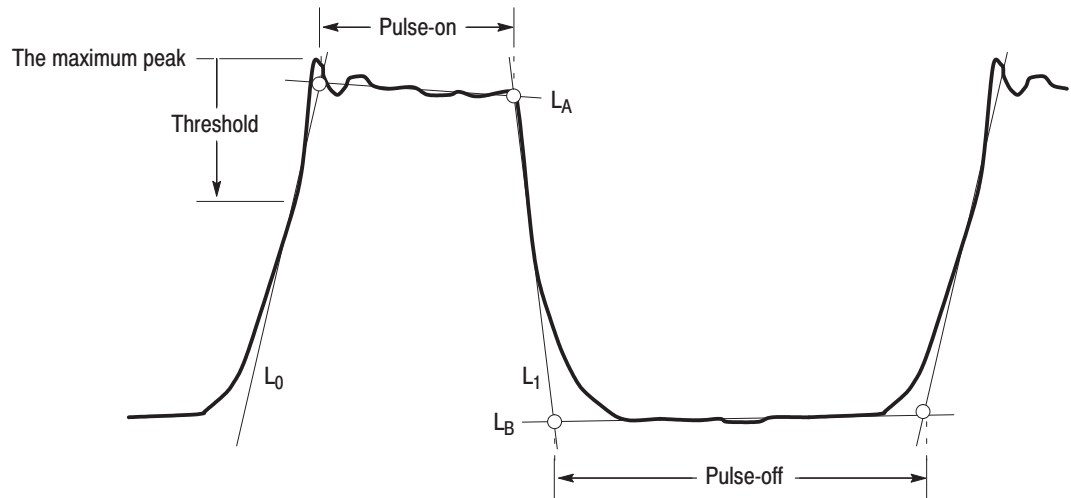
The frequency deviation measurement is based on the Frequency versus Time measurement in the Transient mode. Refer to page 3–47.



**Figure 3-45: Definition of pulse characteristics**

**Definition of Pulse-On/Off Time**

The pulse-on and -off times are fundamental parameters for pulse measurements. These parameters are defined in Figure 3-46. The threshold is a level to detect a pulse, relative to the maximum peak in the acquired data. You can set it by using Detection Threshold in the Meas Setup menu (refer to page 3-60).



**Figure 3-46: Definition of pulse-on/off**

The  $L_0$ ,  $L_1$ ,  $L_A$ , and  $L_B$  lines represent the following:

- $L_0$ : Tangent line through the threshold point on the rising edge
- $L_1$ : Tangent line through the threshold point on the falling edge
- $L_A$ : Regression line calculated on the pulse top
- $L_B$ : Regression line calculated on the pulse bottom

These lines are displayed in red in the subview. The pulse-on and -off times are determined by the nodes of these lines as shown in Figure 3–46.

### Basic Measurement Procedure

Use this procedure to perform the pulse measurements:

1. Press the **TIME** key on the front panel.
2. Press the side key **Pulse Measurement** → **Pulse Characteristics**.
3. Display the measurement waveform:
  - a. Press the **FREQUENCY/CHANNEL** key on the front panel to set the frequency.
  - b. Press the **SPAN** key on the front panel to set the span.
  - c. Press the **AMPLITUDE** key on the front panel to set the amplitude.

For information about setting frequency, span, and amplitude, refer to *Setting Frequency and Span* on page 3–63 and *Setting Amplitude* on page 3–71.

4. *For the channel power, OBW, and EBW measurements only:*  
You can select an FFT window for the measurement.  
Refer to *RBW/FFT Menu* on page 3–57.
5. Press the **TIMING** key on the front panel to set the analysis range.  
Refer to page 3–29 for details on setting analysis range.
6. Press the **VIEW: DEFINE** key on the front panel to select the measurement item(s) for display. Refer to page 3–57 for the View Define menu.  
  
By default, only the pulse-width measurement result is displayed on screen.
7. Press the **MEAS SETUP** key on the front panel to set the measurement parameters. Refer to page 3–60 for the Meas Setup menu.

8. After you capture a measurement waveform, stop the data acquisition.  
If you are acquiring data in the continuous mode, press the **RUN/STOP** key.
9. Press the **MEAS SETUP** key and then **Analyze** side key to start the analysis of the acquired data.
10. Press the **VIEW: DEFINE** key to select a pulse to observe from the measurement results.

#### **Hints for Taking Measurements.**

- It takes longer to detect pulses when the analysis length in the Timing menu is set to a larger value.
- The results are not displayed in the Channel Power, OBW, or EBW measurement.

The number of data samples in Pulse-On must be 20 to 16,384 for FFT calculation. Change the span to display the results.

- The results are not displayed in the Pulse Repetition Interval or the Duty Cycle measurement.

The observed pulse and the next one must be contiguous. If either pulse is not recognized due to noise and so on, the measurement results are not shown.

#### *Error messages (displayed on the bottom of the screen)*

- Message: Filter bandwidth is too wide or Channel bandwidth is too wide.  
Indicates that you set Filter Bandwidth or Channel Bandwidth inappropriately in the Meas Setup menu (refer to page 3–60).

In this case, change the setting of Filter Bandwidth or Channel Bandwidth until the message disappears.

- Message: Too long pulse.  
Indicates that the number of data samples of a pulse width exceeds about 260,000.

In this case, change the span.

- Message: Too long repetition interval.  
Indicates that the number of data samples of a pulse repetition interval exceeds about 260,000.

In this case, change the span.



**RBW/FFT Menu**

The RBW/FFT menu for the pulse measurements contains the following controls:

**FFT Window...** Selects an FFT window for the channel power, OBW, and EBW measurements from these two:

- Nyquist (default)
- Blackman-Harris 4B

**Rolloff Ratio...** Sets the roll-off ratio for the Nyquist window.  
Range: 0.0001 to 1 (default: 0.2)

For details on FFT and RBW, refer to page 3–103.

**View Define Menu**

The View Define menu for the pulse measurements contains the following controls:

**Show Views.** Selects a single view or multi-view display.

- **Single.** Displays only the view selected by the VIEW: **SELECT** key on the front panel.
- **Multi. Default.** Displays the overview, subview, and main view.

**Overview Content...** Selects a view displayed in the overview.

- Waveform (Power versus Time)
- Spectrogram

Refer to page 3–123 for information about setting views.

**Select Measurement...** Selects a measurement item to display in the subview from the items selected in Displayed Measurement.

**Select Pulse.** Selects a pulse to measure when you select A Single Pulse in View Results For... described below. 0 (zero) represents the most current pulse while larger negative numbers represent subsequent pulses.

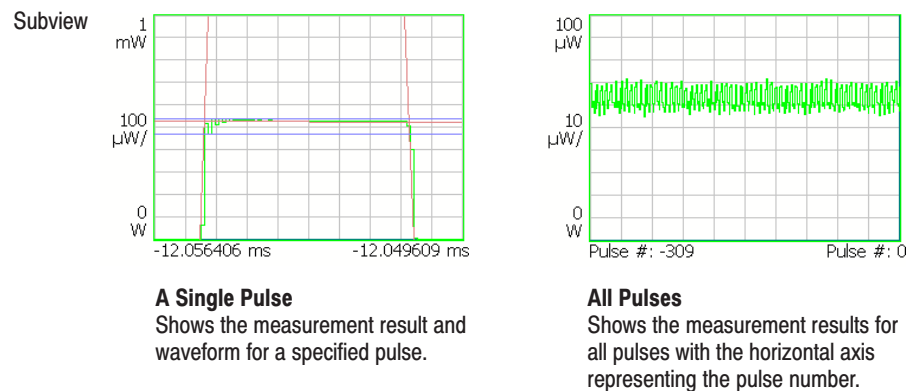
---

**NOTE.** *The main view shows the measurement results for up to 1000 pulses (the pulse number of –999 to 0).*

---

**View Results For...** Selects how to display the measurement results in the subview (see Figure 3–47).

- **A Single Pulse.** Displays the measurement results for one pulse specified with Select Pulse.
- **All Pulses.** Displays the measurement results for all pulses in the analysis range. The horizontal axis represents the pulse number and the vertical axis represents the measurement results.



**Figure 3–47: Setting for View Results For...**

**Displayed Measurement...** Determines whether to show the measurement result in the main view for each measurement item. Select On to show the result. For the measurement items, refer to page 3–53.

---

**NOTE.** You must select at least one measurement item in *Displayed Measurement*. If you turn all items off, an error message “One or more measurement items must be selected” will appear on the bottom of the screen.

---

**Display Time Range...** Selects how to display a pulse in the subview.

- **Adaptive. Default.** Adjusts the horizontal scale for each pulse to fit the pulse width to the subview.
- **Max.** Adjusts the horizontal scale to fit the maximum pulse width in the analysis range to the subview.

**Guidelines...** Determines whether to display the guidelines in the subview.

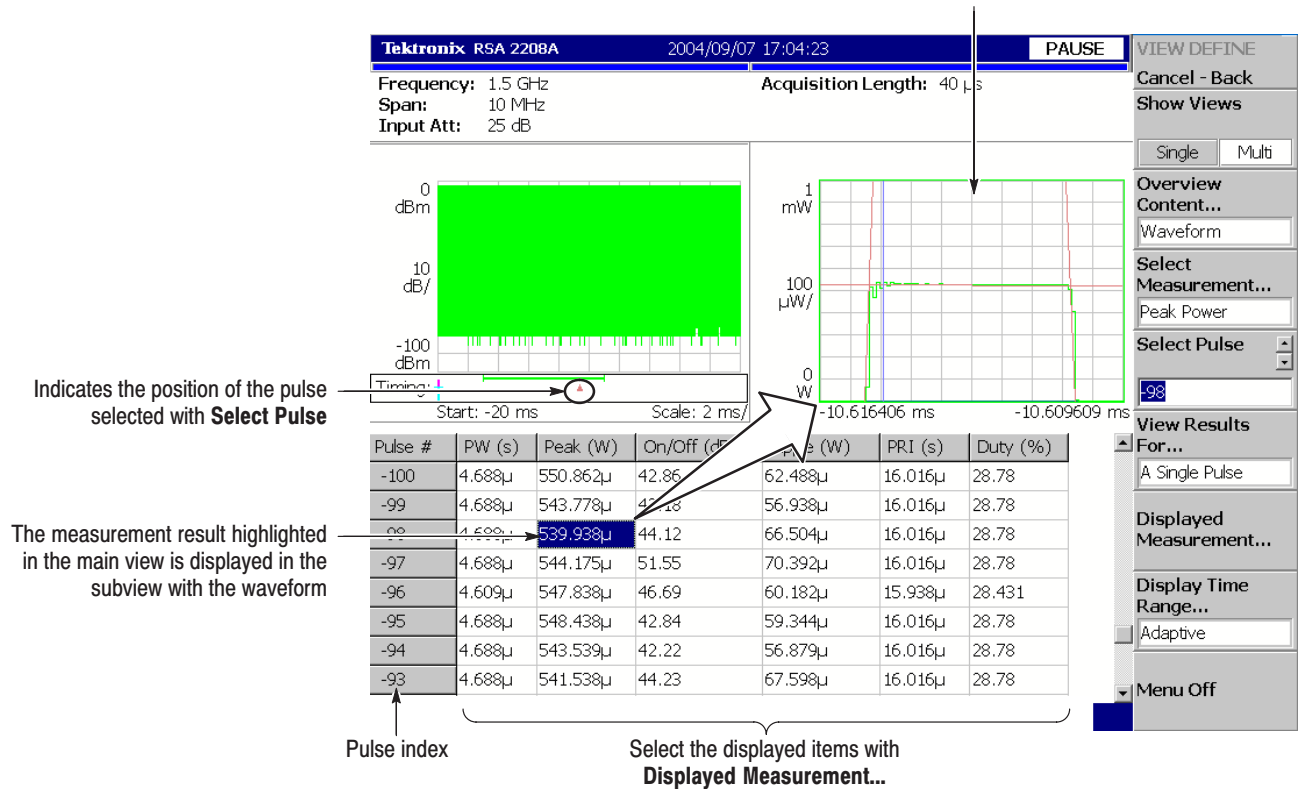
- **On. Default.** Displays the guidelines in the subview.
- **Off.** Hides the guidelines in the subview.

For the guidelines, refer to *Definition of Pulse-On/Off Time* on page 3–54.

**Menu Off.** Turns off the side menu to expand the measurement results and waveform view area on screen. To recall the side menu, press the key on the front panel.

When View Results For... is A Single Pulse:

- Select a pulse with **Select Pulse**
- Select a measurement item with **Select Measurement**



**Figure 3–48: Setting the View Define menu**

## Meas Setup Menu

The Meas Setup menu for the pulse measurements contains the following controls:

**Analyze.** Starts analysis on acquired data in the analysis range.

**Detection Threshold.** Sets the threshold level to detect pulses in acquired data. This level is shown with a green arrow in the subview (see Figure 3–49).  
Range: –100 to 0 dBc (default: –3 dBc)

**Channel Bandwidth.** *For the Channel Power measurement only.*  
Sets the measurement frequency range. Range: (Bin bandwidth)  $\times$  8 to set span. Refer to *Trace Compression* on page 3–120 for the bin bandwidth.

**OBW Power Ratio.** *For the OBW measurement only.*  
Specifies the power ratio of the carrier and span regions for calculating OBW.  
Range: 80 to 99.9% (default: 99% as defined in T–53 or IS–95 standard).

**EBW Meas. Level.** *For the EBW measurement only.*  
Specifies how far down from the peak level the bandwidth is measured.  
Range: –100 to –1 dB (default: –30 dB)

**Counter Resolution.** *For the Frequency Deviation measurement only.*  
Sets the frequency counter resolution. It is the same as in the Carrier Frequency measurement in the S/A mode (refer to page 3–13).  
Range: 1 mHz to 1 MHz in a tenfold sequence (default: 1 Hz)

**P-P Phase Time Offset.** *For the Pulse-Pulse Phase measurement only.*  
Sets the time offset for the measurement point.  
The default value is 0 (zero) second; the measurement point is at the beginning of the pulse-on time.

**Measurement Filter.** Selects the measurement filter applied to time domain I/Q data for each pulse.

- None (no filter)
- Gaussian

**Filter Bandwidth.** Sets the bandwidth for the Gaussian measurement filter.  
Range: Span/10 to full span (default: 3.6 MHz)

**Filter Parameter.** Sets the  $\alpha$ /BT value for the Gaussian measurement filter.  
Range: 0.0001 to 1.0 (default: 0.35)

**Frequency Recovery.** *For the Pulse-Pulse Phase and the Frequency Deviation measurements only.* Selects the frequency correction method.

- **1st.** Sets the correction value automatically, using the first pulse in the analysis range. The value is displayed in the **Frequency Offset** side key.
- **User.** Sets the correction value using the **Frequency Offset** side key described below.
- **Off. Default.** Disables the frequency correction.

**Frequency Offset.** Sets the frequency correction value when you select User in Frequency Recovery described above.

### Measurement Screen

The measurement waveform is displayed in the subview with the yellow lines (bold lines in Figure 3–49 on page 3–62) indicating the measurement points. Also, the pulse detection threshold (**MEAS SETUP** → **Detection Threshold**) is shown with the green arrow. These guidelines can be turned on or off by **VIEW: DEFINE** → **Guidelines**.

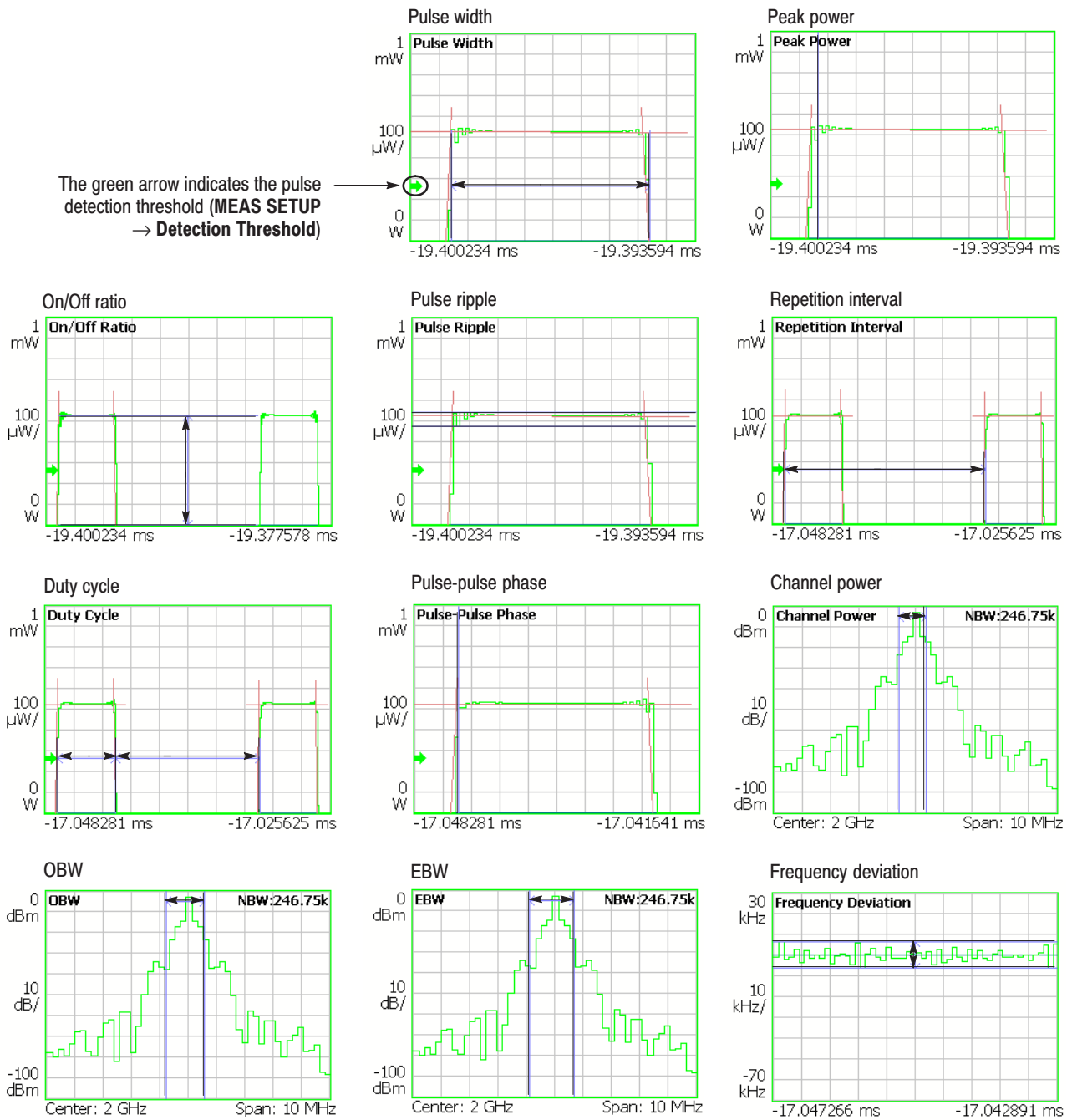


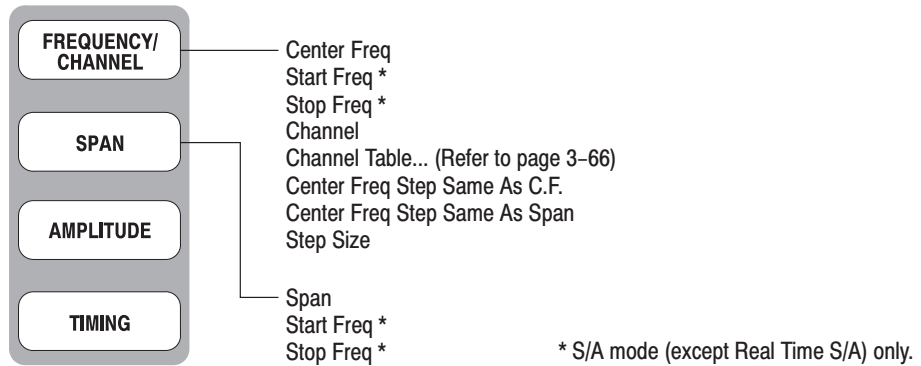
Figure 3-49: Waveform display in the subview



## Setting Frequency and Span

This section describes frequency and span, which are fundamental settings for observing the spectrum. These items are set using the general purpose knob and the numeric input keypad. You can also use the marker peak search function to set frequency.

## Frequency and Span Setting Menu



**FREQUENCY/CHANNEL** Sets frequency or channel.

**Center Freq.** Sets the center frequency. Numeric entry field.

Range: 0 Hz to 8 GHz

**Start Freq.** Sets the minimum value (left edge) of the horizontal axis. Numeric entry field.

Range: 0 Hz to 8 GHz

**Stop Freq.** Sets the maximum value (right edge) of the horizontal axis. Numeric entry field.

Range: 0 Hz to 8 GHz

---

**NOTE.** *Start Freq and Stop Freq are available when the measurement mode (Mode) is set to spectrum analysis (S/A except real-time).*

---

The values of Center Freq, Start Freq, Stop Freq, and Span are set in conjunction with each other. The relationship is described as  $(\text{Stop Freq}) - (\text{Start Freq}) = (\text{Span})$ . When one value is set, the other values are automatically changed accordingly.

**Channel.** Selects a channel number to set the center frequency from a channel table specified with the **Channel Table...** menu item.

**Channel Table...** Selects a communication standard to load the channel table. Select a channel number with the **Channel** menu item.

For using the channel tables, refer to page 3-66.



**Center Freq Step Same As C.F.** Sets the center frequency step size equal to the center frequency.

**Center Freq Step Same As Span.** Sets the center frequency step size equal to the span.

**Step Size.** Sets the step size (amount per press by which the up or down key (▲▼) changes the setting value) for setting frequency.

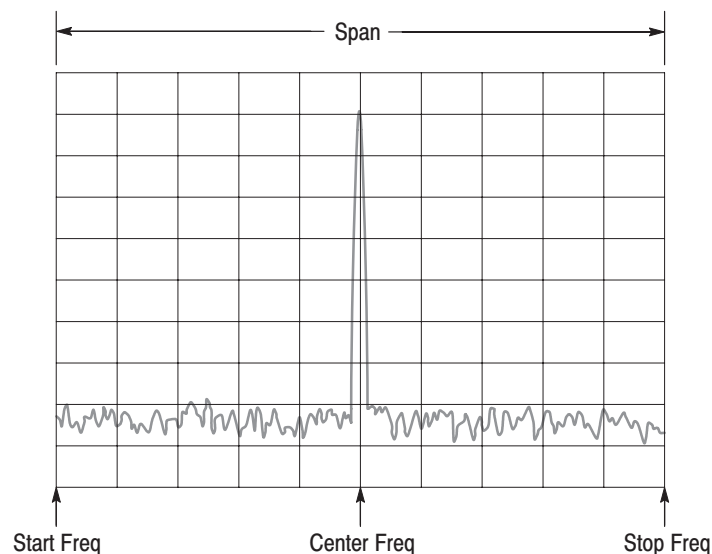
**SPAN** Controls span. Span and frequency settings are shown in Figure 3–50.

**Span.** Sets span. The available range depends on the measurement frequency band and mode as shown in Table 3–4 on page 3–68.

Turn the general purpose knob to set span in the specified sequence. In the S/A mode (except real-time), you can set an arbitrary span within the limit using the numeric keypad.

**Start Freq.** Same as *Start Freq* on page 3–64.

**Stop Freq.** Same as *Stop Freq* on page 3–64.



**Figure 3–50: Setting frequency and span**

## Using the Channel Table

The channel table contains channel numbers and the corresponding frequencies for a communication system. When you use W-CDMA standard signals, for example, you can set a center frequency by selecting a channel number from the W-CDMA table.

1. Press the **FREQUENCY/CHANNEL** key on the front panel.
2. Press the **Channel Table...** side key and select one of these items:

**None** selects no channel table.

You can select one of the following communication standards:

CDMA2000 EU PAMR400-FL	CDMA2000 EU PAMR400-RL
CDMA2000 EU PAMR800-FL	CDMA2000 EU PAMR800-RL
CDMA2000 GSM BAND 1-FL	CDMA2000 GSM BAND 1-RL
CDMA2000 GSM BAND 2-FL	CDMA2000 GSM BAND 2-RL
CDMA2000 IMT2000-FL	CDMA2000 IMT2000-RL
CDMA2000 JTACS BAND-FL	CDMA2000 JTACS BAND-RL
CDMA2000 KOREA PCS-FL	CDMA2000 KOREA PCS-RL
CDMA2000 N.A. 700MHz Cellular-FL	
CDMA2000 N.A. 700MHz Cellular-RL	
CDMA2000 N.A. Cellular-FL	CDMA2000 N.A. Cellular-RL
CDMA2000 N.A. PCS-FL	CDMA2000 N.A. PCS-RL
CDMA2000 NMT450 20k-FL	CDMA2000 NMT450 20k-RL
CDMA2000 NMT450 25k-FL	CDMA2000 NMT450 25k-RL
CDMA2000 SMR800-FL	CDMA2000 SMR800-RL
CDMA2000 TACS BAND-FL	CDMA2000 TACS BAND-RL
DCS1800-DL DCS1800-UL	GSM850-DL GSM850-UL
GSM900-DL GSM900-UL	IEEE802.11a IEEE802.11b/g
NMT450-DL NMT450-UL	PCS1900-DL PCS1900-UL
TD-SCDMA	W-CDMA-DL W-CDMA-UL

FL: Forward link; RL: Reverse link; UL: Uplink; DL: Downlink

3. Press the **Channel** side key and select a channel number.

For example, when selecting channel 10551 in the W-CDMA downlink table, the center frequency is automatically set to 2.1102 GHz.

## Using the Marker and Peak Search

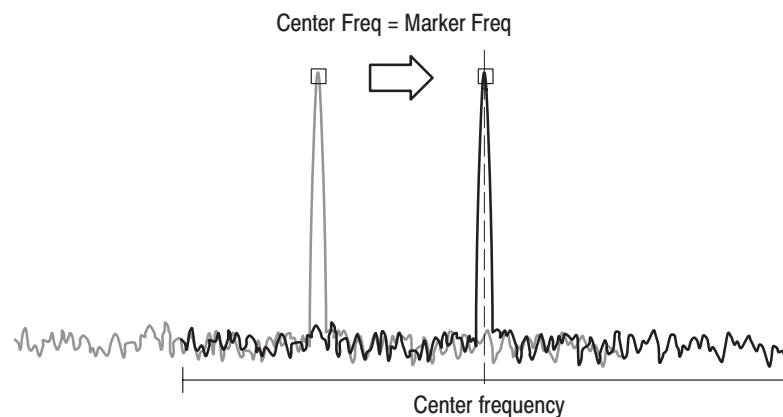
You can use the search function to position the marker on the spectrum peak and then set the center frequency to the frequency at the marker, as shown in Figure 3–51.

**In S/A Mode.** You can set the peak spectrum to the center frequency using the marker search functions when the measurement mode is S/A (spectrum analysis).

1. Display the spectrum on the screen.
2. Press the **PEAK** key on the front panel. The maximum peak spectrum is detected and the marker is moved to that point.

Use the arrow keys (◀▶ ▲ ▼) to move the marker to another peak.

3. Press the **MARKER** ➡ key and then the **Center Freq = Marker Freq** side key. The center frequency is set to the frequency at the marker position.



**Figure 3–51: Setting the center frequency using MARKER ➡**

The frequency set in this procedure may not take effect with all span settings. Refer to the *Setting Range* on page 3–68.

**In Demod and Time Modes.** The **MARKER** ➡ key is used to set the analysis range when the measurement mode is Demod or Time (modulation and time analyses). Refer to *Setting Analysis Range* on page 3–29 for details.

In the overview of spectrogram or the subview of spectrum, you can use the **Center Freq = Marker Freq** side key as in the S/A mode described above.

## Frequency Setting Range

Frequency bands are defined as shown in Table 3–4, based on the analyzer hardware architecture. The frequency band is switched automatically by a frequency setting. Span setting range depends on the frequency band and the measurement mode (S/A, Demod, or Time).

**Table 3–4: Frequency and span setting range**

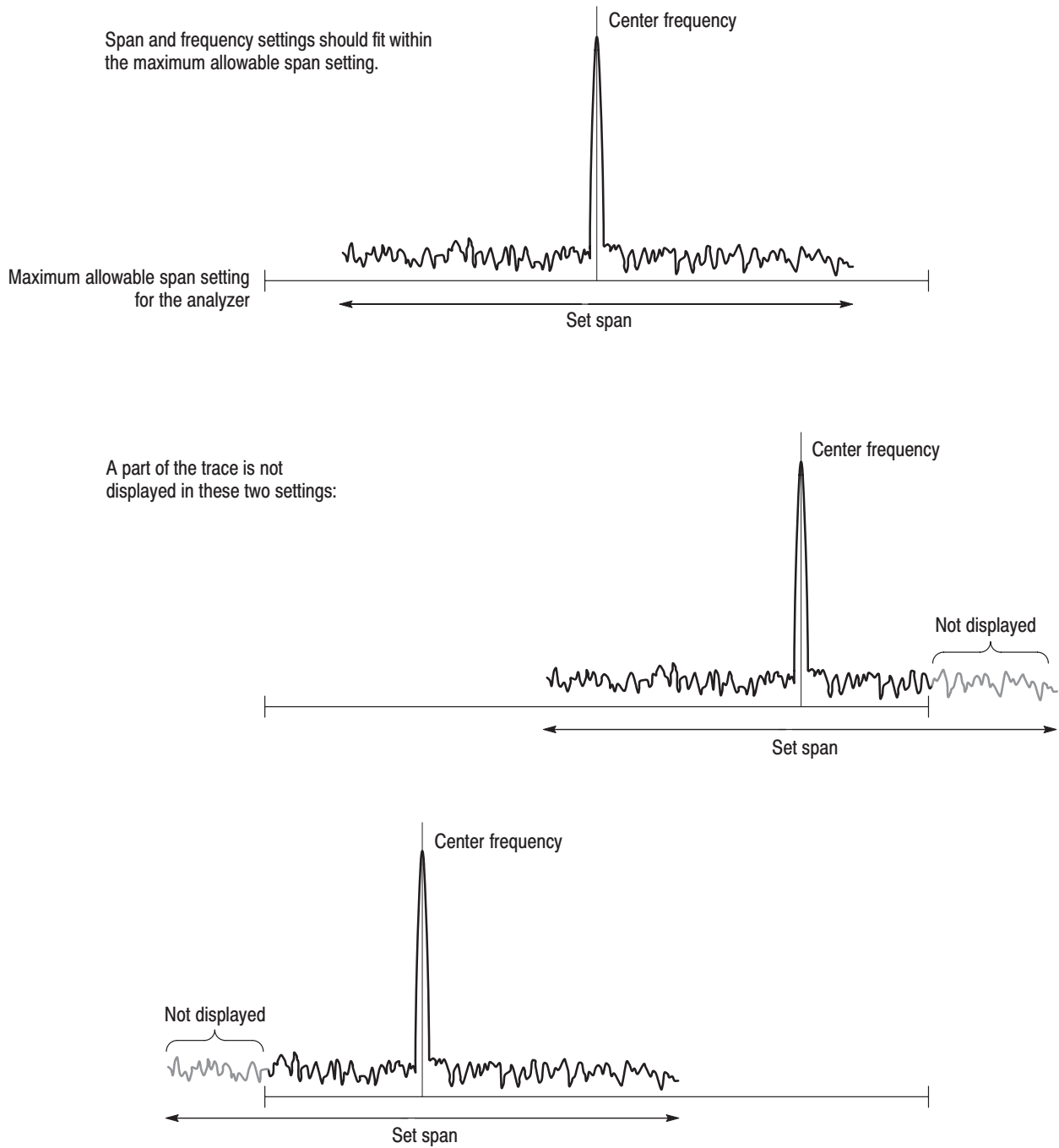
Measurement mode	Frequency band	Frequency range	Span setting range
S/A (except real-time)	Baseband (Option 05)	DC to 20 MHz	50 Hz to 20 MHz (1-1.2-1.5-2-2.5-3-4-5-6-8 sequence)
	RF (RSA2203A)	10 MHz to 3 GHz	50 Hz to 3 GHz (1-1.2-1.5-2-2.5-3-4-5-6-8 sequence)
	RF1 (RSA2208A)	10 MHz to 3.5 GHz	
	RF2 (RSA2208A)	3.5 to 6.5 GHz	
	RF3 (RSA2208A)	5 to 8 GHz	
Real Time S/A Demod, Time	Baseband (Option 05)	DC to 20 MHz	100 Hz to 20 MHz (1-2-5 sequence)
	RF (RSA2203A)	10 MHz to 3 GHz	100 Hz to 10 MHz (1-2-5 sequence)
	RF1 (RSA2208A)	10 MHz to 3.5 GHz	
	RF2 (RSA2208A)	3.5 to 6.5 GHz	
	RF3 (RSA2208A)	5 to 8 GHz	

In Demod and Time modes, the frequency and span settings must meet the following conditions:

$$\begin{aligned} &(\text{Center frequency}) + (\text{Span})/2 \\ &\leq \text{Upper limit of the frequency setting range (RF mode)} \\ &\leq 40 \text{ MHz (Baseband)} \end{aligned}$$

$$\begin{aligned} &(\text{Center frequency}) - (\text{Span})/2 \\ &\geq \text{Lower limit of the frequency setting range (RF mode)} \\ &\geq 0 \text{ Hz (Baseband)} \end{aligned}$$

When you enter an out-of-range value, the value is limited based on these conditions. In spectrum analyzer mode, the out-of-range values are allowed, but part of the trace may not be displayed because the analyzer cannot acquire that part of the waveform (see Figure 3–52).



**Figure 3–52: Relationship between the frequency and span settings**

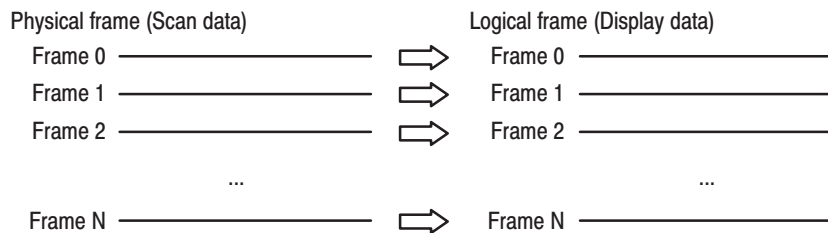
## Vector Span

The input signals are scanned in frame units (one frame = 1024 points). There are two frames: a physical frame to store scanned data and a logical frame to store display data, as illustrated in Figure 3–53.

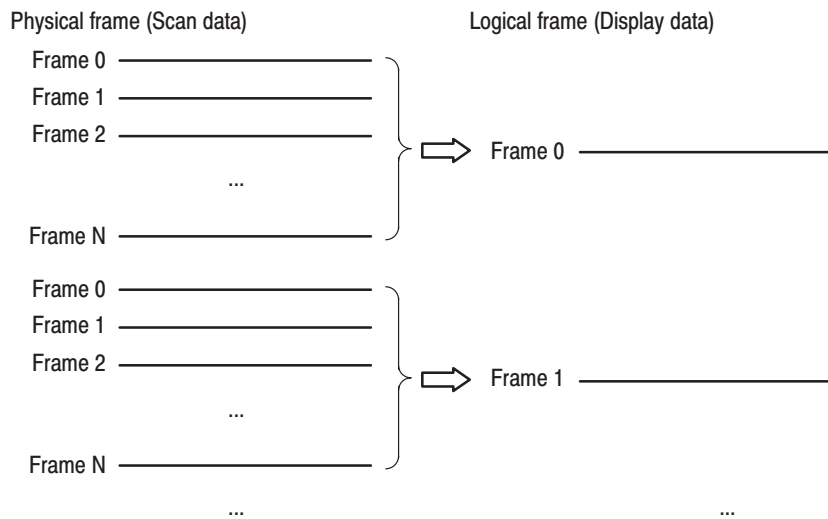
In the baseband, one logical frame is acquired at one scan regardless of the span setting. You can acquire one logical frame with one scan of a span setting below 10 MHz in the RF band. In larger spans, one logical frame is built up by acquiring data with multiple physical frames. For example, when the span is 20 MHz, one logical frame is composed from two (20 MHz/10 MHz) scans.

When the span is below 10 MHz in the baseband and RF band, one physical frame corresponds to one logical frame; this is referred to as Vector mode, and the span in vector mode is called the Vector span. In the other cases, one logical frame is composed of multiple physical frames, and this is called Scalar mode.

### Span ≤ 10 MHz: Vector mode



### Span > 10 MHz: Scalar mode



**Figure 3–53: Vector mode and scalar mode**

# Setting Amplitude

This section describes the fundamental amplitude settings for observing a spectrum. You can add correction to the waveform display by considering frequency characteristics of external devices such as antennas or preamplifiers.

## Amplitude Menu

Press the **AMPLITUDE** key to set amplitude. Figure 3–54 shows the Amplitude menu structure.

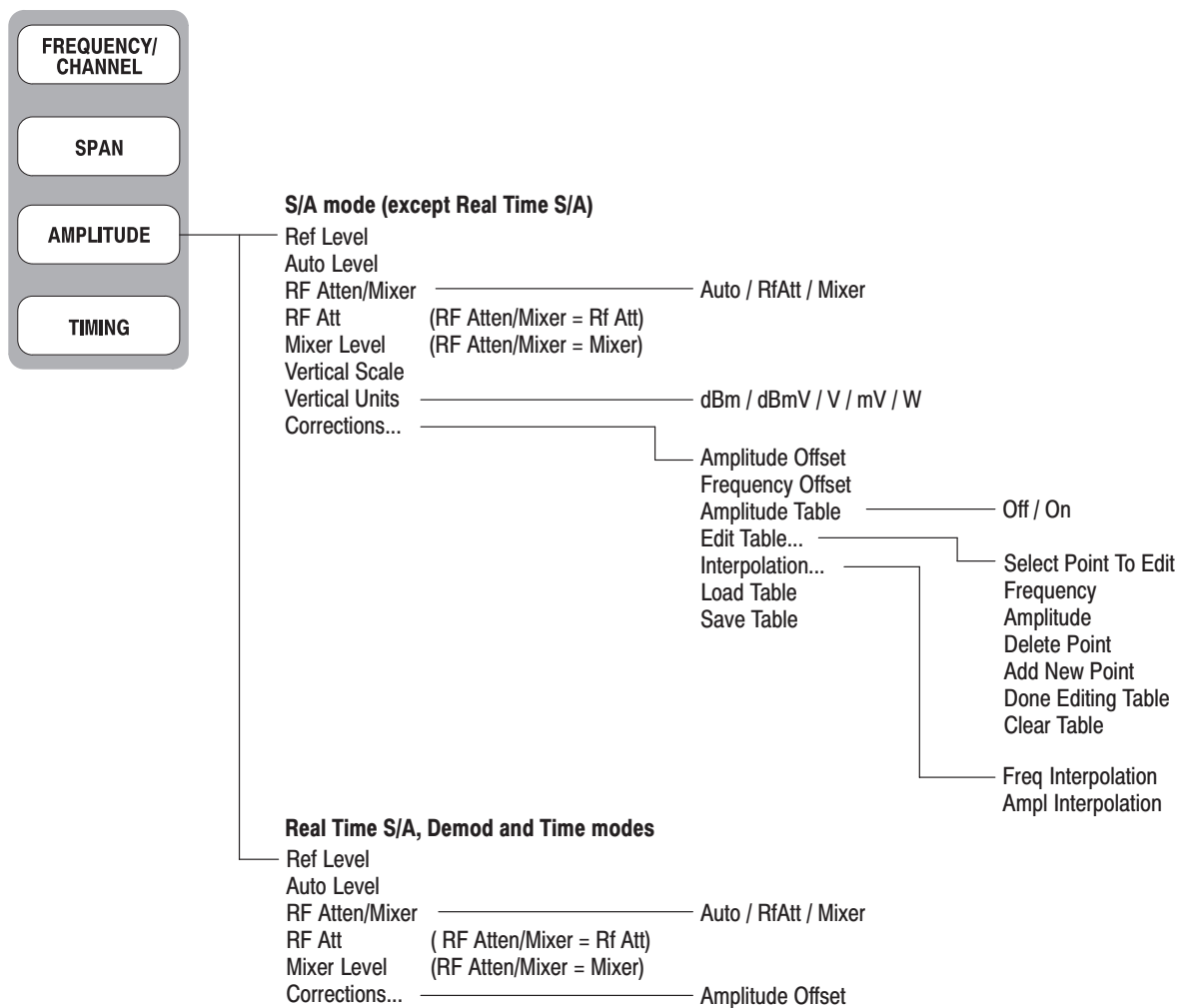


Figure 3–54: Amplitude menu structure

**AMPLITUDE** Sets the scale of the amplitude of the displayed waveform.

**Ref Level.** Sets the maximum (top) edge of the vertical axis. The available range depends on the measurement frequency band as shown in Table 3–5.

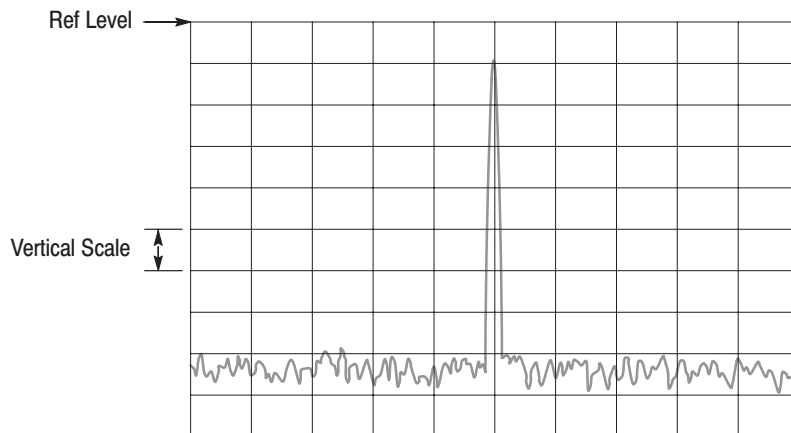
**Table 3–5: Reference level setting range**

Frequency band	Setting range
Baseband (Option 05)	-30 to +20 dBm (2 dB step)
RF (RSA2203A) / RF1 (RSA2208A)	-51 to +30 dBm (1 dB step)
RF2, 3 (RSA2208A)	-50 to +30 dBm (1 dB step)

**Auto Level.** Automatically adjusts reference level for the best system performance based on power measurement within the set span.

**NOTE.** An input signal within 10 MHz of the center frequency may cause Auto Level to choose the wrong reference level, even if the span setting does not make the signal appear on screen. To prevent nonlinear operation, the reference level may need to be adjusted manually.

Auto Level will force the analyzer to acquire new data, which will overwrite the existing data. To scale the existing displayed waveform, do not use Auto Level. Instead, use the View: Scale menu.



**Figure 3–55: Setting the amplitude**



**RF Atten/Mixer.** Input signals are attenuated through the attenuator and converted to IF signals through the mixer in the down-converter (refer to *Architecture* on page 1–6). The attenuation level and the mixer level are normally set automatically. Select **RF Att** or **Mixer** to manually set either parameter, if necessary. RF Atten/Mixer is unavailable in the baseband (DC to 20 MHz).

- **Auto.** Sets the mixer level and the RF attenuation level automatically.
- **RF Att.** Sets the RF attenuation level with **RF Att** described below.
- **Mixer.** Sets the mixer level using the **Mixer Level** setting.

---

**NOTE.** RF Atten/Mixer is set to Auto by default. In this setting, the mixer level is fixed to  $-25$  dBm.

---

**RF Att.** Changes the RF attenuation level when **RF Att** is selected in **RF Atten/Mixer** above.

**Table 3-6: RF attenuation level setting**

Frequency band	Attenuation level (dBm)
RF (RSA2203A) RF1 (RSA2208A)	0 to 50 (2 dB step)
RF2, 3 (RSA2208A)	0, 10, 20, 30, 40, or 50

Reducing the attenuation may increase the signal level compared to the noise floor, because the noise is generated after the RF attenuator.

**Mixer Level.** Selects the input level of the primary mixer when **Mixer** is selected in **RF Atten/Mixer**.

**Table 3-7: Mixer level setting**

Frequency band	Mixer level (dBm) <sup>1</sup>
RF (RSA2203A) RF1 (RSA2208A)	-5, -10, -15, -20, or -25
RF2, 3 (RSA2208A)	-5, -15, or -25

<sup>1</sup> **-25 dBm fixed when RF Atten/Mixer is set to Auto.**

Select the level according to measurement type. The default value is  $-25$  dBm. Use the default value in most cases. This level can be increased up to  $-5$  dBm when a high dynamic range is required for measurements such as the ACPR (Adjacent Channel Leakage Power Ratio) measurement.

---

**NOTE.** *As the mixer level increases, the distortion also increases.*

---

**Vertical Scale.** *S/A mode (except Real Time) only.* Sets the vertical scale (per division). The setting range depends on Vertical Units described below, as shown in Table 3–8.

**Table 3–8: Vertical scale setting range**

Vertical units	Scale setting <sup>1</sup>
dBm, dB $\mu$ V	1 to 10
V	223.6 n to 22 m
$\mu$ V	223.6 m to 22 k
W	100 p to 100 $\mu$

<sup>1</sup> **1-2-5 sequence with the general purpose knob.**  
**Arbitrary value with the numeric keypad.**

**Vertical Units.** Selects the unit of amplitude scale: dBm, dB $\mu$ V, V,  $\mu$ V, or W.

**Corrections...** Sets amplitude correction. Refer to page 3–76 for details of amplitude correction.

## Basic Setting Procedure

To set amplitude, follow these steps:

1. Press the **AMPLITUDE** key on the front panel.
2. Set the reference level using the **Ref Level** side key.
3. To best display the waveform automatically, press the **Auto Level** side key.
4. To set the attenuation level or the mixer level manually, use the **RF Atten/Mixer** side key to select **RF Att** or **Mixer**.

*When you select **RF Att**:*

Select the attenuation level with the **RF Att** side key.

*When you select **Mixer**:*

Select the first mixer input level using the **Mixer Level** side key.

5. *S/A mode (except Real Time) only.*  
 Use the **Vertical Scale** side key to set the vertical scale (per division).  
 Use the **Vertical Units** side key to select the unit.
6. To apply amplitude correction, press the **Corrections...** side key to set the parameters. Refer to *Amplitude Correction* on page 3–76 for details.

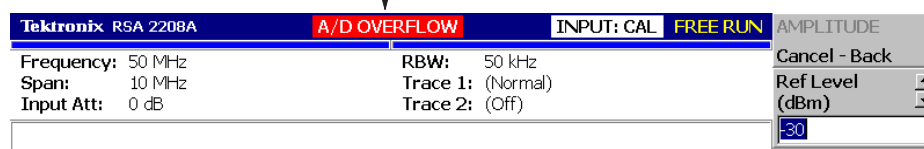
## Over-Voltage Input

Set the reference level (Ref Level) according to the input signal level. The default setting is 0 dBm. If the signal level gets too high or the reference level is set too low, over-voltage input may occur. If an over-voltage input occurs, the status indicator “A/D OVERFLOW” is displayed in the red box (see Figure 3–56).



**CAUTION.** *If a signal exceeding +30 dBm (1 W) is applied, it can damage the analyzer. Be sure to limit input signals to +30 dBm or below.*

When the input signal level is too high, A/D OVERFLOW is indicated in the red box.



**Figure 3–56: A/D overflow indicator**

**NOTE.** *If “A/D OVERFLOW” is displayed, it indicates that the A/D converter in the subsequent part of the downconverter inside this instrument is overloaded. In this case, data display is distorted and the measurement is not accurate.*

*If a signal larger than the reference level set value by 20 dB or more is applied continuously, however, the limiter of the IF amplifier in the downconverter is automatically activated to prevent large level signals from passing through the A/D converter. Even if a signal exceeding the reference level is applied, therefore, “A/D OVERFLOW” may not be displayed. Auto Leveling the signal can usually eliminate all overload conditions.*

*Take sufficient care about the input signal level.*

The overflow indicator is updated at every physical frame acquisition. When a high level signal is applied under a setting that uses multiple physical frames for one scan, “A/D OVERFLOW” may be displayed for a moment and then turned off immediately. When a single high-level signal is applied under a setting using one physical frame in one scan, the same phenomenon may be observed.

## Amplitude Correction

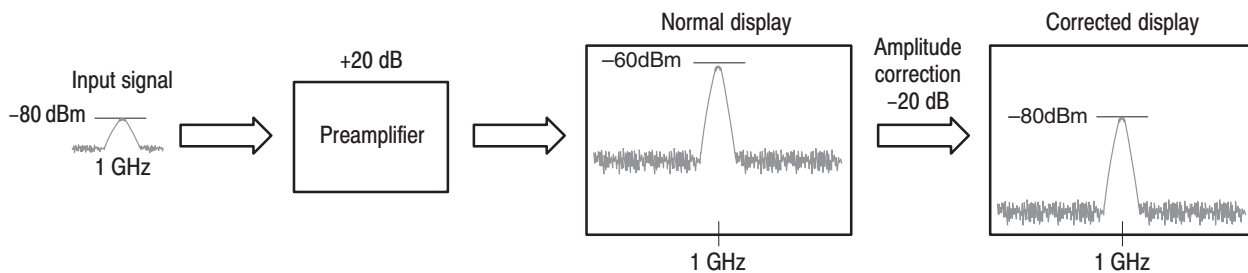
If an external device such as an antenna or preamplifier is connected to the analyzer, you can amplitude correct the waveform by considering the amplitude characteristics of the external device.

---

**NOTE.** The amplitude correction function is fully controlled only in the S/A mode (except real-time mode). In the other modes (Real Time S/A, Demod, and Time), amplitude offset control is available. Refer to page 3–83 for setting the offset.

---

Figure 3–57 shows the concept of amplitude correction. In this example, a signal with  $-80$  dBm is sent to a preamplifier with a gain of  $+20$  dB around  $1$  GHz. In the normal display, without any amplitude correction, the signal peak becomes  $-80+20 = -60$  dBm. If amplitude correction is performed, the peak becomes  $-60-20 = -80$  dBm to obtain the original peak value of the input signal.



**Figure 3–57: The amplitude correction concept**

**Amplitude Correction  
Menu**

Press **AMPLITUDE** → **Corrections...** to set the correction parameters. The correction menu has the following controls:

**Amplitude Offset.** Sets the amplitude offset. The amplitude of an entire waveform decreases by the offset value.

---

**NOTE.** *The following Corrections menu items are available in the S/A (spectrum analysis) mode except Real Time S/A.*

---

**Frequency Offset.** Sets the frequency offset. The effective correction range of the amplitude correction table shifts by the offset value.

**Amplitude Table.** Enables or disables amplitude correction. Select On to enable the correction.

**Edit Table...** Creates a correction table. Input pairs of frequency and amplitude correction value.

- **Select Point To Edit.** Selects a row to be edited.
- **Frequency.** Enters the frequency of a correction point.
- **Amplitude.** Enters an amplitude correction value for the specified frequency.
- **Delete Point.** Deletes the selected row.
- **Add New Point.** Adds a row with the values in the previous row copied as initial values.
- **Done Editing Table.** Confirms the input and adds a new row.
- **Clear Table.** Deletes the correction data from the memory.

**Interpolation...** Selects the horizontal and the vertical scale for interpolating correction data.

- **Freq Interpolation.** Selects the horizontal scale for interpolating correction data: Linear or Logarithmic.
- **Ampl Interpolation.** Selects the vertical scale for interpolating correction data: Linear or dB.

**Load Table.** Reads an amplitude correction table from a file.

**Save Table.** Writes a created correction table to a file.

### Amplitude Correction File

Before performing amplitude correction, you must describe the frequency characteristics of the external device in an amplitude correction file (\*.cor).

You can use word processing software to create the file on a computer and then use a disk or network to load the file into the analyzer. Alternatively, you can create correction data on the analyzer screen.

The rules for creating an amplitude correction file are given on page 3–79 and the procedures are given on page 3–80.

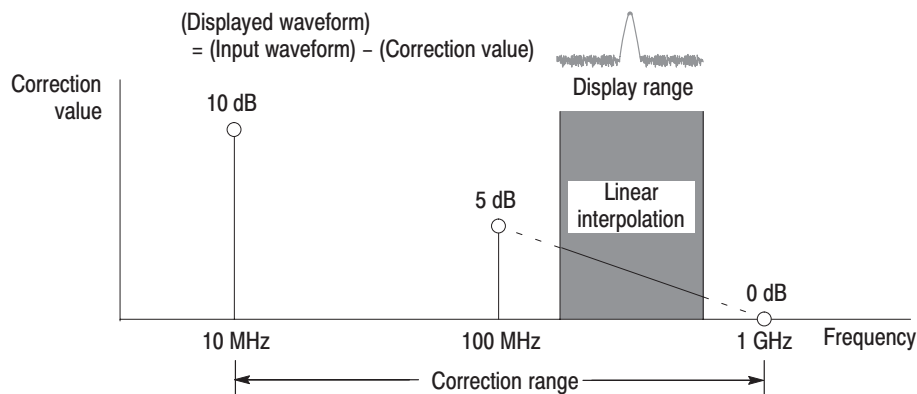
**File Format.** A correction file contains amplitude correction values at each frequency, in the following format:

```
<Frequency 1> = <Amplitude correction value 1>
<Frequency 2> = <Amplitude correction value 2>
<Frequency 3> = <Amplitude correction value 3>
...
```

*Example:* The following amplitude correction file has correction data for three points:

Correction data:	Correction file description:
10 dB at 10 MHz	10M=10
5 dB at 100 MHz	100M=5
0 dB at 1 GHz	1G=0

In this example, only the data from 10MHz to 1GHz is corrected (see Figure 3–58). The correction value in the display range is obtained using linear interpolation between input points. A waveform obtained by subtracting the correction value from the input waveform is displayed.



**Figure 3-58: Amplitude correction example**

Linear or Logarithmic (Log/dB) interpolation can be selected using the following menus:

■ **AMPLITUDE** → **Corrections...** → **Interpolation...** → **Freq Interpolation**

**Lin.** Linear interpolation of correction values is performed on the frequency axis using a linear scale.

**Log.** Linear interpolation of correction values is performed on the frequency axis using a logarithmic scale.

■ **AMPLITUDE** → **Corrections...** → **Interpolation...** → **Ampl Interpolation**

**Lin.** Linear interpolation of correction values is performed on the amplitude axis using a linear scale.

**dB.** Linear interpolation of correction values is performed on the amplitude axis using a logarithmic scale.

**Rules for Creating an Amplitude Correction File.**

- Create the file as a text file and save it with the extension “.cor”.
- The maximum number of input lines is 3000.
- The order of correction data input is unimportant because the file is sorted when it loads. However, it may be easier to follow if you enter data in the order of ascending frequency.
- Numeric values are described without the unit of frequency or amplitude (Hz, dB, W, etc.). For example, 5 MHz frequency is expressed as 5M.
- Frequency can be expressed as a floating point number or with the SI unit (k, M, or G). For example, the following lines show three different ways to express the same value:

```
1000, 1E+3, 1k
1230000, 1.23E+6, 1.23M
1000000000, 1.0E+9, 1.0G
```

- Amplitude is expressed as a decimal number or integer (such as 1.23 or 10).
- Do not use a space in a numeric value; however, you can space before and after “=”.

*Correct:* 10M = 10 (A space is inserted before and after “=”.)

*Incorrect:* 10 M=10 (A space is inserted between “10” and “M”.)

**Creating an Amplitude Correction File on a Computer.** Use word processing software on a computer to create a text file with the extension “.cor”.

Be sure to use the correct file format (refer to *File Format* on page 3–58) and follow the *Rules for Creating an Amplitude Correction File* on page 3–79.

For information about performing amplitude correction, refer to page 3–84.

**Creating Correction Data on the Analyzer Screen.** The procedure for entering new correction data or modifying existing data on the screen is as follows. Refer also to *Rules for Creating an Amplitude Correction File* on page 3–79.

1. Press the **AMPLITUDE** key on the front panel.
2. Press the **Corrections...** side key.
3. *To edit an existing file:* Refer to page 3–157 for file handling.
  - a. Press the **Load Table** side key to load the file.
  - b. Press the **Edit Table...** side key.
4. *To enter new data:* See Figure 3–59.
  - a. Press the **Frequency** side key and enter the frequency of a correction point.
  - b. Press the **Amplitude** side key and enter the amplitude correction value at the correction point.
  - c. Press the **Add New Point** side key.

A new row is added, containing the same frequency and amplitude correction values as the previous row. Modify the values appropriately.

---

**NOTE.** *If you set the same frequency as the previous row, the amplitude correction value in the previous row will be overwritten the next time you press the Add New Point side key.*

*It is not necessary to enter correction data in order by frequency. The rows are automatically reordered in ascending order of frequency.*

---

- d. Repeat step c to enter the frequency and amplitude correction values for all points.
- e. Press the **Done Editing Table** side key.

The input is accepted and a new row is added.



5. To add correction data:

- a. Press the **Select Point To Edit** side key and turn the general purpose knob to move the cursor to the last row (empty) in the table.
- b. Perform step 4 to enter the frequency and amplitude correction values.

The screenshot shows the Tektronix RSA 2208A interface. At the top, it displays 'Tektronix RSA 2208A', the date and time '03/08/11 14:52:13', and 'FREE RUN'. Below this, there are settings for Frequency (1.5 GHz), Span (10 MHz), Input Att (20 dB), RBW (50 kHz), Trace 1 (Normal), and Trace 2 (Off). A table with two columns, 'Frequency (Hz)' and 'Amplitude (dB)', contains four rows. The first three rows have data: (1, 10M, 10), (2, 20M, 12), and (3, 30M, 14). The fourth row is empty and highlighted with a blue background. Arrows point from the labels 'Frequency' and 'Amplitude correction value' to the columns of this row. To the right of the table is a vertical 'Edit Table' menu with the following options: 'Cancel - Back', 'Select Point To Edit (4)', 'Frequency (Hz)' (with a dropdown arrow and a text input field containing '0'), 'Amplitude' (with a text input field containing '0'), 'Delete Point', 'Add New Point', 'Done Editing Table', and 'Clear Table'. Arrows point from text labels to each of these menu items. At the bottom of the screen, a status bar shows 'Spectrum Analyzer: Measurement Off' and 'Frequency (Hz): 0'.

	Frequency (Hz)	Amplitude (dB)
1	10M	10
2	20M	12
3	30M	14
4		

**Edit Table**

- Cancel - Back
- Select Point To Edit (4) ← **Select Point To Edit**  
Selects a line.
- Frequency (Hz) ← **Frequency**  
Inputs frequency of the point.
- Amplitude ← **Amplitude**  
Inputs correction value.
- Delete Point ← **Delete Point**  
Deletes a line.
- Add New Point ← **Add New Point**  
Deletes all data in the table
- Done Editing Table ← **Done Editing Table**  
Registers the input values and adds a line
- Clear Table ← **Clear Table**  
Deletes all data in the table

Figure 3-59: Amplitude correction data input

6. To modify input data: Press the **Select Point To Edit** side key and turn the general purpose knob to move the cursor to the row to be modified. Use the following side keys as needed:
  - To modify a frequency, use the **Frequency** side key.
  - To modify an amplitude, use the **Amplitude** side key.
  - To delete a row, press the **Delete Point** side key.
  - To delete all data in the table, press the **Clear Table** side key.
7. Repeat steps 5 through 6 as needed.

- 8.** When you have finished the data input, save the file as follows:
  - a.** Press the **AMPLITUDE** key on the front panel.
  - b.** Press the **Corrections...** side key.
  - c.** Press the **Save Table** side key to specify the save file.  
Refer to page 3–157 for file handling.

For information about performing amplitude correction, refer to page 3–84.

## Setting the Offset

The amplitude correction function includes amplitude and frequency offset.

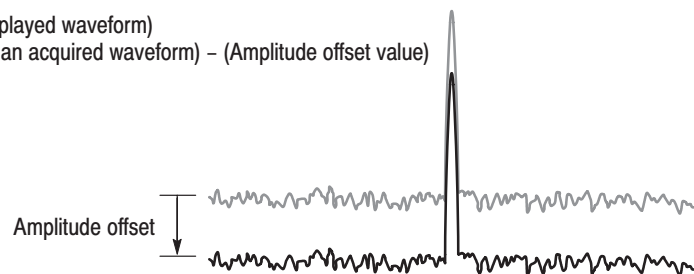
**NOTE.** The amplitude offset is available in all the measurement modes of S/A, Demod, and Time.

**Amplitude Offset.** Subtracts the specified offset from the original amplitude (see Figure 3–60). The offset value is set using the menu item **AMPLITUDE** → **Corrections...** → **Amplitude Offset**.

The operation varies slightly between the measurement modes as follows:

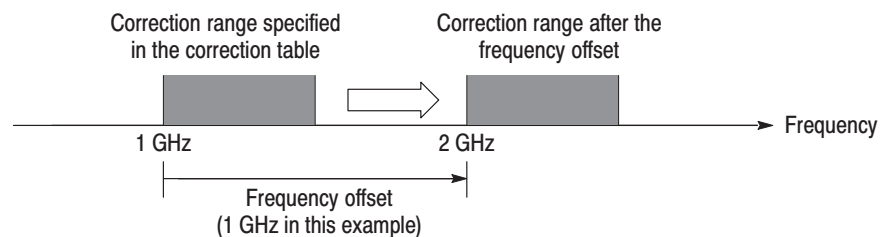
- *In the S/A mode (except real-time mode):* The amplitude offset is effective whenever the amplitude correction is turned on (**AMPLITUDE** → **Corrections...** → **Amplitude Table** → **On**) even if the table is not set.
- *In the other modes (Real Time S/A, Demod, and Time):* The amplitude offset is always effective. The default value is zero. If you set the offset to a non-zero value, a waveform shifts vertically as shown in Figure 3–60.

(Amplitude of a displayed waveform)  
= (Amplitude of an acquired waveform) – (Amplitude offset value)



**Figure 3–60: Amplitude offset**

**Frequency Offset.** Shifts the correction range by the specified offset with the same correction table (see Figure 3–61). The offset value is set using the **AMPLITUDE** → **Corrections...** → **Frequency Offset** menu item.



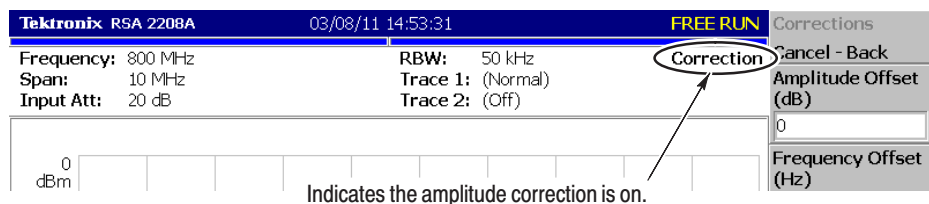
**Figure 3–61: Frequency offset**

### Performing Amplitude Correction

Load an amplitude correction file and acquire input signals:

1. Press the **AMPLITUDE** key on the front panel.
2. Press the **Corrections...** side key.
3. Do either of these two steps:
  - Press the **Edit Table...** side key to create an amplitude correction file. Refer to page 3–78 for creating the correction file.
  - Press the **Load Table** side key to specify an amplitude correction file. Refer to page 3–157 for file operation.
4. Press the **Amplitude Offset** side key to set the amplitude offset, if necessary.
5. Press the **Frequency Offset** side key to set the frequency offset, if necessary.
6. Press the **Interpolation...** side key to select scaling for the interpolation:
  - a. Press the **Freq Interpolation** side key to select the scale for frequency interpolation: Lin (linear) or Log (logarithmic).
  - b. Press the **Ampl Interpolation** side key to select the scale for amplitude interpolation: Lin (linear) or dB (logarithmic).
7. Press the **Amplitude Table** side key to select **On**. The amplitude correction is now applied to the waveform.

The amplitude correction is applied to the acquired data and the corrected waveform is shown. When the amplitude correction is turned on, “Correction” is displayed in the setup display area at the upper right of the screen, as shown in Figure 3–62.



**Figure 3–62: Amplitude correction setup display**

### Erasing Correction Data

The analyzer automatically saves the correction data in use when it is powered down. The data will be erased when you press these keys:

- **AMPLITUDE** → **Corrections...** → **Edit Table...** → **Clear Table**
- **PRESET**

# Setting Timing Parameters

You can adjust the length of various time parameters and the relationship between them in the Real Time S/A, Demod, and Time modes using the Timing menu.

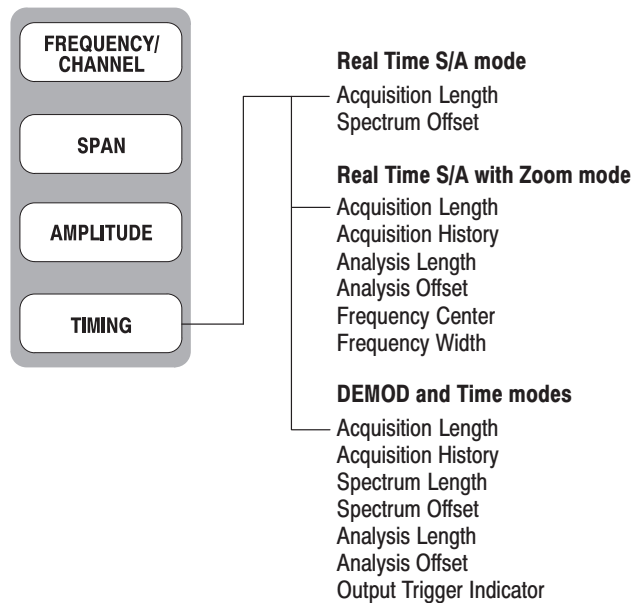
---

**NOTE.** *The Timing menu is not available in the S/A mode (except Real Time S/A).*

---

## Timing Menu

Figure 3–63 shows the Timing menu structure.



**Figure 3–63: Timing menu structure**

**Time Parameters in Demod and Time Modes**

The Timing menu in Demod (modulation analysis) and Time (time analysis) modes contains the following items:

**Acquisition Length.** Sets the time length to acquire one block (= M frames). The acquisition length is calculated using this equation:

$$(\text{One block acquisition length}) = M \times (\text{One frame acquisition length})$$

where M is the number of frames in a block.

One frame acquisition length is determined by span internally. For details, refer to Table A-10 on page A-8 in *Appendix A: Specifications*.

**Acquisition History.** Specifies the number of the block to display and analyze. The latest block is number zero. Older blocks have larger negative numbers. In most cases the analyzer retains previous acquisitions. You can view previous acquisitions by selecting the acquisition history by block number.

**Spectrum Length.** Displays the time length for FFT processing of the spectrum displayed in the subview. It is equivalent to one frame acquisition length determined by Span, RBW, and FFT points setting.

**Spectrum Offset.** Sets the beginning of Spectrum Length with respect to the trigger output point.

**Analysis Length.** Sets the time length of the analysis range in the block specified by Acquisition History.

**Analysis Offset.** Sets the beginning of Analysis Length with respect to the trigger output point.

**Output Trigger Indicator.** Determines whether to display the output trigger indicator (“O”) on the overview. Refer to *Trigger Point Indicator* on page 3-101.

For procedures to set these parameters, refer to *Setting Analysis Range for the Main View* on page 3-29 and *Setting FFT Processing Range for the Subview* on page 3-31.

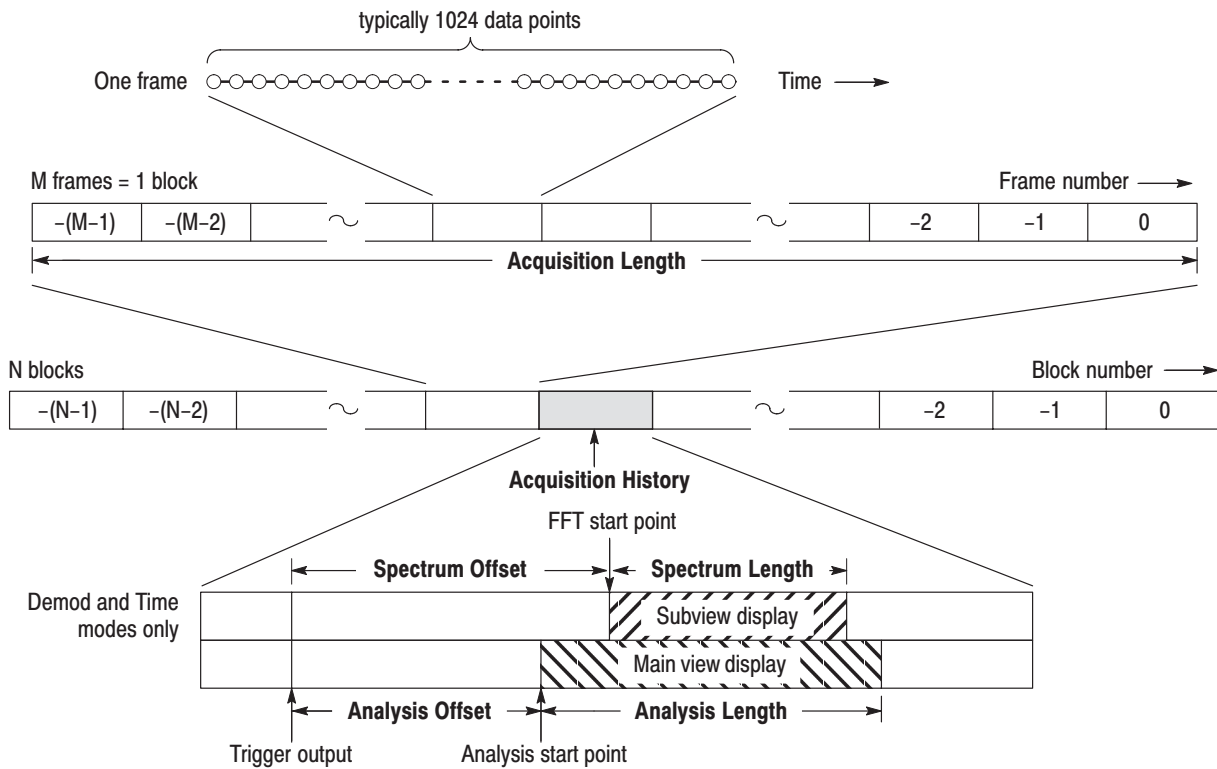


Figure 3-64: Timing parameters

**Timing Parameters in Real Time S/A Mode**

The Timing menu in the Real Time S/A (real-time spectrum analysis) mode contains the following items:

**Acquisition Length.** Same as in the Demod and Time modes.

**Spectrum Offset.** Specifies the number of the frame in the spectrogram to display the spectrum. The latest frame is number zero. Older frames have larger negative numbers.

**Timing Parameters in Real Time S/A with Zoom Mode**

The Timing menu in the Real Time S/A with Zoom mode contains the following items (see Figure 3–65):

**Acquisition Length.** Same as in the Demod and Time modes.

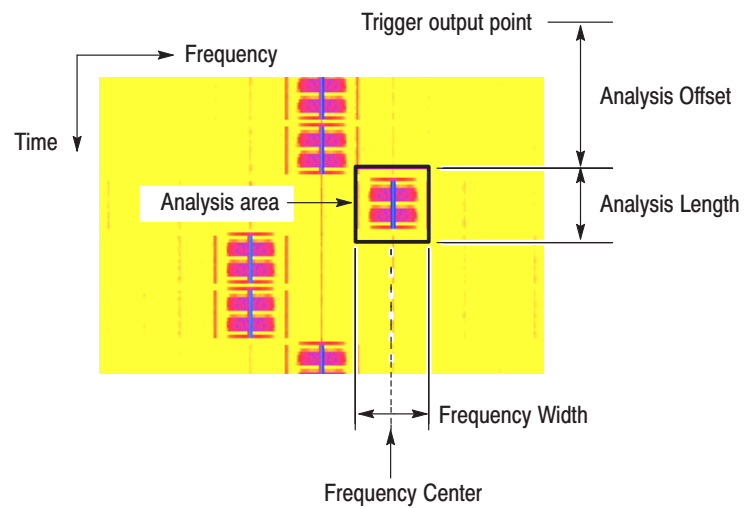
**Acquisition History.** Same as in the Demod and Time modes.

**Analysis Length.** Same as in the Demod and Time modes.

**Analysis Offset.** Same as in the Demod and Time modes.

**Frequency Center.** Sets the frequency of the center of analysis area.

**Frequency Width.** Sets the frequency width of the analysis area.

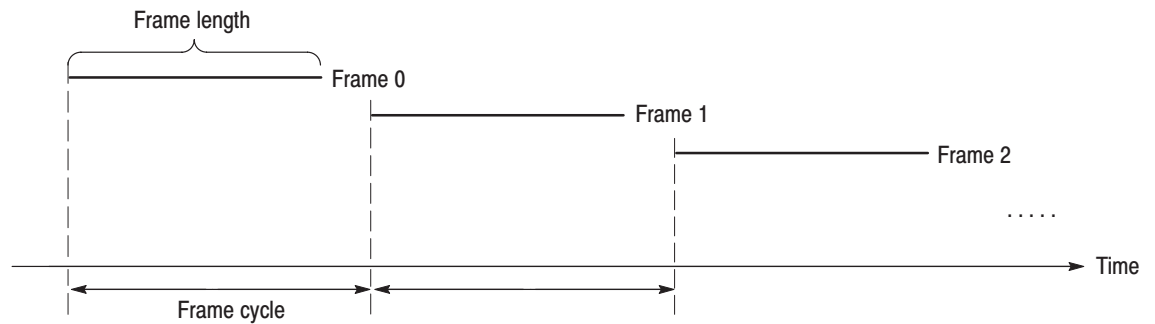


**Figure 3–65: Timing parameters in the zoom mode**



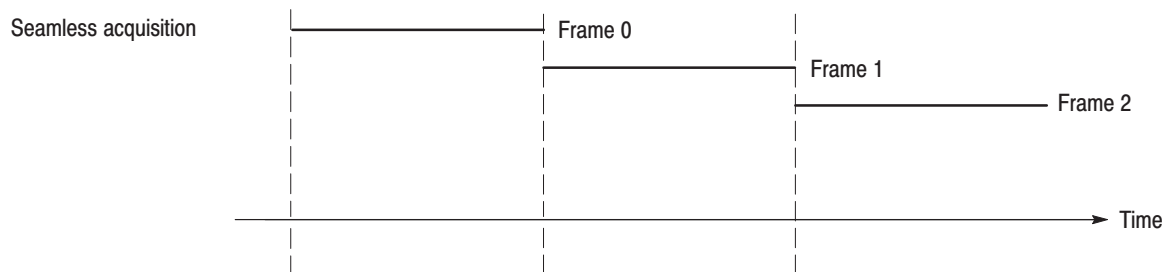
## Seamless Acquisition

The frame data is acquired every designated time. The interval between one acquisition and another is called a “frame cycle,” as shown in Figure 3–66.



**Figure 3–66: Frame cycle**

If the frame cycle is longer than the frame length, time gaps appear between frames. The shorter the frame cycle, the more precisely you can observe the spectrum waveform variation in time. You can acquire frames without gaps when the span setting is below 10 MHz. Acquiring frame data without a gap is called Seamless Acquisition. See Figure 3–67.



**Figure 3–67: Seamless acquisition**

When the span is set greater than 10 MHz, one display frame is reproduced from multiple acquired frames and the frame cycle becomes meaningless. Refer to *Vector Span* on page 3–70 for details.



# Trigger

Triggers determine when the analyzer stops acquiring an input signal and displays measurement results. To properly acquire data that you want to measure, you need to set up the trigger conditions. This section describes the following trigger parameters:

- **Mode:** Selects free run or triggered acquisition.
- **Repeat:** Determines whether to acquire data continuously or singly.
- **Source:** Selects a trigger signal source.
- **Level:** Sets a trigger level.
- **Slope:** Selects the rising or falling edge of a trigger signal.
- **Position:** Specifies a trigger position.

A “T” mark (with “O” optionally) indicating a trigger point is displayed on the overview in the Demod and Time modes. Refer to page 3–101 for information about displaying the trigger point.

## Trigger Menu

Use the Trigger menu to set trigger conditions. Press the **TRIG** key on the front panel and set the parameters using the following menu items.

---

**NOTE.** Except for the Repeat menu item, the Trigger menu is available when the measurement mode is set to Real Time S/A, Demod, or Time.

---

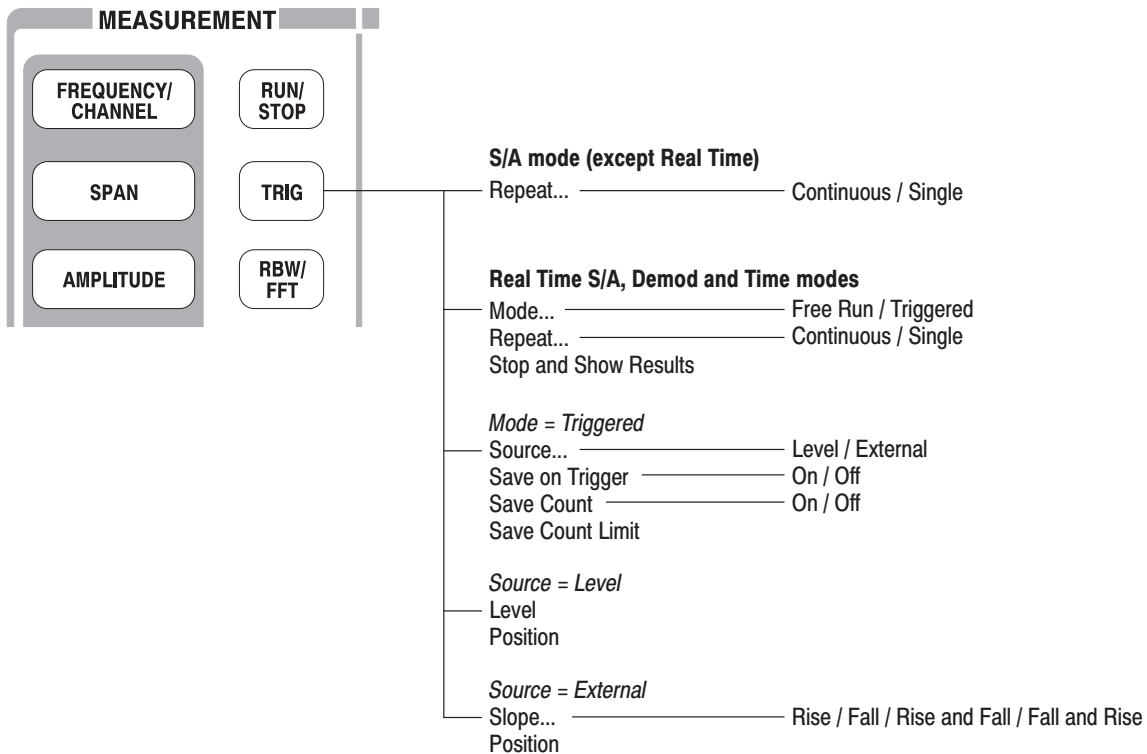


Figure 3-68: Trigger menu structure

**Mode...** Selects the trigger mode. The trigger mode determines whether to acquire data with or without triggering.

- **Free Run.** Acquires and displays the waveform without triggering. Press the **RUN/STOP** key to start data acquisition. To stop the acquisition, press the **RUN/STOP** key again.
- **Triggered.** Set the trigger conditions (level, slope, and position) before starting data acquisition by pressing the **RUN/STOP** key. When the trigger occurs, data is acquired and displayed. To stop data acquisition when the trigger does not occur, press the **RUN/STOP** key again.

**Repeat...** Selects whether to acquire data continuously or singly.

- **Continuous.** Repeatedly acquires and displays the waveform. Acquisition data will be overwritten while waiting for a new trigger event. Use the Single setting if you will need to examine or reanalyze the measurement results.
- **Single.** Acquires and displays one waveform. After the first waveform display, you must press RUN/STOP to acquire and display each waveform.

Table 3–9 shows the acquisition method with the trigger and repeat modes. The concept is illustrated in Figure 3–71 on page 3–96.

**Table 3–9: How to acquire a waveform**

Trigger mode (TRIG → Mode)	Repeat mode (TRIG → Repeat)	Description
Free run	Continuous	Press RUN/STOP to acquire data repeatedly. Press this key again to stop acquisition.
	Single	Press RUN/STOP to acquire one waveform.
Triggered	Continuous	Press RUN/STOP to acquire data every trigger event.
	Single	Press RUN/STOP to acquire one waveform every trigger event.

**Stop and Show Results.** Stops data acquisition and shows measurement results. Instead of the **RUN/STOP** key, you can stop data acquisition by pressing the **Stop and Show Results** side key when the measurement mode is Real Time S/A, Demod, or Time. However, there is the following difference in function:

- Pressing the **RUN/STOP** key to stop data acquisition: The block data acquired at the moment of pressing the key is discarded and the measurement results are shown for the previous block of data.
- Pressing **TRIG → Stop and Show Results** to stop data acquisition: Shows measurement results even for the block of data acquired at the moment of pressing the side key, which might not fill a whole block.

In either case, press **RUN/STOP** again to restart acquisition.

**Source.** Selects a trigger source when the trigger mode is Triggered.

- **Level (Full BW).** *Default.* Uses the internal IF (intermediate frequency) signal of the analyzer as the trigger source. The Trigger Level and Position can be set. Refer to page 3–98 for information about the IF trigger.
- **External.** Uses the external signal input from the TRIG IN connector on the rear panel as the trigger source. You can set the trigger level, slope, and position. For the specification of the external trigger, refer to page A–10.

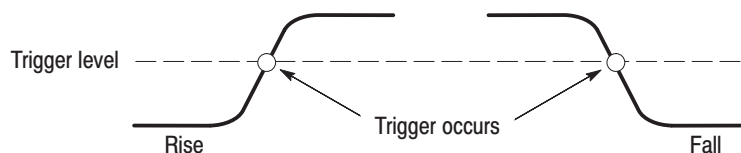
**Level.** Sets the trigger level. Available when the trigger mode is set to Triggered and the source is Level.

Range: 1 to 100% in 1% step (100% means full scale of the internal A/D output)

For the external trigger, the trigger level is fixed internally. For specifications of the external trigger, refer to page A–10.

**Slope.** Selects the trigger slope when the trigger mode is Triggered and the trigger source is External.

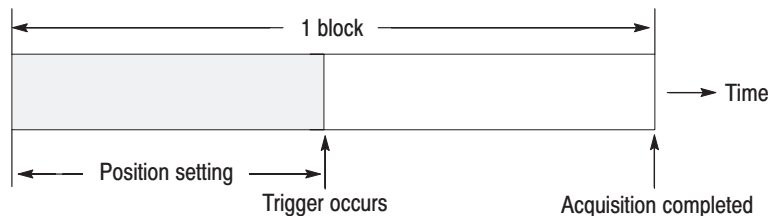
- **Rise.** The trigger occurs at the rising edge of the trigger signal.
- **Fall.** The trigger occurs at the falling edge of the trigger signal.
- **Rise and Fall.** The trigger occurs at the rising edge of the trigger signal to acquire the first block, and at the falling edge to acquire the next block. The rising and falling edges alternate at each block acquisition.
- **Fall and Rise.** The trigger occurs at the falling edge of the trigger signal to acquire the first block, and at the rising edge to acquire the next block. The rising and falling edges alternate at each block acquisition.



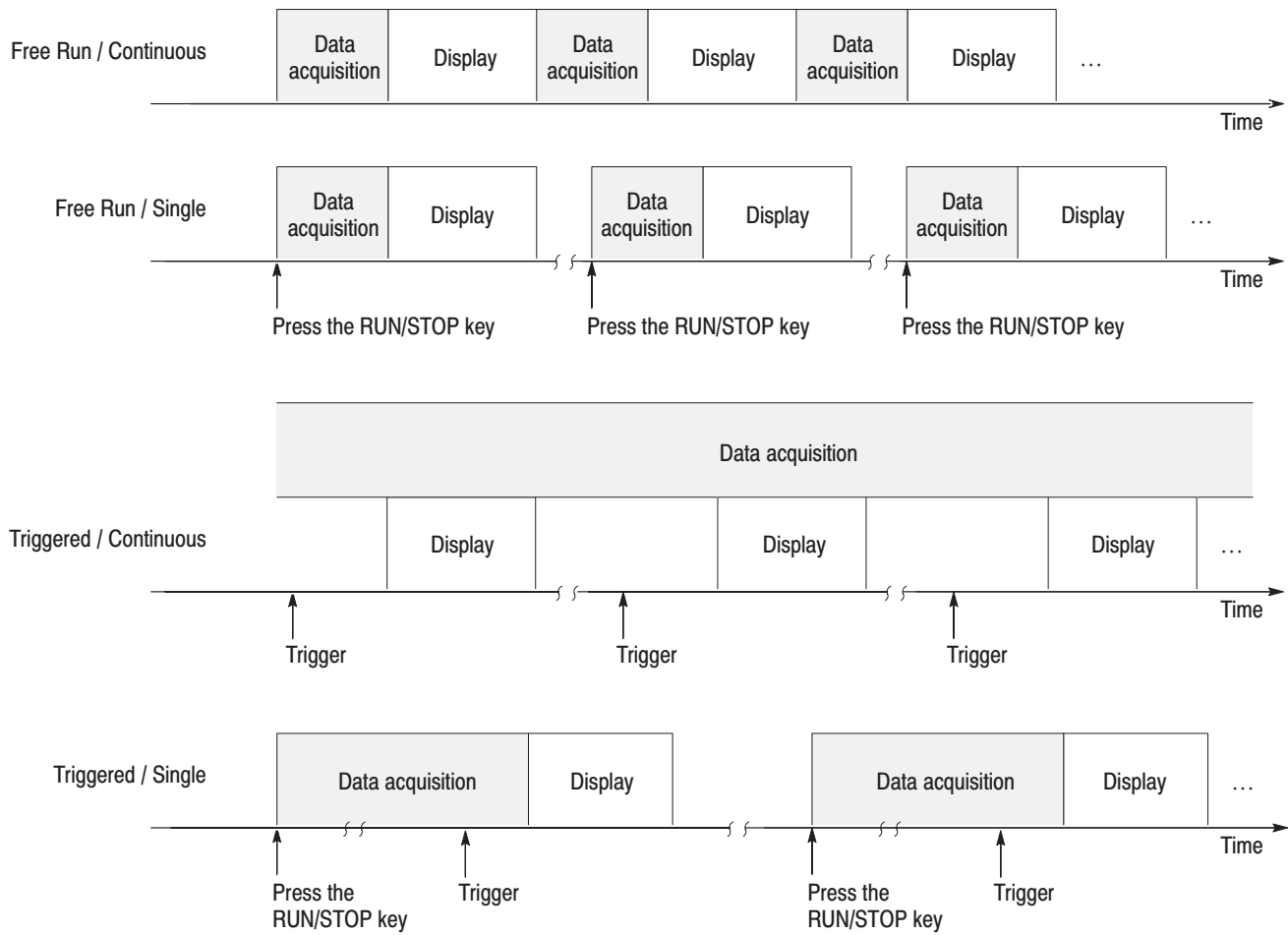
**Figure 3-69: Trigger level and slope**

**Position.** Available when the trigger mode is set to Triggered. Specifies the position of the trigger in a block as a percentage of all the frames in the block. For example, if you set the trigger position to 50%, the trigger occurs at the center of the block, as shown in Figure 3-70.

Range: 0 to 100% in 1% step.



**Figure 3-70: Trigger position**



**Figure 3-71: Acquiring and displaying data by Trigger and Repeat modes**



## Data Saving on Trigger

A Save-on-Trigger function is provided to save one block of input data to the IQT file each time a trigger occurs. This function is enabled when the trigger mode is set to Triggered. For details of file operations, refer to page 3–157.

The file name and location are as follows:

- File name: yyyyymmdd–hhmmss–“ticks”.IQT

Where

yyyy is the year, mm the month, and dd the date.

hh is the hour, mm the minutes, and ss the seconds.

“ticks” is the time stamp of the final frame.

(Refer to *unsigned long ticks* on page 3–174)

Example: 20050721–140120–0000154761.IQT

- Directory:  
C:\Documents and Settings\

Use the following Trigger menu items to control the Save-on-Trigger function:

**Save On Trigger.** Enables and disables the Save-on-Trigger function.

- **On.** Enables the Save-on-Trigger function
- **Off. Default.** Disables the Save-on-Trigger function

**Save Count.** Selects whether or not to set a limit on the number of times that data is saved.

- **On. Default.** When the number of data save operations reaches the Save Count Limit indicated below, data saving is halted.
- **Off.** No limit on data save operations is set. In this case, data saving is halted using the **RUN/STOP** key on the front panel or the GPIB command.

---

**NOTE.** When the internal hard disk becomes full, data saving is halted and the “Media full” error message appears.

---

For deleting a file, refer to page 3–168.

**Save Count Limit.** Sets a limit on the number of times that data is saved. This setting is enabled when the above-mentioned Save Count is On.

Setting range: 1 to 16383 (default: 100)

## IF Trigger

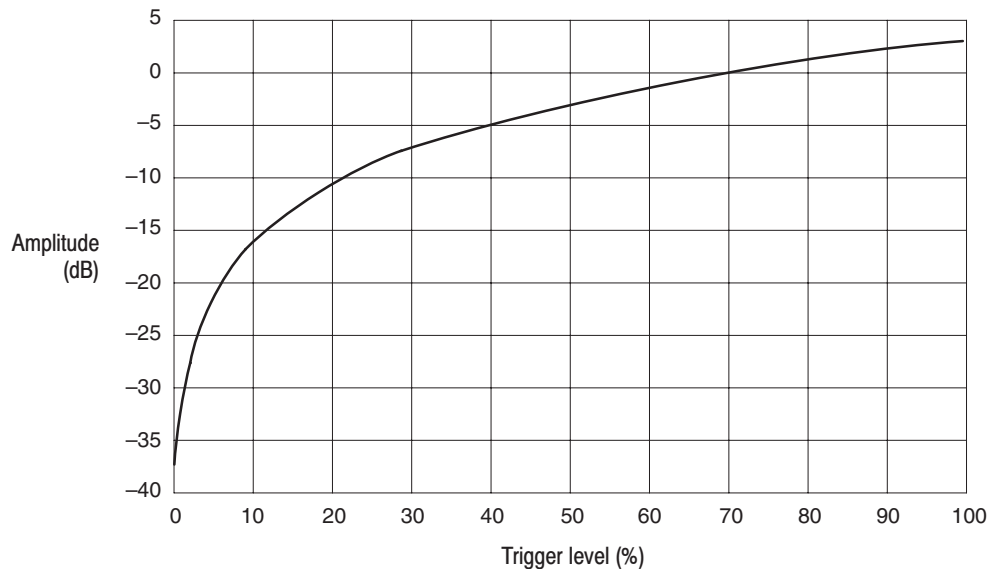
This section describes the IF trigger function, which operates when the trigger source is set to Level (Full BW). The IF trigger function monitors the level of signals that pass through the IF filter and generates a trigger when the level exceeds the threshold.

### Setting a Trigger Level

When IF trigger is selected, the trigger level can be set in the range of 1 to 100%. The full scale of the internal A/D converter is considered as 100%. This is almost equivalent to the set value of reference level. For example, if the reference level is set to +3 dBm, 3 dBm becomes the full scale of the A/D converter. If the trigger level is set to 100%, a trigger will occur when a signal with a level higher than 3 dBm is applied.

The Figure 3–72 shows the relationship between trigger level set values and signal power that causes a trigger to be generated when the reference level is +3 dBm and the input signal is a single sine wave. If the trigger level is set to 50%, the amplitude of –6 dB from the reference level corresponds to the signal power that causes a trigger. That is:

$$+3 \text{ dBm (reference level)} - 6 \text{ dB} = -3 \text{ dBm}$$



**Figure 3–72: Trigger level vs. Amplitude (reference level = +3 dBm)**

### Time and Frequency Domain Waveforms

The trigger level to be set with IF trigger is based not on the power of the signal in the frequency domain but on the level of the signal in the time domain. Note that the relationship between signal power and trigger level varies with the input signal waveform.

A waveform made by adding sine waves of 1 Hz, 3 Hz, and 5 Hz as shown in Figure 3–73 is given as an example. Figure A shows waveforms of 1 Hz, 3 Hz, and 5 Hz respectively, and the size is 1. Figure B shows the waveforms when the above signals are added. You can see that the voltage at the largest peak is more than twice the voltage of the original signals. On the frequency axis of Figure C, only signals of size 1 are generated at 1 Hz, 3 Hz, and 5 Hz. The IF trigger compares the waveform peak in Figure B with the trigger level set value. The level is therefore different from the power level of each frequency component on the spectrum (Figure C).

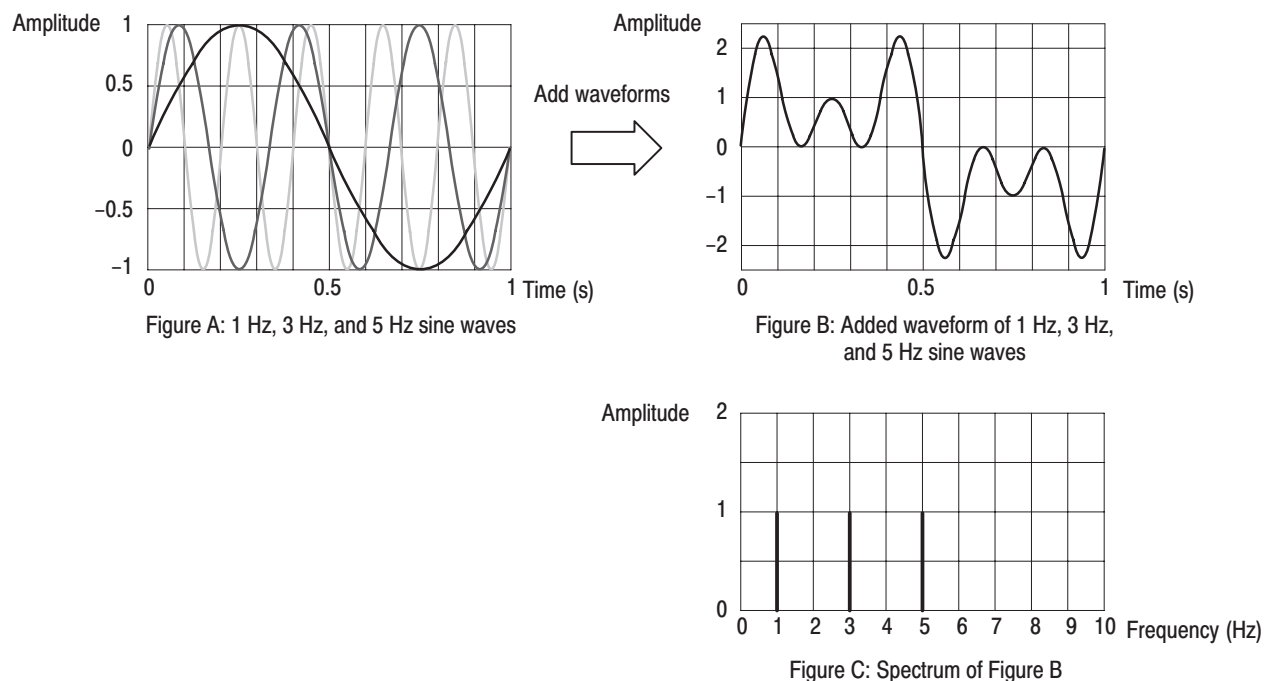
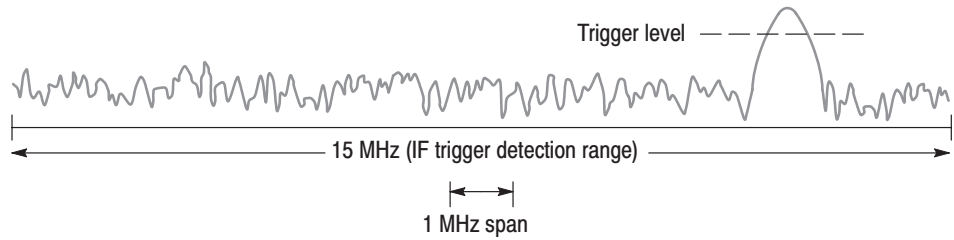


Figure 3–73: Waveforms in time domain and in frequency domain

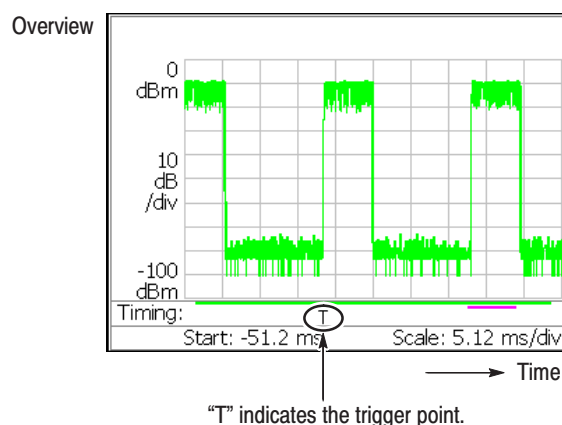
The IF trigger always observes the signal level of the IF bandwidth of approximately 15 MHz to determine trigger generation. Even if the span is 1 MHz, the bandwidth of approximately 15 MHz is the detection target of IF trigger. Note that, as shown in Figure 3-74, any signal exceeding the trigger level other than the range of 1 MHz of span activates the IF trigger even if no signal exceeds the trigger level within the range of 1 MHz of span.



**Figure 3-74: IF trigger detection range**

## Trigger Point Indicator

In the Demod (modulation analysis) and the Time (time analysis) modes, “T” is displayed in the Timing field on the overview. “T” indicates the trigger occurrence point in the Triggered mode, and is used as a reference point for setting the Timing parameters in the Free Run mode. However, “T” indicates the trigger output point when the trigger source is Power and the slope is *Rise and Fall* or *Fall and Rise*, or when the trigger source is Freq Mask.



**Figure 3-75: Trigger point display**

## Indicating Trigger Output

You can use the trigger output to synchronize the analyzer with other instruments. In the Demod (modulation analysis) and the Time (time analysis) modes, “O” indicating the trigger output time can be also displayed in the Timing field on the overview. The default status for “O” is off. Follow these steps to display the indicator:

1. Press the **TIMING** key on the front panel.
2. Press the **Output Trigger Indicator** side key to select **On**.

“O” appears on the overview.

The trigger output timing is determined by the analyzer hardware so that you cannot change it. For the external trigger, the output timing coincides with the trigger occurrence. For other triggers, there is no relationship between the timing of the trigger occurrence and that of the trigger output.

To connect the trigger output to other instruments, use the TRIG OUT connector on the rear panel (see *Rear Panel* on page 2-4). The output specification is: H level >2.0 V, L level <0.4V, and output current <1 mA.



# FFT and RBW

An input signal is converted to the frequency domain data by FFT (Fast Fourier Transform) processing. RBW (Resolution Bandwidth) processing is then applied, for compatibility with measurement data from conventional swept spectrum analyzers (see Figure 3–76). Moreover, the Real Time S/A mode has FFT overlap capability.

---

**NOTE.** You can set the FFT and RBW parameters in the S/A (spectrum analysis) mode. In the Demod (modulation analysis) and Time (time analysis) modes, the number of FFT points is always 1024 and the window is always Blackman-Harris 4B type. However, for the pulse measurements in the Time mode, you can select Nyquist or Blackman-Harris 4B (refer to RBW/FFT Menu on page 3–57). The Demod and Time modes have no RBW process.

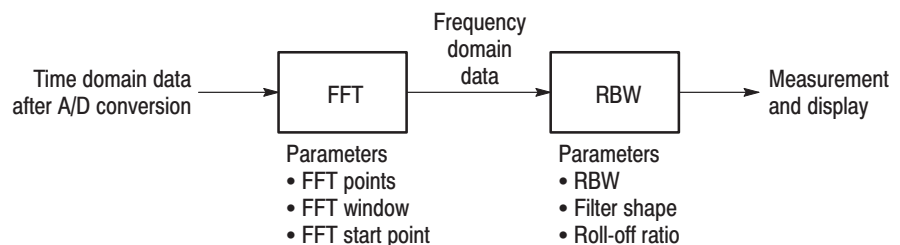
---

The adjustable parameters for FFT are:

- FFT points
- FFT window
- FFT start point (Real Time S/A only)

The adjustable parameters for RBW are:

- Resolution bandwidth (RBW)
- Filter shape
- Roll-off ratio (for the Nyquist or Root Nyquist filter)



\* FFT points is normally set automatically with the RBW setting.  
RBW is normally set automatically with the span setting.

**Figure 3–76: FFT and RBW process**

## RBW/FFT Menu

Figure 3–77 shows the RBW/FFT menu structure.

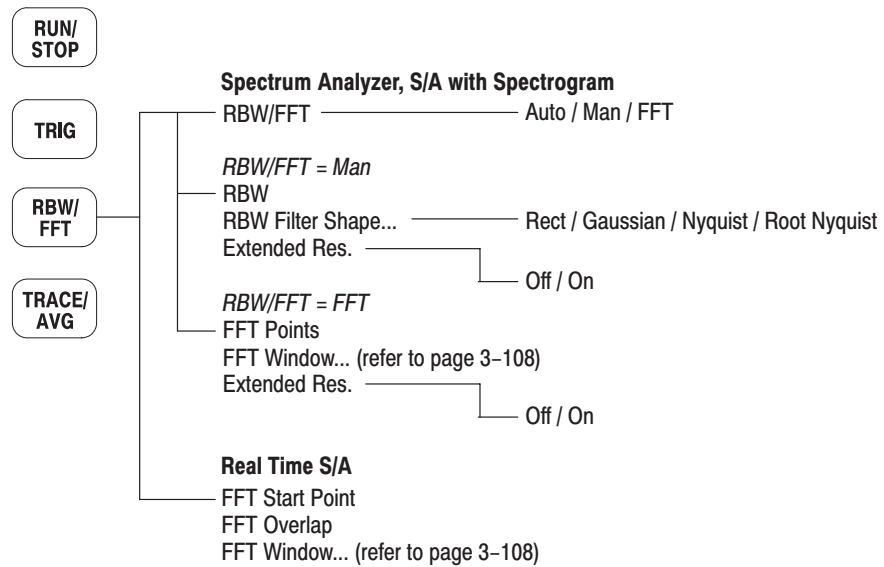


Figure 3–77: RBW/FFT menu tree

### Spectrum Analyzer and S/A with Spectrogram Modes

The RBW/FFT menu has the following controls in the Spectrum Analyzer and the S/A with Spectrogram modes:

**RBW/FFT.** Selects whether to set RBW and FFT parameters automatically or manually.

- **Auto.** Sets RBW automatically with the span setting. The filter shape is set to Gaussian.
- **Man.** Sets RBW and selects the filter manually with the **RBW** and **RBW Filter Shape...** side keys.
- **FFT.** Sets the FFT points and window manually with the **FFT Points** and **FFT Window...** side keys. The result of FFT processing is displayed as is, without RBW processing.

#### When RBW/FFT is set to Man.

**RBW.** Sets RBW when Man is selected in RBW/FFT.  
Range: 2 kHz to 2 MHz (the default is 80 kHz)



**RBW Filter Shape...** Selects the filter from the following four types when RBW/FFT is set to Man:

- Rect (Rectangular)
- Gaussian (default)
- Nyquist
- Root Nyquist

**Rolloff Ratio.** Enters roll-off ratio when RBW Filter Shape is set to Nyquist or Root Nyquist. Range: 0.0001 to 1 (the default is 0.5)

**Extended Res.** The FFT point number is normally limited internally. You can eliminate the limit using the On setting. Refer to *Limit on the FFT Points* on page 3–107 for detail.

---

**NOTE.** *It is recommended to keep Extended Res. Off as its default condition.*

---

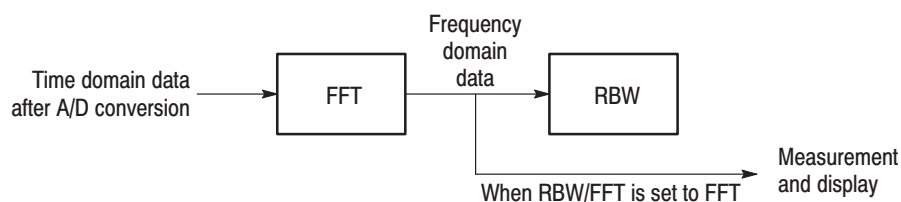
#### When RBW/FFT is set to FFT.

**FFT Points.** Selects FFT sample point numbers per frame when RBW/FFT is set to FFT. Range: 64 to 65536 in increments of  $2^n$ . Higher numbers provide higher resolution, and lower numbers provide faster measurements.

**FFT Window...** Selects the FFT window (window function) when RBW/FFT is set to FFT. For the window type, refer to Table 3–11 on page 3–110. The default is Blackman-Harris 4B.

**Extended Res.** Same as when RBW/FFT is set to Man.

When RBW/FFT is set to FFT, the waveform without RBW processing is displayed on screen (see Figure 3–78).



**Figure 3–78: Process flow when RBW/FFT = FFT**

**Real Time S/A Mode**

The Real Time S/A mode has FFT overlap capability that computes FFT while overlapping 1024-point FFT frames by a specified number of samples. The RBW/FFT menu contains the following controls:

---

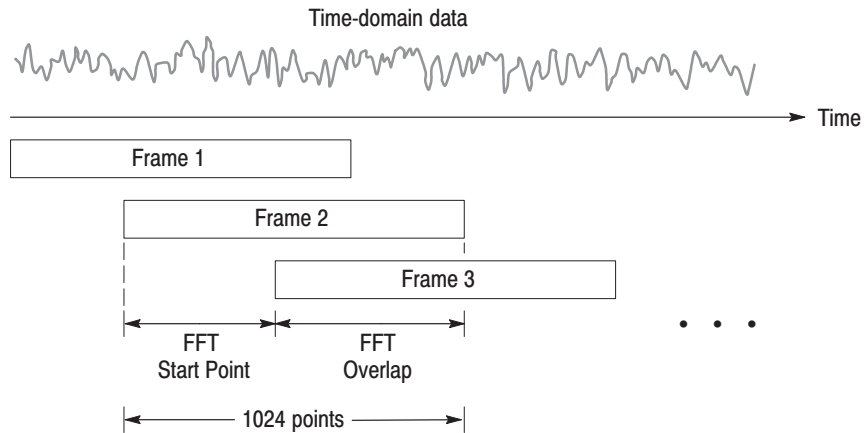
**NOTE.** *In the Real Time S/A mode, the FFT points is always 1024 and FFT-processed data does not go through RBW process (see Figure 3–78 on page 3–105).*

---

**FFT Start Point.** Sets the start point of the 1024-point FFT frame by the number of samples from the previous frame (see Figure 3–79).  
Range: 1 to 1024 samples in increments of  $2^n$ .

**FFT Overlap.** Displays the amount of overlap between frames used to calculate consecutive FFTs (see Figure 3–79). Not settable. The sum of FFT Overlap and FFT Start Point is always 1024.

**FFT Window...** Selects the FFT window (window function).  
For the window type, refer to Table 3–11 on page 3–110.  
The default is Blackman-Harris 4B.



**Figure 3–79: FFT overlap**

## FFT Points

The number of FFT points is normally set automatically by the RBW setting. The value is basically 1024. It can be set in powers of 2 from 64 to 8192. This value is the number of points in one physical frame in the time and frequency domains. If the number of points is reduced, the frame period is shortened and more spectrum variations can be observed in the spectrogram view. If the number of the points is increased, S/N ratio and frequency resolution are improved.

---

**NOTE.** Setting the number of FFT points greater than the limit (8192) causes the noise floor to go down and occasionally causes spurious signals to appear (see Figure 3–80). It cannot be determined whether the spurious signal comes from the input signal or the instrument.

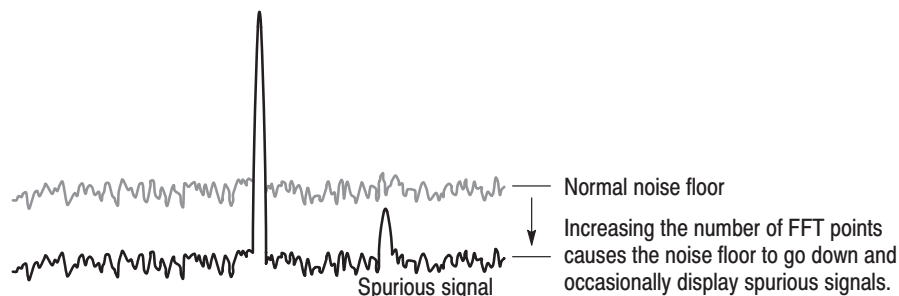
---

### Limit on the FFT Points

The number of FFT points is normally limited to 8192 internally to avoid displaying internally-generated spurious signals. However, you can remove this restriction and set the number of FFT points up to 65536 using the following steps:

1. Display the measurement signal on the screen.
2. Press the **RBW/FFT** key on the front panel.
3. Press the **RBW/FFT** side key to select **FFT**.
4. Press the **Extended Res.** side key to select **On**.
5. Press the **FFT Points** side key and select the value with the general purpose knob. The range extends up to 65536 in powers of 2.

The waveform after FFT is displayed with the selected number of points.



**Figure 3–80: Generating spurious signals by increasing the number of FFT points**

## FFT Window

The phase of the waveform processed by FFT analysis is assumed to start at zero and end at zero, so the waveform data is an exact multiple of one cycle. If the phase at the start and end of the waveform are equal, there is no unnatural discontinuity in the signal waveform, and the frequency and the amplitude can be accurately calculated.

If the waveform data is not an exact multiple of one cycle, the amplitudes at the start and end of the waveform will be different. There will be a discontinuity of the waveform between the beginning and end, and a high-frequency transient phenomenon occurs. When this happens, inaccurate frequency information is recorded in the frequency domain.

If a window function is applied to the waveform, the start and end amplitudes will be closer, and the discontinuity is reduced. The frequency components that are calculated from the signal by FFT also become more accurate. Choose the FFT window according to your objective: accurate measurement of the frequency or accurate measurement of the amplitude of the frequency components.

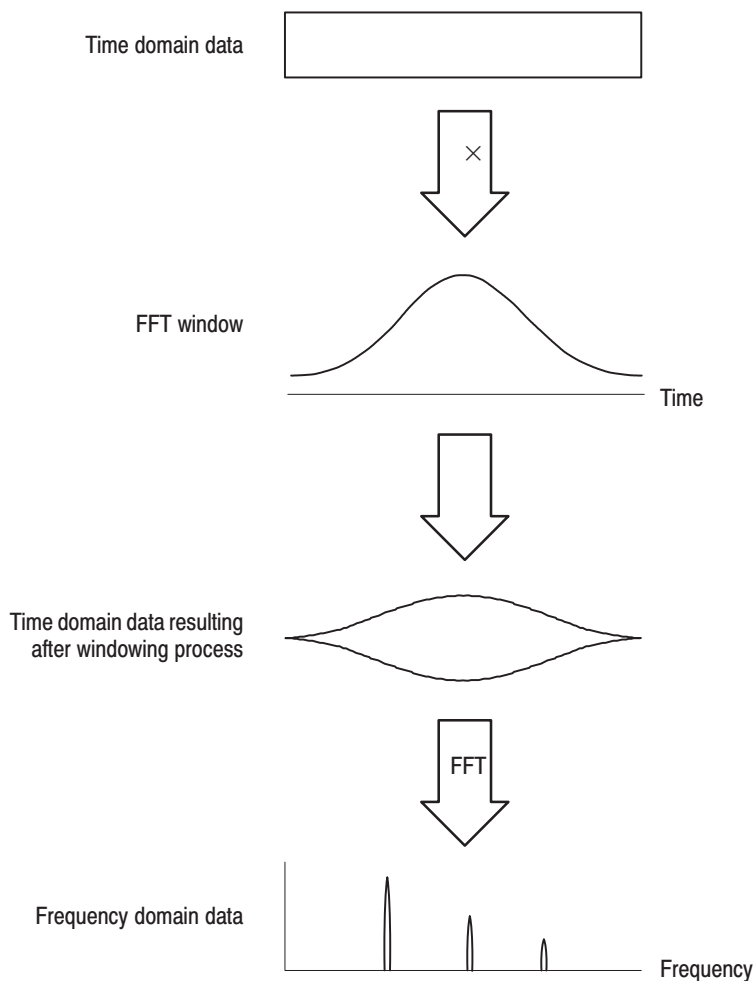
### Window Characteristics

In FFT windows, the frequency resolution is inversely proportional to the amplitude accuracy. Select a proper window according to the measurement items and characteristics of the signal source. Table 3–10 shows characteristics and usages of major windows.

**Table 3–10: Characteristics and usage of FFT windows**

FFT window	Characteristics	Usage
Rectangular	<ul style="list-style-type: none"> <li>■ Suitable for frequency measurement but not suitable for amplitude measurement.</li> <li>■ Same result as measurement without a window.</li> </ul>	<ul style="list-style-type: none"> <li>■ Transient phenomenon or burst; signal levels before and after the event are roughly same.</li> <li>■ Sinusoidal wave with little amplitude variation and stable frequency.</li> <li>■ Wide bandwidth irregular noise; spectrum changes slowly.</li> </ul>
Hamming, Hanning	<ul style="list-style-type: none"> <li>■ Suitable for frequency measurement.</li> <li>■ Inferior in accuracy of amplitude to the rectangular window.</li> <li>■ Frequency resolution of Hamming is slightly superior to that of Hanning.</li> </ul>	<ul style="list-style-type: none"> <li>■ Sinusoidal wave.</li> <li>■ Repeating narrow bandwidth irregular noise.</li> <li>■ Transient phenomenon or burst; signal levels before and after the event are remarkably different.</li> </ul>
Blackman-Harris	<ul style="list-style-type: none"> <li>■ Suitable for amplitude measurement but not suitable for frequency measurement.</li> </ul>	<ul style="list-style-type: none"> <li>■ Signal that has one-frequency ruling when a high order harmonic is detected.</li> </ul>

Figure 3–81 outlines how frequency domain data is generated from time domain data. The FFT window serves as a bandpass filter between time and frequency domain data. The FFT frequency resolution and amplitude accuracy of each frequency component depends on the window shape.



**Figure 3–81: Windowing process of time domain data**

Generally, window frequency resolution is inversely proportional to the accuracy of measuring amplitude levels. For ordinal measurements, select the window capable of separating the desired frequency component. Such a window maximizes the accuracy of measuring amplitude levels and minimizes leakage error while separating each frequency component.

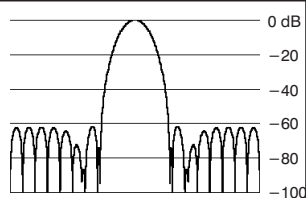
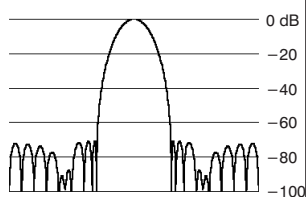
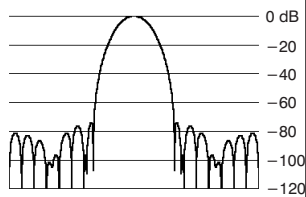
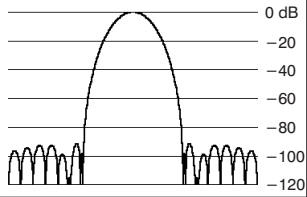
To select a proper window, first select the rectangular window, then sequentially switch to a window with less frequency resolution, such as Hamming, Hanning, or Blackman-Harris. Use the last window that still passes the frequency component to be separated. Suitable frequency resolution and amplitude accuracy are obtained by using the window immediately before the one from which the frequency component cannot be separated.

Consider the following characteristics when selecting a window for your purpose:

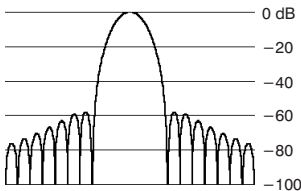
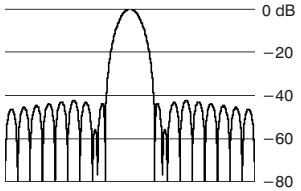
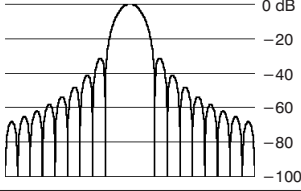
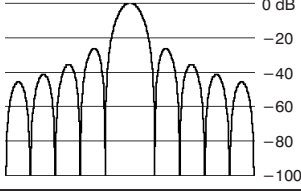
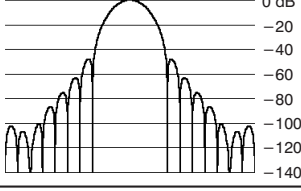
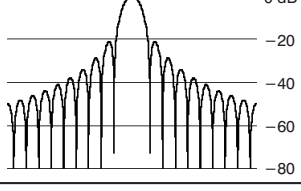
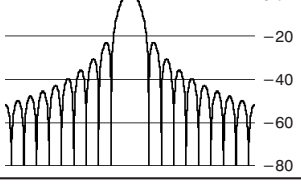
- Frequency resolution is improved by reducing the width of the main lobe window.
- Accuracy of the amplitude levels of frequency components is improved by reducing side lobe level relative to the main lobe.

**Window Type** The analyzer supports a total of 15 windows, including the major windows mentioned previously (refer to Table 3–11).

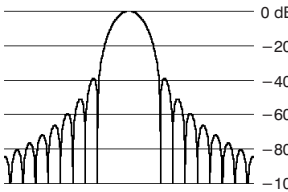
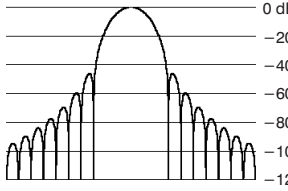
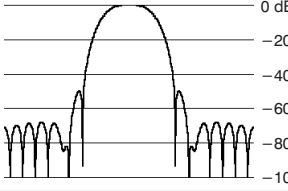
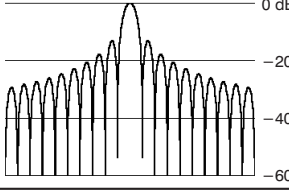
**Table 3–11: FFT window and bandpass filter**

Window	Bandpass filter	-3 dB bandwidth	Maximum side lobe	Equivalent noise bandwidth
Blackman-Harris 3 sample A type		1.53	-62 dB	1.61075
Blackman-Harris 3 sample B type		1.622	-71 dB	1.708538
Blackman-Harris 4 sample A type		1.698	-76 dB	1.793948
Blackman-Harris 4 sample B type (Default)		1.898	-92 dB	2.004353

**Table 3-11: FFT window and bandpass filter (Cont.)**

Window	Bandpass filter	-3 dB bandwidth	Maximum side lobe	Equivalent noise bandwidth
Blackman	 A plot of the Blackman bandpass filter showing a main lobe and side lobes. The y-axis is labeled from 0 dB to -100 dB in increments of 20 dB.	1.642	-58 dB	1.726757
Hamming	 A plot of the Hamming bandpass filter showing a main lobe and side lobes. The y-axis is labeled from 0 dB to -80 dB in increments of 20 dB.	1.302	-43 dB	1.362826
Hanning	 A plot of the Hanning bandpass filter showing a main lobe and side lobes. The y-axis is labeled from 0 dB to -100 dB in increments of 20 dB.	1.438	-32 dB	1.5
Parzen	 A plot of the Parzen bandpass filter showing a main lobe and side lobes. The y-axis is labeled from 0 dB to -100 dB in increments of 20 dB.	1.27	-27 dB	1.330747
Rosenfield	 A plot of the Rosenfield bandpass filter showing a main lobe and side lobes. The y-axis is labeled from 0 dB to -140 dB in increments of 20 dB.	1.814	-48 dB	1.90989
Welch	 A plot of the Welch bandpass filter showing a main lobe and side lobes. The y-axis is labeled from 0 dB to -80 dB in increments of 20 dB.	1.15	-21 dB	1.197677
Sine Lobe	 A plot of the Sine Lobe bandpass filter showing a main lobe and side lobes. The y-axis is labeled from 0 dB to -80 dB in increments of 20 dB.	1.186	-23 dB	1.233702

**Table 3-11: FFT window and bandpass filter (Cont.)**

Window	Bandpass filter	-3 dB bandwidth	Maximum side lobe	Equivalent noise bandwidth
Sine Cubed		1.654	-39 dB	1.734891
Sine to the 4 <sup>th</sup>		1.85	-47 dB	1.944444
Flat Top		3.182	-51 dB	3.196927
Rectangular		0.886	-13 dB	1



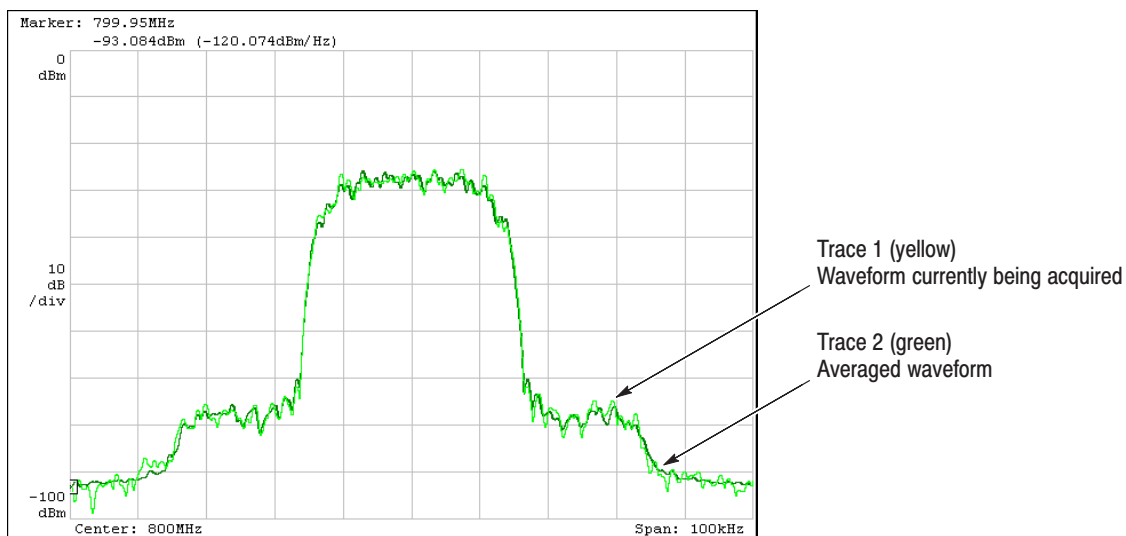
# Trace Comparison Display and Average Function

In the spectrum analysis (S/A mode), you can display two traces concurrently on screen. Trace 1 is displayed in yellow and Trace 2 in green (see Figure 3–82). The trace can be averaged for noise reduction. You can save waveform data in files, and load them as Trace 1 or 2.

---

**NOTE.** Trace comparison display and average function are available in the spectrum analysis (S/A) mode except Real Time S/A.

---



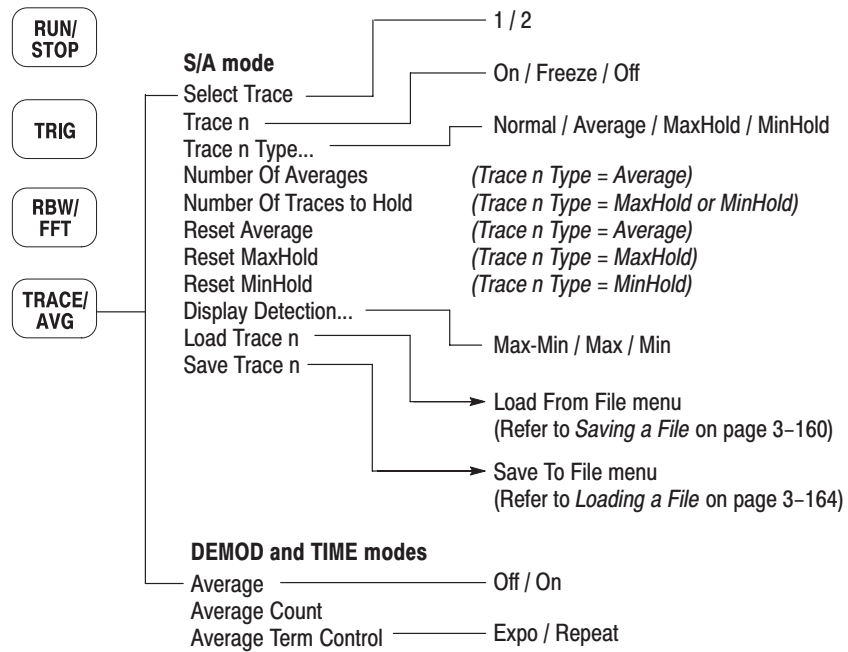
**Figure 3–82: Comparison display of Trace 1 and 2**

The main topics in this section are:

- Trace/Avg menu
- Displaying Trace 1 and 2
- Averaging waveform
- Saving/Loading waveform data
- Trace compression display

## Trace/Avg Menu

Controls the trace display and averaging. The menu items vary according to the measurement mode: S/A, Demod, or Time.



**Figure 3-83: RBW/FFT menu structure**

**S/A Mode** The Trace/Avg menu has the following controls in the S/A mode.

---

**NOTE.** The Trace/Avg menu is not available in the Real Time S/A mode.

---

**Select Trace.** Selects the trace to control: trace 1 or 2.

**Trace 1/2.** Controls the selected trace.

- **On.** Turns on the selected trace.
- **Freeze.** Freezes display of the selected trace.
- **Off.** Turns off the selected trace.

**Trace 1/2 Type...** Selects the type of processing for the selected trace.

- **Normal.** Displays normal waveform without averaging.
- **Average.** Averages the selected trace.
- **Max Hold.** Holds the maximum value at each data point on the waveform.
- **Min Hold.** Holds the minimum value at each data point on the waveform.

**Number Of Averages.** Specifies how many traces are accumulated to create the averaged value. Setting range: 1 to 100000 (default: 20).

Averaging is controlled in two ways as shown in Table 3–12.

**Table 3–12: Averaging method**

Data acquisition	Average type	Number of Averages
Free run (Continuous mode only)	Exponential RMS	Continues the average with an exponential weighting applied to old values using Number of Averages as the weighting factor.
Triggered and Single mode	RMS	Averages traces accumulating up to Number of Averages, then stops the acquisition until the next trigger event occurs.

**Reset Average.** Causes trace accumulation to start over.

**Display Detection...** The bin data is thinned out in the display because the number of pixels in the horizontal direction of the screen is generally smaller than the number of bins in the FFT. Display Detection selects the method to be used for decimating traces to fit the available space. It is related only to the thinning of displayed data.

- **Max-Min.** Draws a line connecting the maximum and the minimum values of data corresponding to each pixel.
- **Max.** Displays the maximum value of data corresponding to each pixel.
- **Min.** Displays the minimum value of data corresponding to each pixel.

The analyzer performs RMS detection using the linear A/D converter regardless of the Display Detection setting.

Refer to page 3–120 for details on compression of waveform display data.

**Load Trace.** Loads trace data from a file.

**Save Trace.** Saves trace data to a file.

Refer to *File Operations* on page 3–157 for details on saving/loading data to/from a file.

## Demod and Time Modes

The Trace/Avg menu has the following controls in the Demod and Time modes.

**Average.** Determines whether to perform averaging.

- **On.** Turn averaging on.
- **Off.** Turn averaging off.

---

**NOTE.** For Demod and Time modes, data is always acquired without averaging.

---

**Average Count.** Specifies the number of measurements to combine.  
Setting range: 1 to 10000 (default: 20).

**Average Term Control.** Specifies the action when more than Average Count measurement results are generated.

- **Expo.** Continues the average with an exponential weighting applied to old values.
- **Repeat.** Clears average data and counter, and restarts the average process.

## Displaying Trace 1 and 2

Only Trace 1 (yellow) is displayed by default. Use the following steps to select Trace 1 and 2:

1. Press the **TRACE/AVG** key on the front panel.
2. Press the **Select Trace** side key to select the trace (1 or 2) to be controlled. For example, to control Trace 2, select **2**.
3. Press the **Trace 1 (or 2)** side key to select the display method: On, Freeze, or OFF.
4. Press the **Trace 1 (or 2) Type...** side key to select the trace type: Normal, Average, MaxHold or MinHold (refer to Trace 1/2 Type on page 3–115).
5. Repeat steps 2 through 4 for Trace 1 and 2.

## Averaging the Waveform

The averaging technique is generally used to average and reduce the noise of the waveform. The average function includes the peak hold which maintains the maximum and minimum values as well as the averaging process.

**Average Type** There are four averaging types as follows, where these variables are used:

$X(p)_n$ : Display data for the  $n^{\text{th}}$  frame  
 $x(p)_n$ : Active data for the  $n^{\text{th}}$  frame  
 $P$ : Frame point  
 $N$ : Value of “Number of Averages”

**RMS.** Root-mean-square. Used when acquiring data in single mode.  $N$  frames average, then the acquisition stops.

$$\begin{aligned} X(p)_n &= x(p)_n && \text{for : } n = 1 \\ X(p)_n &= \frac{(n-1) \times X(p)_{n-1} + x(p)_n}{n} && \text{for : } 2 \leq n \leq N \\ X(p)_n &= x(p)_N && \text{for : } n > N \end{aligned}$$

**Exponential RMS.** Exponential root-mean-square. Used when acquiring data in continuous mode. Continuous averaging weights older sweeps so that they have a progressively smaller effect on the average.

$$\begin{aligned} X(p)_n &= x(p)_n && \text{for : } n = 1 \\ X(p)_n &= \frac{(n-1) \times X(p)_{n-1} + x(p)_n}{n} && \text{for : } 2 \leq n \leq N \\ X(p)_n &= \frac{(N-1) \times X(p)_{n-1} + x(p)_n}{N} && \text{for : } n > N \end{aligned}$$

**Max Hold.** Displays only the maximum value at each data point.

$$\begin{aligned} X(p)_n &= x(p)_n && \text{for : } n = 1 \\ X(p)_n &= \max(X(p)_{n-1}, x(p)_n) && \text{for : } n \geq 2 \end{aligned}$$

**Min Hold.** Displays only the minimum value at each data point.

$$\begin{aligned} X(p)_n &= x(p)_n && \text{for : } n = 1 \\ X(p)_n &= \min(X(p)_{n-1}, x(p)_n) && \text{for : } n \geq 2 \end{aligned}$$

**Averaging Example**

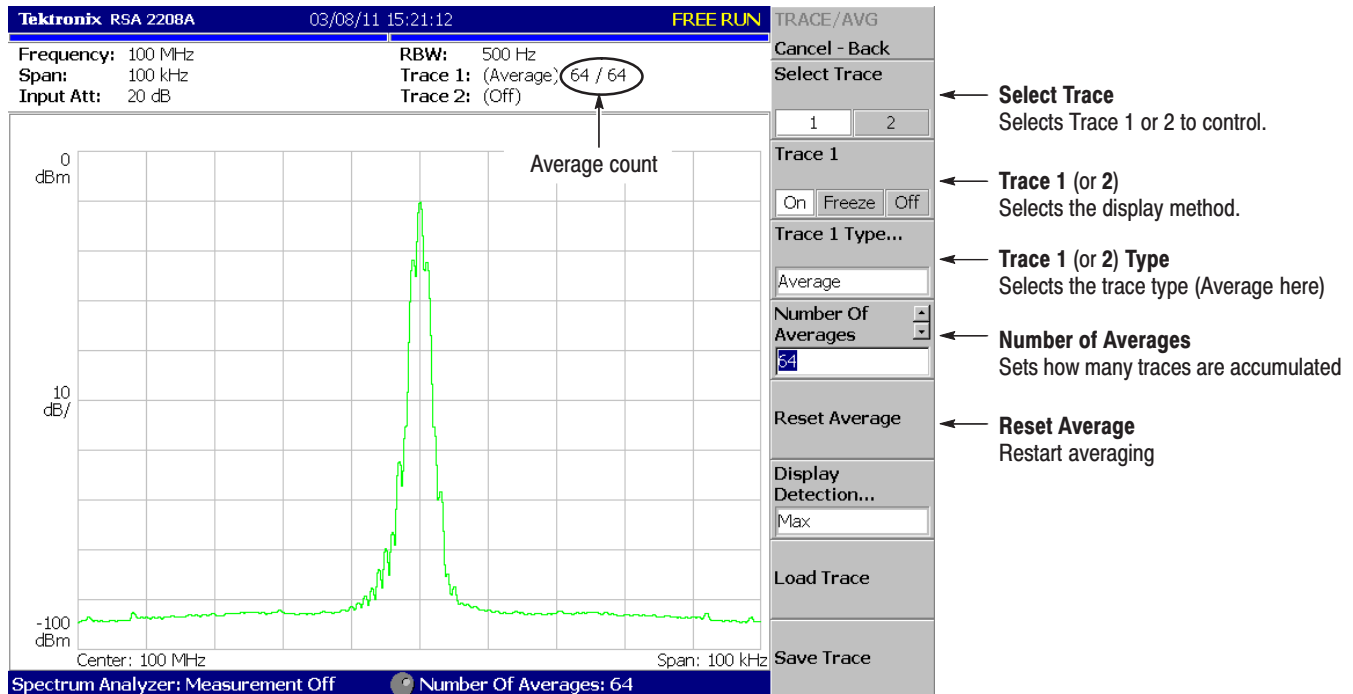
This section shows how to use averaging and the compared display.

**Performing Averaging.** Average and display Trace 1.

1. Display the spectrum of the measurement signal.
2. Pause data acquisition to simplify the operation. If you are acquiring the data in the continuous mode, press the **RUN/STOP** key to stop the acquisition.
3. Press the **TRACE/AVG** key on the front panel.
4. Press the **Select Trace** side key to select **1**.
5. Press the **Trace 1 Type** side key and select **Average** for example.
6. Press the **Number of Averages** side key and set **64** for example.
7. Press the **RUN/STOP** key to acquire data.
8. Press the **Reset Average** side key to perform averaging again.

The averaged waveform is displayed on screen (see Figure 3–84).

The average count is indicated in the right top portion of the screen.



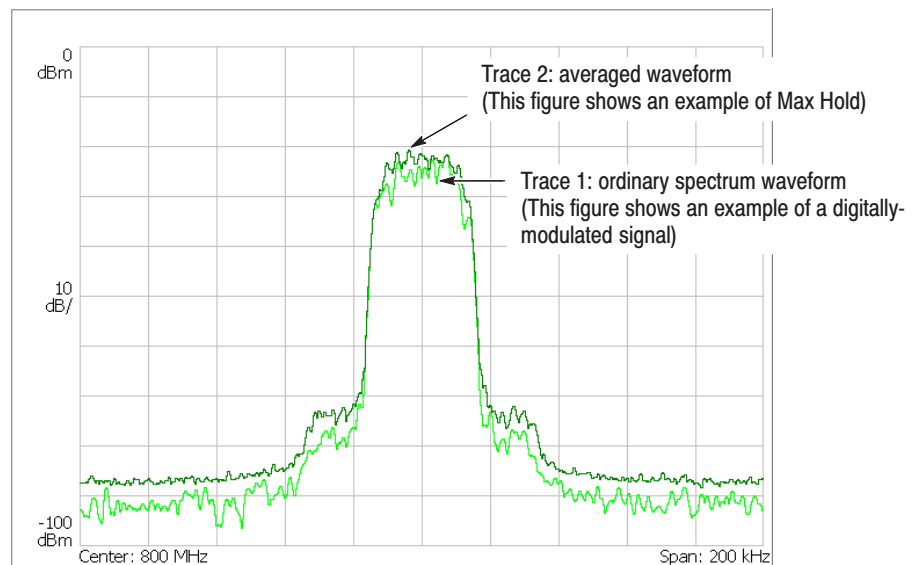
**Figure 3–84: Displaying an averaged waveform**

**Compared Display.** Display Trace 1 as a normal spectrum and Trace 2 as the averaged waveform concurrently, and compare them.

1. Display the spectrum of the measurement signal.
2. Press the **TRACE/AVG** key on the front panel.
3. Display Trace 1 as a normal spectrum.
  - a. Press the **Select Trace** side key to select **1**.
  - b. Press the **Trace 1 Type...** side key and select **Normal**.
4. Display Trace 2 as the averaged waveform.
  - a. Press the **Select Trace** side key to select **2**.
  - b. Press the **Trace 2 Type...** side key and select **Average, Max Hold** or **Min Hold**.

The waveform currently being acquired (trace 1 in yellow) and the averaged waveform (trace 2 in green) are displayed together.

Figure 3–85 shows an example of the concurrent display of the ordinal spectrum and its Max Hold waveform.



**Figure 3–85: Compared display**

## Saving/Loading Waveform Data

You can save the waveform data currently being acquired in a file, and load the saved data as trace 1 or 2.

### Saving a Trace

To save Trace 1 or 2 in a file:

1. Press the **TRACE/AVG** key on the front panel.
2. Press the **Select Trace** side key to select Trace 1 or 2.
3. Press the **Save Trace** side key and select the destination file. For information about file operations, refer to page 3–157 and subsequent pages.

### Loading a Trace

To load Trace 1 or 2 from a file:

1. Press the **TRACE/AVG** key on the front panel.
2. Press the **Select Trace** side key to select Trace 1 or 2.
3. Press the **Load Trace** side key and select the source file. (The trace is automatically frozen.) For information about file operations, refer to page 3–157 and subsequent pages.

## Trace Compression

Although waveform data are acquired as 1024 points per frame, the acquired data are displayed after being thinned out and compressed due to the limitation of the number of pixels on screen. The compression method and the procedure to select the method are described in the following section.

### Relation between Frame, Bin, and Pixel

One frame contains FFT points (1024) of data. Part of the data in the frame is invalid for the calculation. The analyzer discards invalid data and displays only valid data. Valid data are called “bin”. The number of bins depends on the span as shown in Table 3–13.

**Table 3–13: Number of bins (FFT points: 1024)**

Span	Number of bins
2 MHz or less	641
5 MHz	801
10 MHz	801
20 MHz (Baseband only)	801



The number of bins is valid in all modes except Scalar mode. The number of bins is meaningless in Scalar mode because it uses several physical frames to display data. Generally, the following calculations are used:

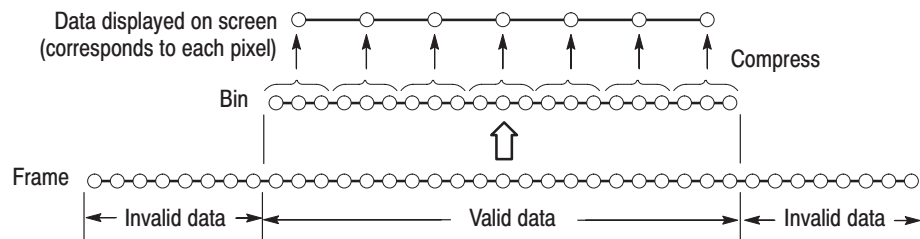
$$\text{Frequency bandwidth of one bin} = (\text{Sampling rate}) / (\text{Number of FFT points})$$

$$\text{Number of bins} = (\text{Specified span}) / (\text{Frequency bandwidth of one bin}) + 1$$

The sampling rate varies depending on span. Refer to page A-7 in *Appendix A: Specifications* for more details.

### Compression Method

Generally, because the number of horizontal pixels on screen is smaller than the number of bins, bin data is compressed according to the number of pixels on screen when they are displayed (see Figure 3-86).



**Figure 3-86: Relationships between frame, bin, and pixel**

There are three types of compression methods:

Max, Min, and Max-Min (see Figure 3-87 on page 3-122).

### Selecting Compression Method

Max is the most commonly used compression method. Max-Min is used in the time domain waveform display in the DEMOD mode. (The compression method is always set to Max on the spectrogram view in three-dimensional modes.)

You can select the compression method using the following steps in S/A mode:

1. Press the **TRACE/AVG** key on the front panel.
2. Press the **Display Detection...** side key and select **Max**, **Min**, or **Max-Min**.

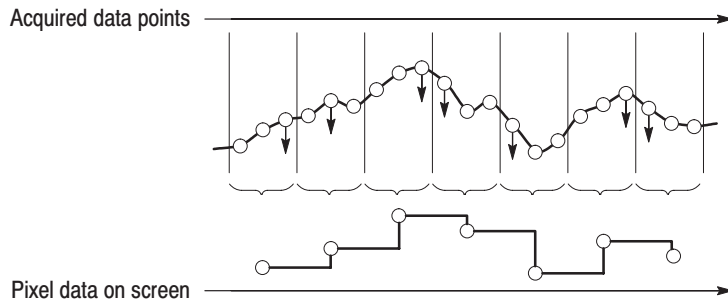
---

**NOTE.** *Display Detection determines how to deal with data between spectrum display points. The analyzer performs RMS detection using the linear A/D converter regardless of the Display Detection setting.*

---

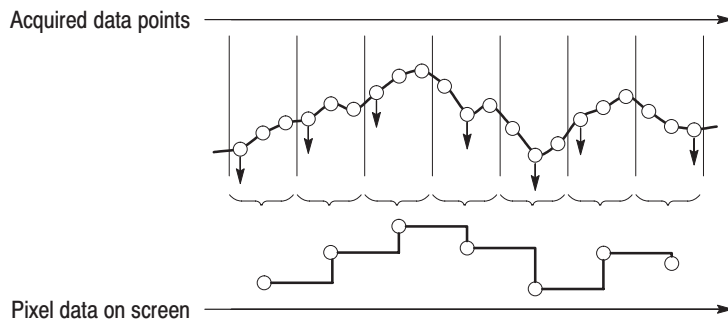
**Max**

Acquires the maximum value of data points corresponding to each pixel.



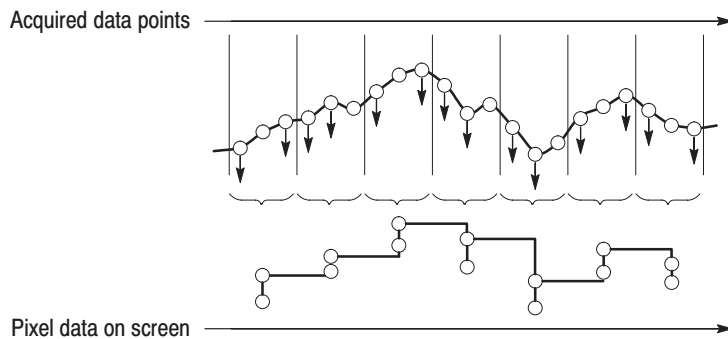
**Min**

Acquires the minimum value of data points corresponding to each pixel.



**Max-Min**

Acquires the minimum and maximum values of data points corresponding to each pixel.



**Figure 3-87: Compression method for displaying the waveform**

# Setting Views

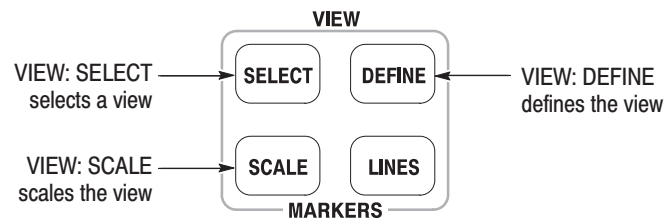
This section describes scaling and formatting for the following view types:

- Spectrum view
- Spectrogram view
- Time domain view
- CCDF view

## View Menu

Use the following View keys on the front panel to scale and format views:

- SELECT** Selects a view when displaying two or three views on screen. The view switches each time you press this key. The selected view is surrounded with a white box.
- DEFINE** Selects a view style, format, and content. The menu items depend on the measurement. Refer to each measurement description.
- SCALE** Sets the horizontal and vertical axes for the view selected with the **SELECT** key.



**Figure 3-88: View keys**

## Basic Procedure

The following procedures set the scale or format the view using the VIEW keys in single view or multiple views.

**Procedure for Single View.** When you are displaying one view on screen, press the VIEW: **SCALE** key and set the scale. For the Scale menu of a specific view, refer to the following pages.

**Procedure for Multiple Views.** When you are displaying multiple views on the screen, follow these steps:

1. Select a view by pressing the VIEW: **SELECT** key.  
The selected view is surrounded by a white frame.
2. If necessary, change a multiple view display to a single view display:
  - a. Press the VIEW: **DEFINE** key.
  - b. Press the **Show Views** side key to select **Single**.  
Only the selected view will be displayed.
3. Set the scale by pressing the VIEW: **SCALE** key.
4. If necessary, return to the multiple view display:
  - a. Press the VIEW: **DEFINE** key.
  - b. Press the **Show Views** side key to select **Multi**.

Refer to page 3–32 for information about changing the overview and the subview using the Define menu.

## Spectrum View Setting

The spectrum view is the frequency domain representation of a signal. It indicates frequency along the horizontal axis and power along the vertical axis.

### View: Scale Menu

The Scale menu for the spectrum view contains the following controls (see Figure 3–89):

**Auto Scale.** Sets the start value and the scale of the vertical axis automatically to fit the waveform to the screen.

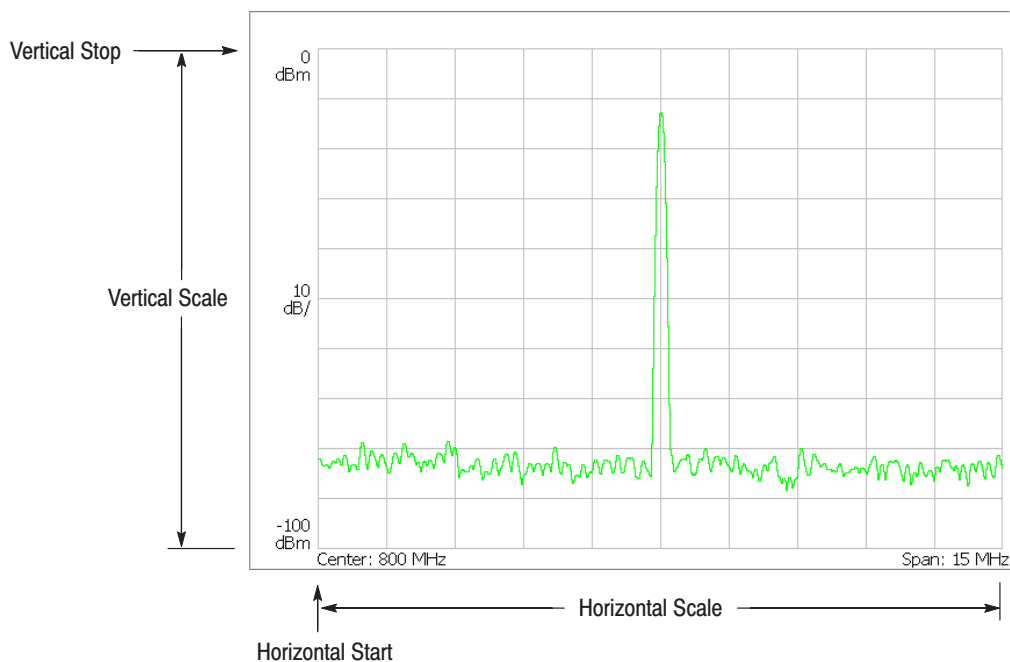
**Horizontal Scale.** Sets the range of the horizontal axis.

**Horizontal Start.** Sets the minimum value (left edge) of the horizontal axis.

**Vertical Scale.** Sets the range of the vertical axis.

**Vertical Stop.** Sets the maximum value (top) of the vertical axis.

**Full Scale.** Sets the scale of the vertical axis to the default full-scale value.



**Figure 3–89: Setting the scale in spectrum view**

## Spectrogram View Setting

The spectrogram view shows time-varying spectrum three-dimensionally. It indicates frequency along the horizontal axis, frame number along the vertical axis, and power level by using color. This view is used in the *S/A with Spectrogram* and *Real Time S/A* modes, or the Demod and Time modes as the overview content.

---

**NOTE.** *When you select S/A with Spectrogram in the S/A mode, you cannot set the scale of spectrogram.*

---

### View: Scale Menu

The Scale menu for the spectrogram view contains the following controls (see Figure 3–90):

**Auto Scale.** Sets the start value and the scale of the color axis automatically to fit the spectrogram to the screen.

**Horizontal Scale.** Sets the range of the horizontal axis.

**Horizontal Start.** Sets the minimum value (left edge) of the horizontal axis.

**Vertical Size.** Sets the range of the vertical axis. Range: 87 to 89088 frames.

**Vertical Start.** Sets the start frame number for the vertical axis.

**Color Scale.** Sets the scale (value subtracting the minimum power value from the maximum power value) of the color axis. The level is represented in 100 steps (100 colors) from the minimum value (blue) to the maximum value (red) in the default state.

**Color Stop.** Sets the maximum value (top) of the color axis.

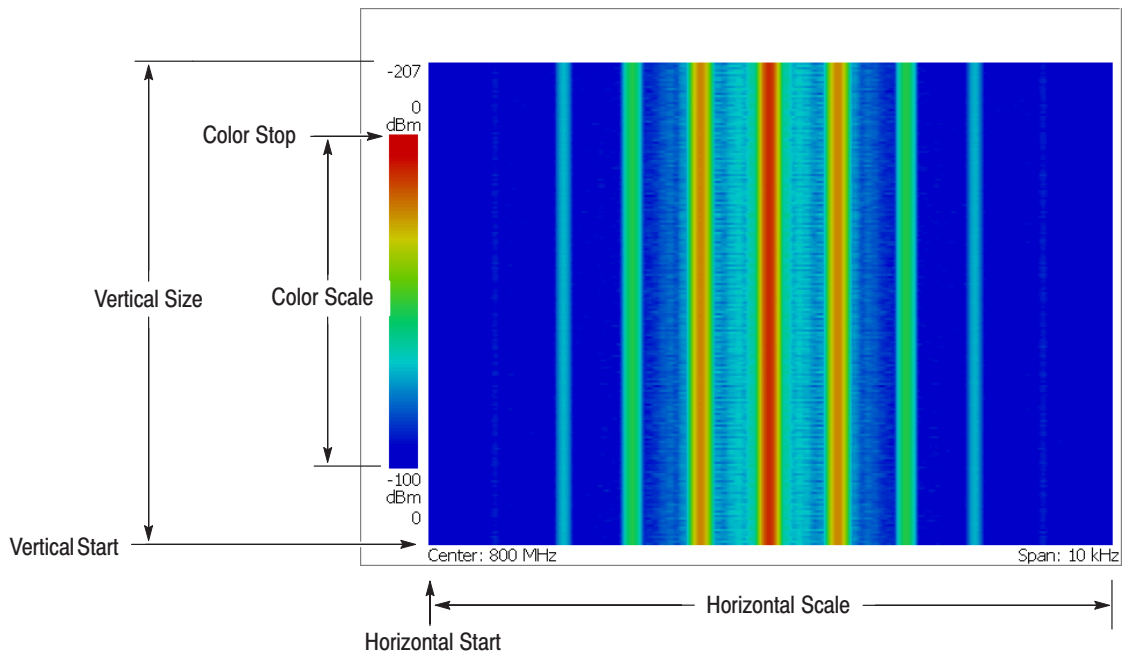
**Full Scale.** Sets the maximum value of the color axis to the reference level and the height to 100 dB.

The following menu items appear when the overview is a spectrogram in the Demod (modulation analysis) and the Time (time analysis) modes.

**Step to Spectrum Window.** Vertical Start is automatically set so that the frame displayed as a spectrum in the subview appears on the spectrogram.

**Step to Analysis Window.** Vertical Start is automatically set so that the frame analyzed and displayed in the main view appears on the spectrogram.

**Step to Trigger.** Vertical Start is automatically set so that the frame at the trigger position appears on the spectrogram.



**Figure 3-90: Scale and format settings in spectrogram view**

## Time Domain View Setting

The time domain view includes the following five displays shown on the overview or the main view in the Demod and the Time modes:

- Power versus Time
- AM demodulation display (modulation factor versus time)
- FM demodulation display (frequency deviation versus time)
- PM demodulation display (phase deviation versus time)
- I/Q level versus Time

### View: Scale Menu

The Scale menu for the time domain view contains the following controls (see Figure 3–91):

**Auto Scale.** Sets the start value and the scale of the vertical axis automatically to fit the waveform to the screen.

**Horizontal Scale.** Sets the range of the horizontal axis.

**Horizontal Start.** Sets the minimum value (left edge) of the horizontal axis.

**Vertical Scale.** Sets the range of the vertical axis.

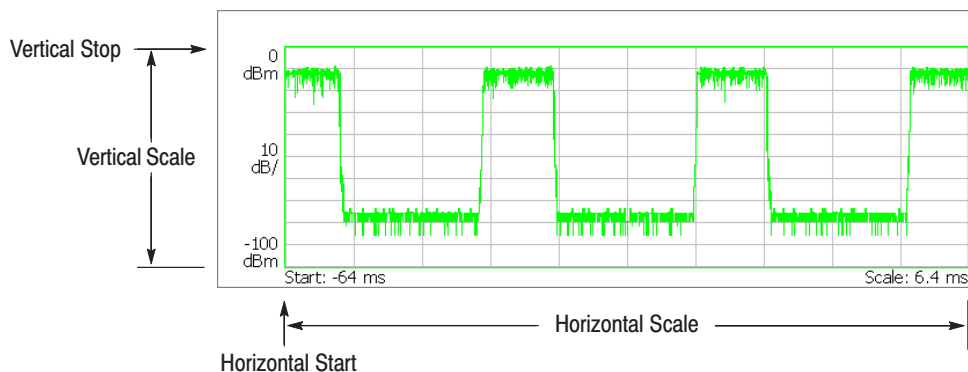
**Vertical Stop.** Available when the vertical axis represents power. Sets the maximum value (top) of the vertical axis.

**Vertical Offset.** Available when the vertical axis represents AM modulation factor, FM frequency deviation, PM phase deviation, or IQ voltage. Sets the center value  $((\text{maximum} + \text{minimum}) / 2)$  of the vertical axis.

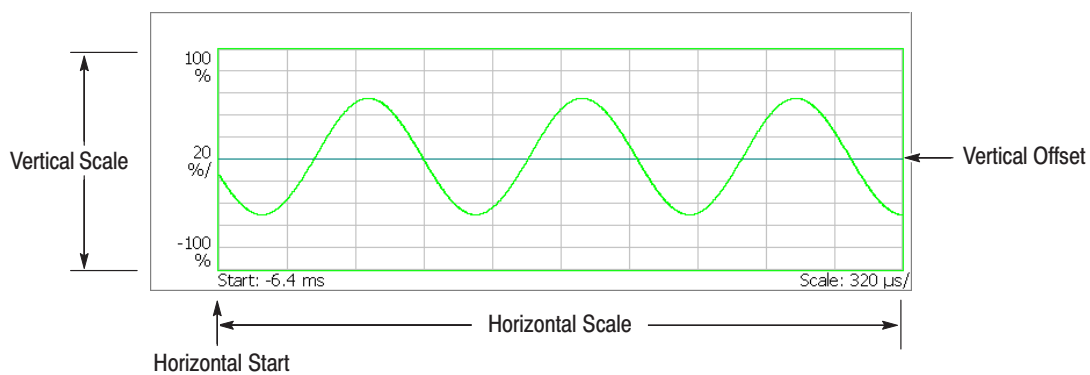
**Full Scale.** Sets the scale of the vertical axis to the default full-scale value.



Vertical axis: Power



Vertical axis: AM modulation factor, FM frequency deviation, PM phase deviation, or IQ level  
(AM modulation factor shown)



**Figure 3-91: Setting the scale in time domain view**

## CCDF View Setting

The CCDF view displays the CCDF measurement in the Digital Demod mode (digital modulation analysis, Option 21 only) and the Time mode (time analysis). The horizontal axis indicates amplitude and the vertical axis (logarithmic scale) indicates CCDF. Refer to page 3–48 for more information about the CCDF measurement.

### View: Scale Menu

The Scale menu for the CCDF view contains the following controls (see Figure 3–92):

**Auto Scale.** Sets the starting value and the scale of the vertical axis automatically to fit the waveform to the screen.

**Horizontal Scale.** Sets the range of the horizontal axis.

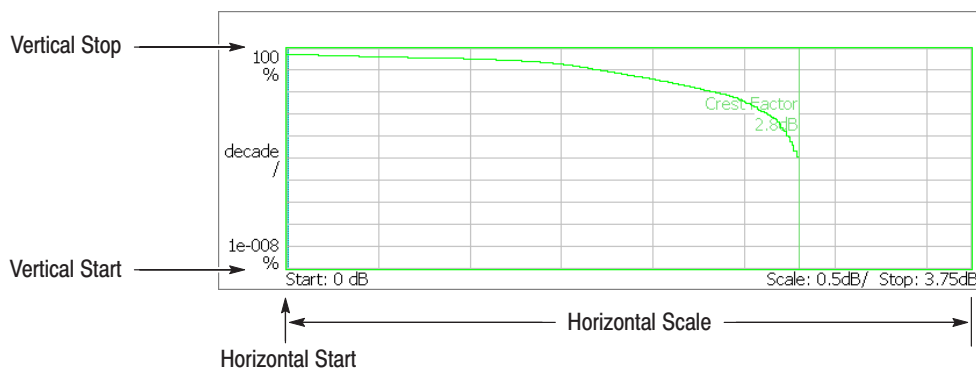
**Horizontal Start.** Sets the minimum value (left edge) of the horizontal axis.

**Vertical Stop.** Sets the maximum value (top) of the vertical axis.  
Range: Twice of Vertical Start value to 100% in a 1-2-5 sequence.

**Vertical Start.** Sets the minimum value (bottom) of the vertical axis.  
Range:  $10^{-9}$  to 1/2 of Vertical Stop value in a 1-2-5 sequence.

**Full Scale.** Sets the scale of the vertical axis to the default full-scale value.

**Sub Grid.** *Time mode only.* Determines whether to display the sub-grid.



**Figure 3–92: Setting the scale in CCDF view**

# Display Line

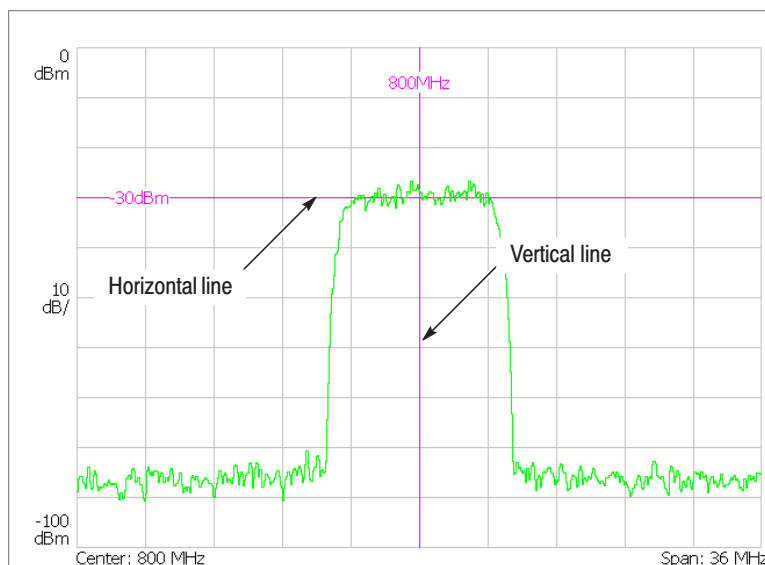
The analyzer provides a convenient method to determine whether a signal peak is higher or lower than a specified level, or whether it falls within a specified range. Use the LINES menu to control the display lines. The Display Line feature displays horizontal and/or vertical line(s) at the position you specify.

There are two types of lines: horizontal line and vertical line as shown in Figure 3–93. In the S/A mode other than Real Time S/A, you can display one or two of each line. You can display the horizontal and vertical lines concurrently. The Real Time S/A mode has multi display lines function that shows multiple horizontal and vertical lines.

---

**NOTE.** The display line is available only in the S/A (spectrum analysis) mode.

---



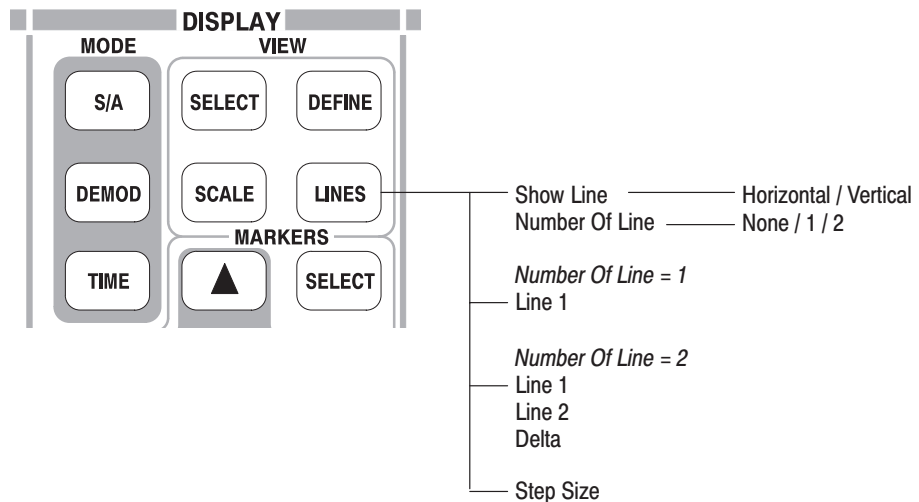
**Figure 3–93: Display line**

This section provides these two topics:

- Display Line Operation (Other than Real Time S/A)
- Multi Display Lines (Real Time S/A Only)

## Display Line Operation (Other than Real Time S/A)

Controls the display line. See Figure 3–94 for the Lines menu structure.



**Figure 3–94: Lines menu structure (other than Real Time S/A)**

### Lines Menu

The Lines menu in the S/A mode other than the Real Time S/A has the following controls:

**Show Line.** Selects the display line to be controlled:

- Horizontal
- Vertical

**Number Of Line.** Selects how many horizontal lines are displayed on the graph:

- None
- 1
- 2

**Line 1.** Sets the position of the first line.

**Line 2.** Sets the position of the second line.

**Delta.** Sets the difference between the first line and the second:  
 (Value of Line 2) – (Value of Line 1)

**Horizontal Display Line**

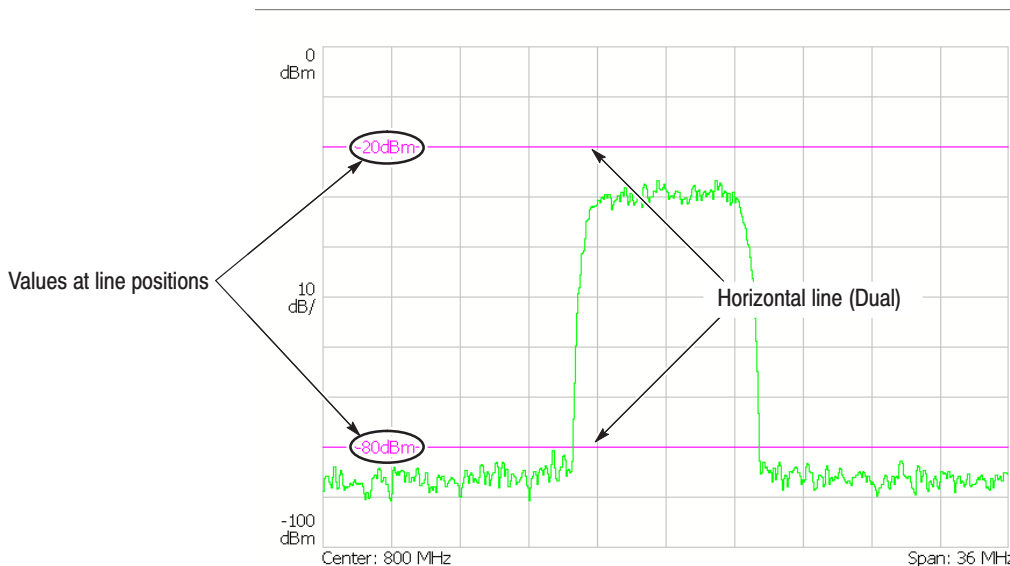
1. Press the **LINES** key on the front panel.
2. Press the **Show Line** side key to select **Horizontal**.

---

**NOTE.** In the following steps, use the general purpose knob or the numeric input keypad to move the lines.

---

3. Perform one of the following options.
  - *To display one horizontal line:*  
Press the **Number Of Line** side key to select **1**.  
  
Press the **Line 1** side key and move the line.
  - *To display two horizontal lines:*  
Press the **Number Of Line** side key to select **2**.  
  
Press the **Line 1** side key and move line 1. Line 2 moves in parallel.  
  
Press the **Line 2** side key and move line 2.  
  
Press the **Delta** side key and move line 2. The delta value indicates the following value: (value of Delta) = (value of line 2) – (value of line 1)
  - *To turn off the horizontal line:*  
Press the **Number Of Line** side key to select **None**.



**Figure 3-95: Two horizontal lines**

### Vertical Display Line

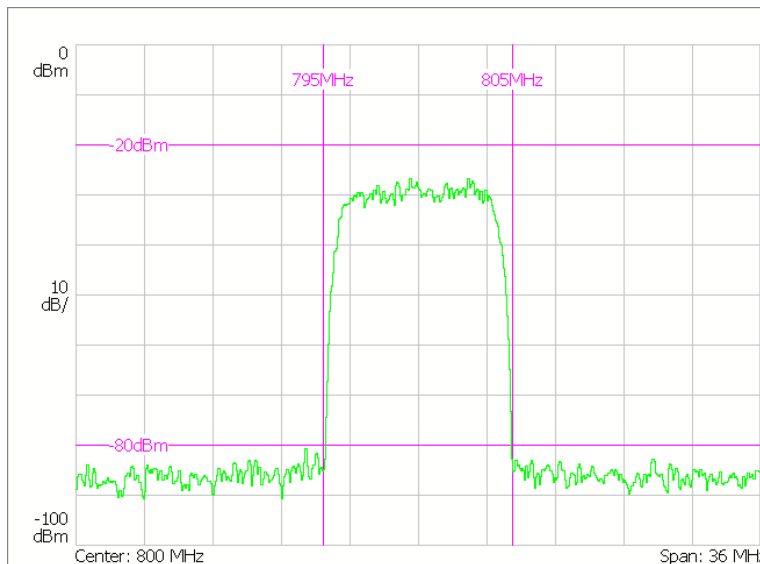
1. Press the **LINES** key on the front panel.
2. Press the **Show Line** side key to select **Vertical**.

---

**NOTE.** In the following steps, use the general purpose knob or the numeric input keypad to move the lines.

---

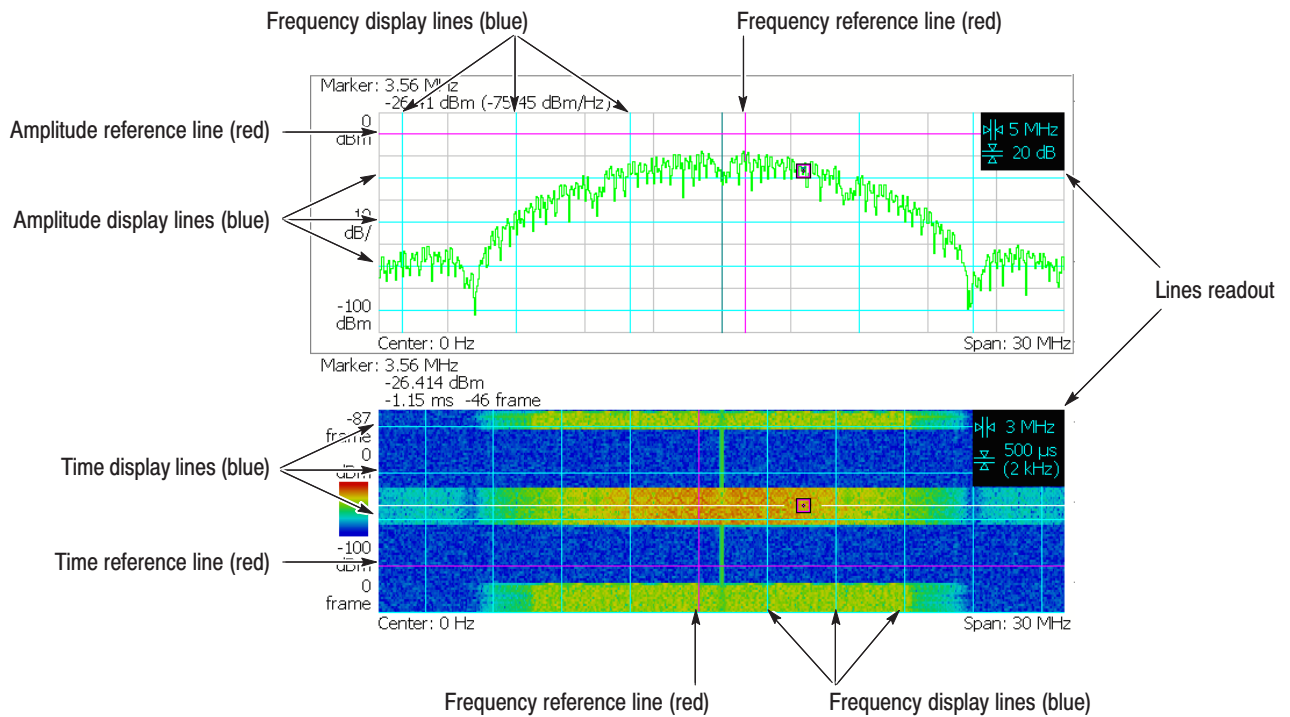
3. Perform one of the following options.
  - *To display one vertical line:*  
Press the **Number Of Line** side key to select **1**.  
  
Press the **Line 1** side key and move the line.
  - *To display two vertical lines:*  
Press the **Number Of Line** side key to select **2**.  
  
Press the **Line 1** side key and move line 1. Line 2 moves in parallel.  
  
Press the **Line 2** side key and move line 2.  
  
Press the **Delta** side key and move line 2. The delta value indicates the following value: (value of Delta) = (value of line 2) – (value of line 1)
  - *To turn off the vertical line:*  
Press the **Number Of Line** side key to select **None**.



**Figure 3-96: Two horizontal and two vertical lines**

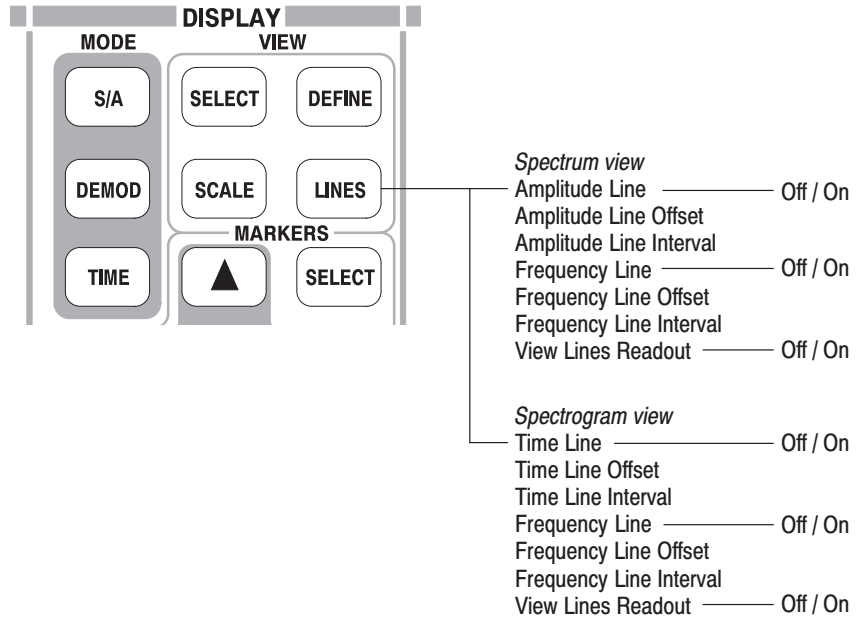
## Multi Display Lines (Real Time S/A Only)

The Real Time S/A mode has the multi display lines function that shows multiple horizontal and vertical lines as shown in Figure 3–97. The spectrum view uses the amplitude and frequency lines. The spectrogram uses the time and frequency lines. The display lines are placed at regular intervals from the reference line.



**Figure 3–97: Multi display lines (Real Time S/A mode)**

**Lines Menu** The Lines menu for the Real Time S/A mode has different controls between the spectrum and spectrogram view. The settings are shown in the lines readout at the upper right of the view (see Figure 3–97).



**Figure 3–98: Lines menu structure (Real Time S/A)**



**Spectrum View.**

**Amplitude Line.** Determines whether to turn on or off the amplitude display lines. The default is Off.

**Amplitude Line Offset.** Sets the offset of the amplitude reference line.  
Range: -100 to 0 dBm (the default is 0 dBm)

**Amplitude Line Interval.** Sets the interval of the amplitude display lines.  
Range: 0 to 100 dB (the default is 0 dB)

**Frequency Line.** Determines whether to turn on or off the frequency display lines. The default is Off.

**Frequency Line Offset.** Sets the offset of the frequency reference line.  
Range: Center frequency  $\pm$  Span/2 (Hz).  
The default value is the center frequency; the reference line is at center screen.

**Frequency Line Interval.** Sets the interval of the frequency display lines.  
Range: 0 to full span (the default is 0 Hz)

**View Lines Readout.** Determines whether to turn on or off the display lines readout. The default is On.

**Spectrogram View.**

**Time Line.** Determines whether to turn on or off the time display lines.  
The default is Off.

**Time Line Offset.** Sets the offset of the time reference line.  
Range: 0 second maximum (Zero represents the latest frame.)  
The minimum value depends on acquired data quantity.

**Time Line Interval.** Sets the interval of the time display lines.  
Range: 0 second minimum.  
The maximum value depends on acquired data quantity.

The other menu items (Frequency Line, Frequency Line Offset, Frequency Line Interval, and View Lines Readout) are the same as the spectrum view.



## Marker Operation and Peak Search

The marker moves on a waveform to measure amplitude or frequency. One or two markers can be displayed on the screen. You can also use the reference cursor together with the marker. The marker is also used for peak search. For information on the band power marker used in the spectrum analysis, refer to *Spectrum Analysis (S/A mode)* on page 3-1.

One or two markers (active and fixed) and/or a reference cursor can be displayed on the screen as shown in Figure 3-99.



**Figure 3-99: Marker display**

- **Single marker mode**  
One marker (called Marker 1) indicated by “□” moves on a waveform. It is used to measure absolute values.
- **Delta marker mode**  
Two markers (called Marker 1 and 2) indicated by “□” and “◇” move on a waveform. “□” and “◇” represent an active and a fixed marker, respectively. They are used to measure relative values.

## Markers Menu

The Markers menu controls the marker operation and peak search. Figure 3–100 shows the menu structure.

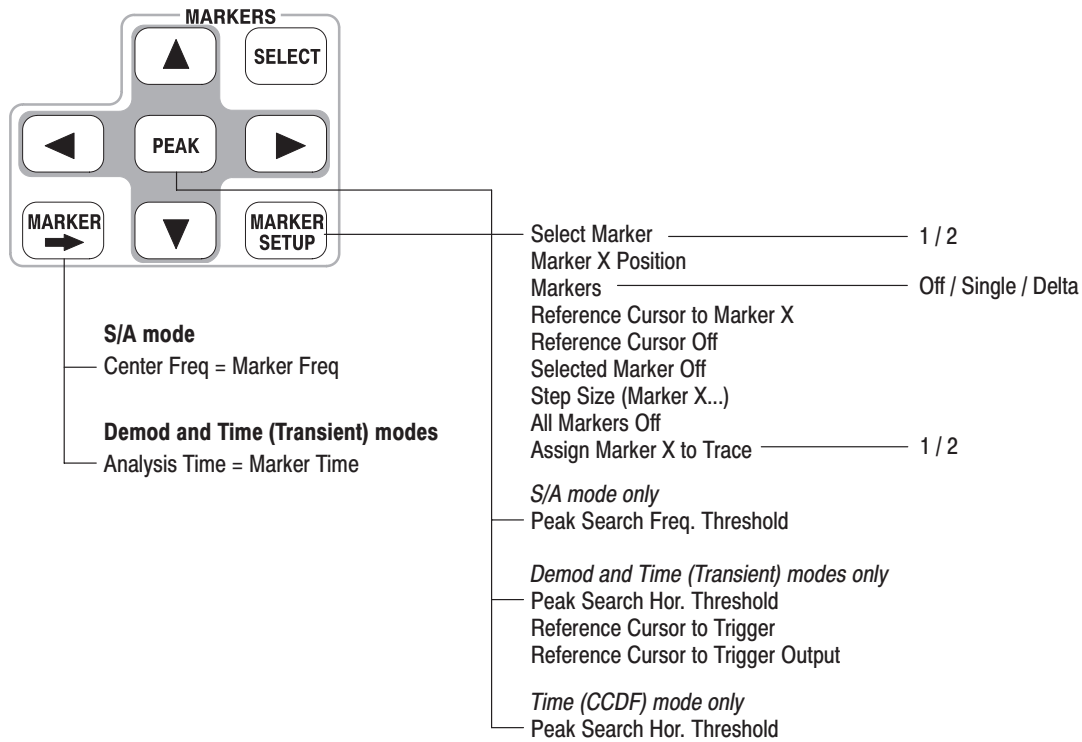


Figure 3–100: Markers menu structure

**SELECT**      Selects which marker is being controlled in the delta marker mode. If markers are disabled, pressing this key enables Marker 1.

**MARKER →**      Sets instrument parameters based on the marker position(s).  
**Center Freq = Marker Freq.** Changes the center frequency to match the current marker position.  
**Analysis Time = Marker Time.** *Demod and Time modes only.* Sets the origin of an analysis range with the marker in the overview. For the detail, refer to *Setting Analysis Range* on page 3–29.

**PEAK**      Positions the marker to the highest peak signal.

**Marker Left (◀)**      Moves the marker lower or higher in frequency to the next signal, respectively.  
**/ Right (▶)**

**Marker Up (▲)**      Moves the marker higher or lower in amplitude to the next signal, respectively.  
**/ Down (▼)**

The definition of “next” can be set in the Marker Setup menu, using Peak Search Freq. Threshold or Hor. Threshold. Refer to *Setting the Minimum Jump of the Marker* on page 3–149.

## MARKER SETUP

Set up the behavior of the markers.

**Select Marker.** Selects which marker is being controlled in the delta marker mode. Same as **MARKERS: SELECT**.

**Marker X Position.** Sets the horizontal position of the selected marker.

**Markers.** Selects the marker mode:

- **Off.** Displays no marker.
- **Single.** Displays one marker (Marker 1).
- **Delta.** Displays two markers (Marker 1 and 2).

**Reference Cursor to Marker X.** Enables the Reference Cursor, at the same position as the selected marker. Only available when the selected view can contain a reference cursor.

**Reference Cursor Off.** Turns off the Reference Cursor. Only available when the selected view can contain a reference marker.

**Selected Marker Off.** Turns off the selected marker.

**All Markers Off.** Turns off both markers, the reference cursor, and all their readouts.

**Assign Marker X to Trace.** When two traces are being displayed, moves the selected marker to another trace with the same horizontal position. Available only if two traces are being displayed.

**Peak Search Freq. Threshold.** *S/A mode only.* Sets the minimum frequency jump that should be made when selecting the next signal to the left/right/up/down.

**Peak Search Hor. Threshold.** *Demod and Time modes only.* Selects the minimum horizontal jump that should be made when selecting the next signal to the left/right/up/down.

**Marker X Vertical.** *Spectrogram view in the Real Time S/A mode only.* Specifies the number of the frame in the spectrogram to display the spectrum. The latest frame is number zero. Older frames have larger negative numbers. Same as Spectrum Offset in the Timing menu.

**Reference Cursor to Trigger.** *Demod and Time modes only.* Enables the reference cursor at the same position as the trigger in the overview.

**Reference Cursor to Trigger Output.** *Demod and Time modes only.* Enables the reference cursor at the same position as the trigger output in the overview.

## Using Markers

This section shows some examples of marker operation.

**NOTE.** If multiple views are displayed on the screen, select the view to operate the markers using the **VIEW: SELECT** key on the front panel. The selected view is shown with a white frame.

### Measuring with a Single Marker

To measure amplitude or frequency with a single marker, follow these steps:

1. Press the **MAKER SETUP** key on the front panel.
2. Press the **Makers** side key to select **Single**. Only Marker 1 is enabled.

Note that the **Marker X Position** menu item is already selected.

3. Rotate the general purpose knob (or enter the value using the numeric keypad) to move the marker to the measurement location.

The marker readout is displayed in the top left portion of the screen (see Figure 3–101).

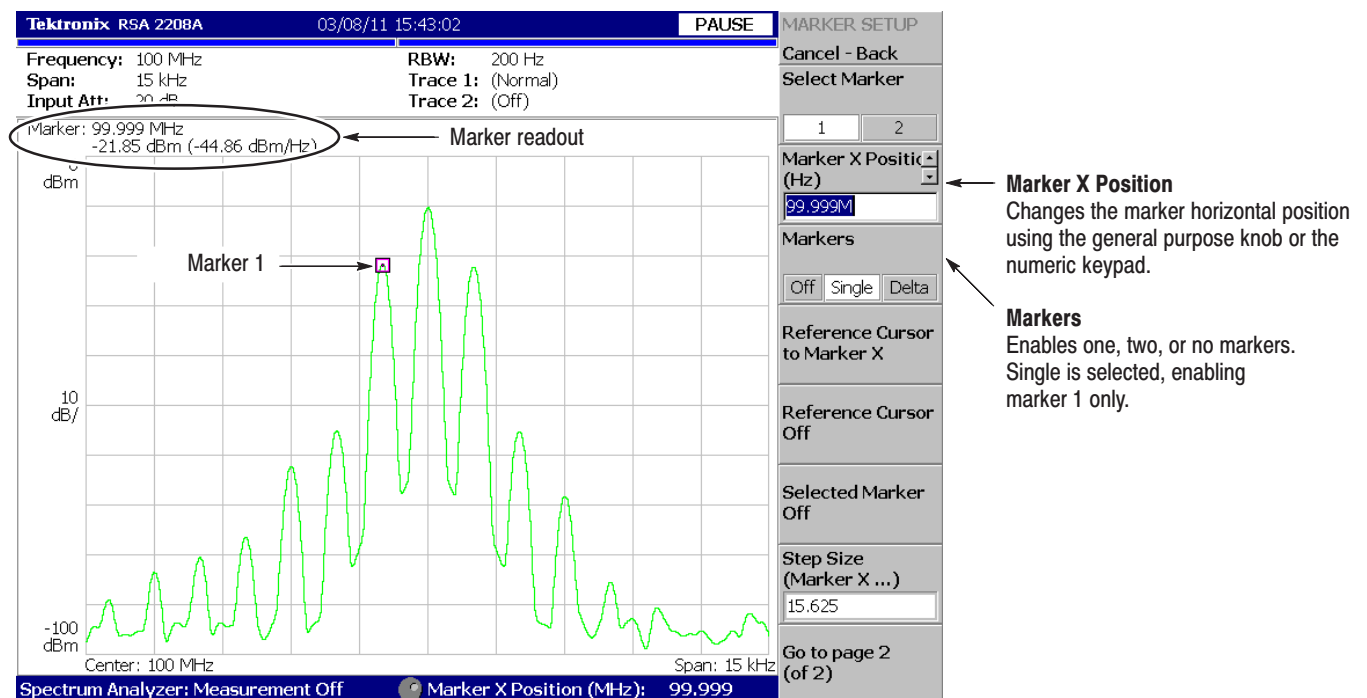


Figure 3–101: Measurement with a single marker

### Measuring with the Delta Marker

To measure differences in amplitudes or frequencies using the delta marker, follow these steps:

1. Press the **MAKER SETUP** key on the front panel.
2. Press the **Makers** side key to select **Delta**.

Marker 1 and 2 are displayed, with the two markers overlapping each other. **Select Marker** is set to **1** (Marker 1) by default.

Note that the **Marker X Position** menu item is already selected.

3. Rotate the general purpose knob (or enter the value using the keypad) to move the active marker to the reference point.
4. Change the active marker by pressing the **Select Marker** side key to select **2**.
5. Rotate the general purpose knob (or enter the value using the keypad) to move the active marker to the measurement point.

As shown in Figure 3–102, the marker readout is shown in the top left portion of the screen:

$$(\text{Delta marker readout}) = (\text{Marker 1 readout}) - (\text{Marker 2 readout})$$

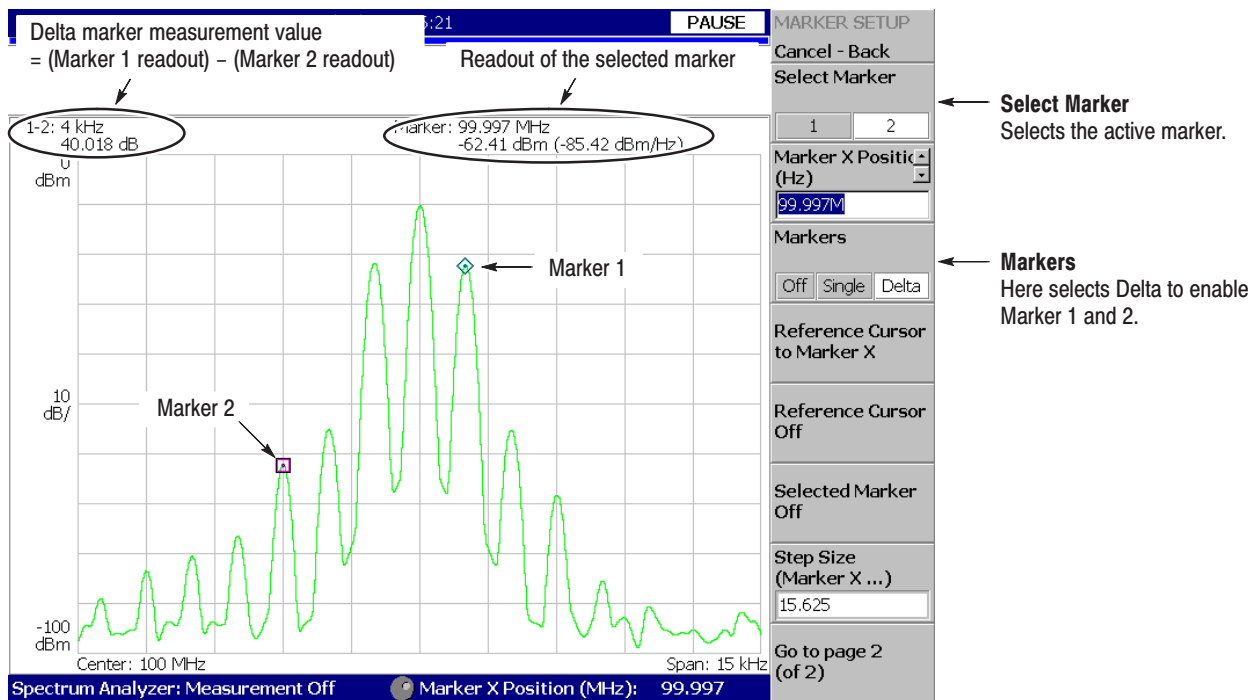


Figure 3–102: Using the delta marker to take measurements





As shown in Figure 3–103, the marker readout relative to the reference cursor is shown in the top left portion of the screen for the active marker selected using the **Select Marker** side key.

To turn off the reference cursor, press the **Reference Cursor Off** side key.

### Changing the Trace

Use the following steps to change the trace on which you operate the marker when displaying two traces on a view. Trace 1 is displayed in yellow and Trace 2 in green.

In the S/A (spectrum analysis) mode, two traces are shown when Trace 2 is turned on using the TRACE/AVG menu.

In DEMOD (modulation analysis) mode and TIME (time analysis) mode, two traces are shown in IQ vs. Time view (I level vs. time and Q level vs. time).

1. Press the **MAKER SETUP** key on the front panel.
2. Press the **Go to page 2 (of 2)** (bottom) side key to show the next menu page.
3. Press the **Assign Marker X to Trace** side key to select Trace 1 or 2, as shown in Figure 3–104.

The marker moves to another trace with the same horizontal position.

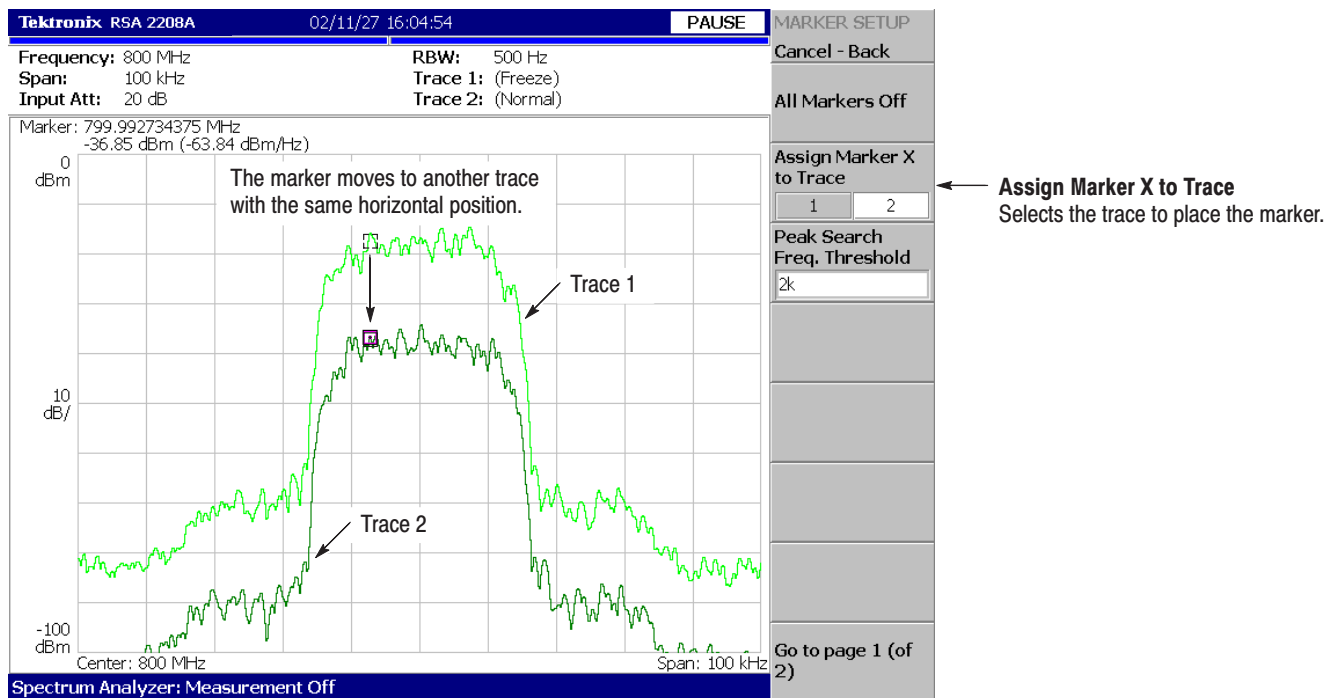
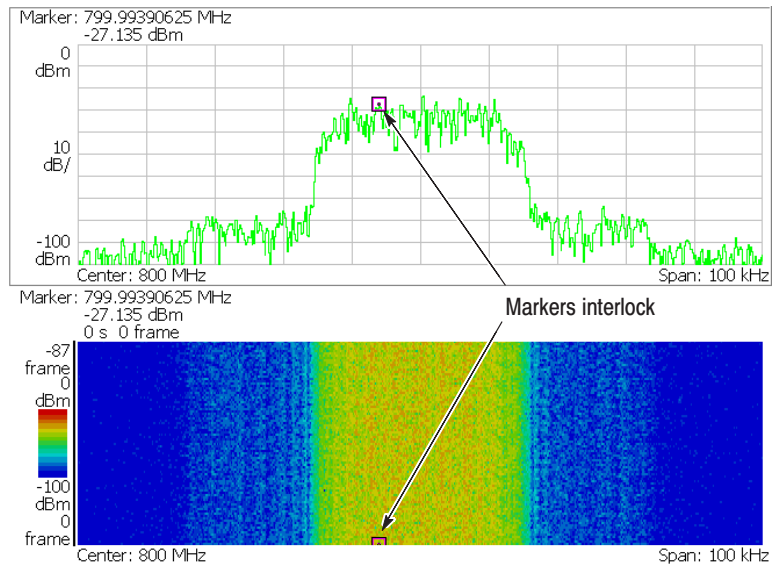


Figure 3–104: Changing the Trace

**Markers in Multiple Views**

When you display multiple views on one screen, markers displayed in those views are locked together.

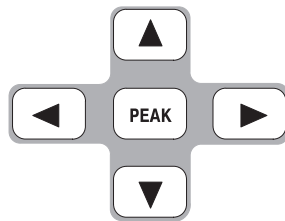
Figure 3–105 shows a concurrent display of the spectrum and the spectrogram. If you move the marker to the left on the spectrum, the marker on the spectrogram moves to the left in accordance with that movement. Conversely, if you move the marker on the spectrogram to the left, the marker on the spectrum moves to the left.



**Figure 3–105: Interlocked markers**

## Peak Search

The peak search function searches for the peak on the waveform and moves the marker to the peak position. Use the **PEAK** and marker left/right/up/down (◀▶▲▼) keys on the front panel for peak search.



### Using the Peak Search keys

The peak search keys have the following functions (see Figure 3–106):

**PEAK** Positions the marker to the highest peak signal.

◀ Moves the marker lower in frequency to the next signal.

▶ Moves the marker higher in frequency to the next signal.

▲ Moves the marker higher in amplitude to the next signal.

▼ Moves the marker lower in amplitude to the next signal.

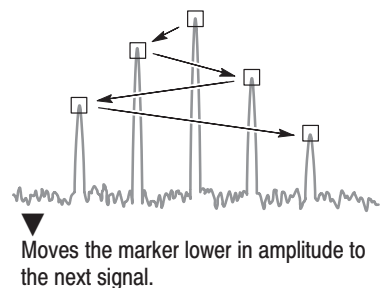
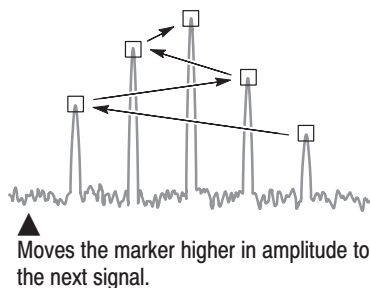
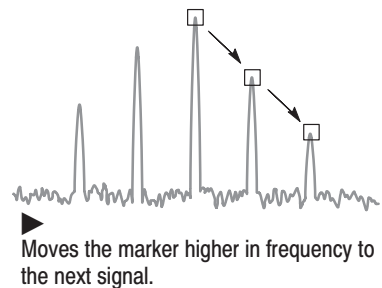
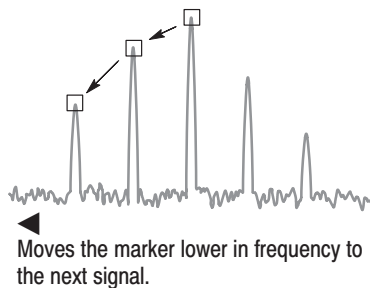
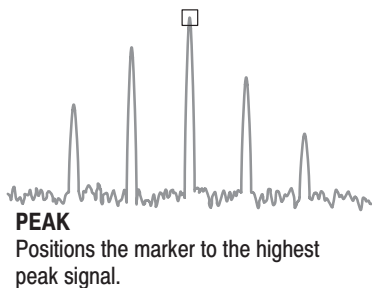


Figure 3–106: Functions of the peak search keys

### Setting the Minimum Jump of the Marker

The definition of “next” can be set in the Marker Setup menu using the following parameters:

**Peak Search Freq. Threshold.** *S/A mode only.*

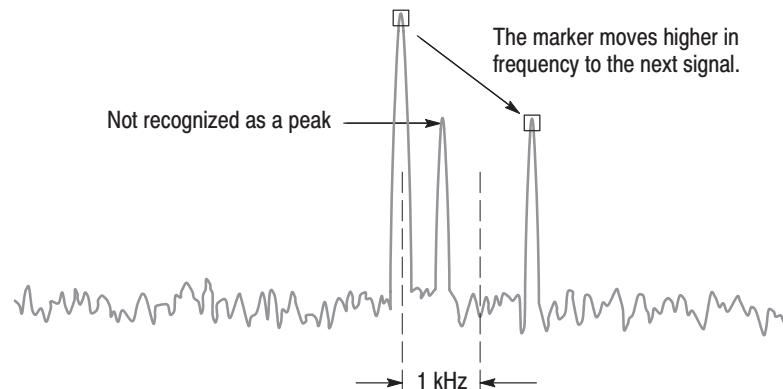
Sets the minimum frequency jump that will be made when selecting the next signal to the left/right/up/down.

**Peak Search Hor. Threshold.** *Demod and Time modes only.*

Sets the minimum horizontal jump that will be made when selecting the next signal to the left/right/up/down.

For example, when Peak Search Freq. Threshold is set to 1 kHz, the next peak is recognized only if it is 1 kHz or more distant from the first peak (see Figure 3–107).

Example: Peak Search Freq. Threshold = 1 kHz



**Figure 3–107: Setting the minimum frequency jump**

Use the following steps to set the minimum jump:

1. Press the **MAKER SETUP** key on the front panel.
2. Press the **Go to page 2 (of 2)** (bottom) side key to show the next menu page.
3. Press either of the following side keys depending on the measurement mode and then set the minimum jump:
  - **Peak Search Freq. Threshold** in the S/A mode
  - **Peak Search Hor. Threshold** in the Demod and Time modes



# Using the Online Help

This section describes the analyzer help system and how to access it.

The online help system is integrated as part of the analyzer user interface, using the Windows help system. You can use the front-panel arrow keys (as in the following procedure), a mouse, or a keyboard to navigate through the help system. See page 3–154 for information about using a mouse or keyboard to navigate through the online help.

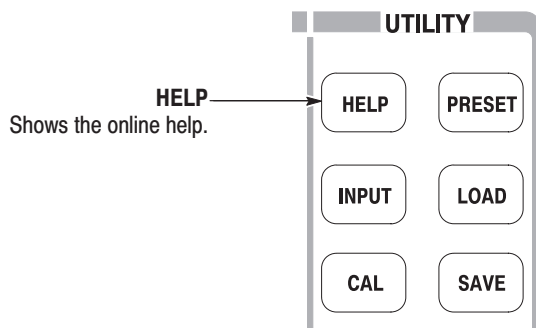
The help system provides information about operating this analyzer, providing the following help resources online:

- Front-panel key descriptions
- Online user manual
- Online programmer manual

## Displaying the Online Help

Use the following procedure to show the online help:

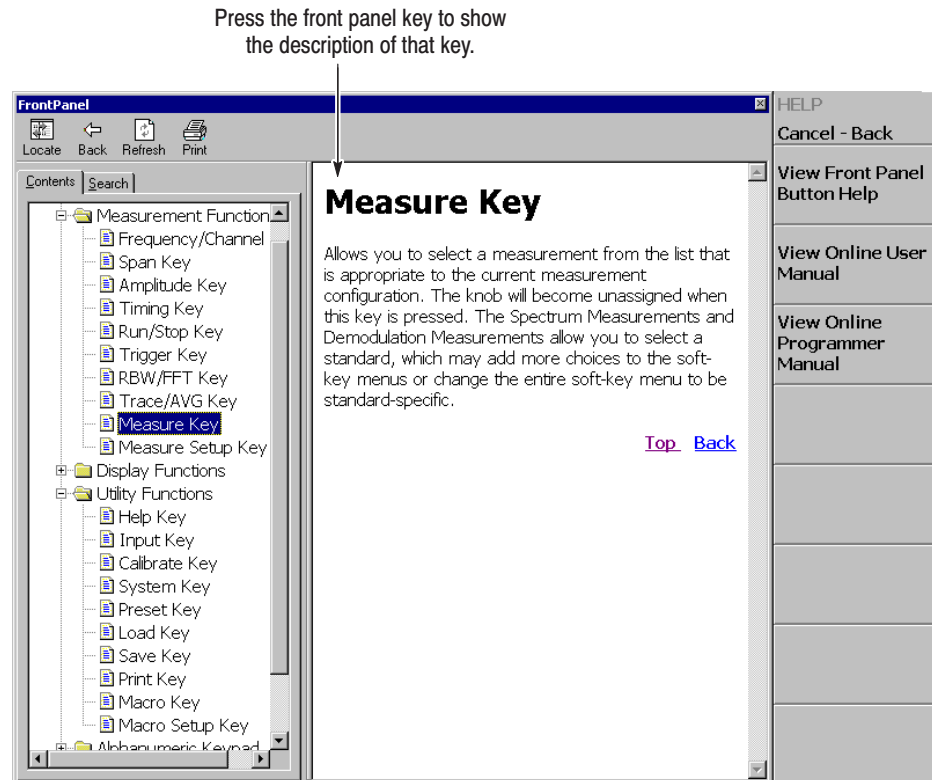
1. Press the **HELP** key on the front panel.



2. Select the type of online help using the side keys:
  - **View Front Panel Button Help.** Provides descriptions of the front-panel keys.
  - **View Online User Manual.** Displays the analyzer user manual, formatted for online use.
  - **View Online Programmer Manual.** Displays the analyzer programmer manual, formatted for online use.

3. Depending on the type of online manual you selected, use one of the following two procedures:

- If you selected *View Front Panel Button Help*: Press the front-panel key about which you want to receive information. For example, press the **MEASURE** key to show information about that key (see Figure 3–108).



**Figure 3–108: Online help for the front panel key**

- If you selected *View Online User Manual* or *View Online Programmer Manual*: Using the front panel keys listed in Table 3–14, select the topic from the contents window on screen (see Figure 3–109). The key functions are different in the contents (left) window than in the descriptions (right) window.



Table 3-14: Front panel keys for online help

Front panel key	Function	
	Contents window	Descriptions window
General purpose knob	Selects a topic.	Scrolls the display up or down.
Up key (▲)	Selects a topic on top in the window.	Scrolls the display up.
Down key (▼)	Selects a topic on bottom in the window.	Scrolls the display down.
MARKERS: ▲	Selects the next topic up.	Scrolls the display up.
MARKERS: ▼	Selects the next topic down.	Scrolls the display down.
MARKERS: ◀	Moves to the next level up.	Scrolls the display to the left.
MARKERS: ▶	Moves to the next level down.	Scrolls the display to the right.
PEAK	Switch the window to operate the cursor.	
MARKER ➔	-	Selects a character string with hyperlink.
BKSP	Moves to the next level up.	Returns to the previous display.
ENTER	Accepts the selection and displays the corresponding content.	

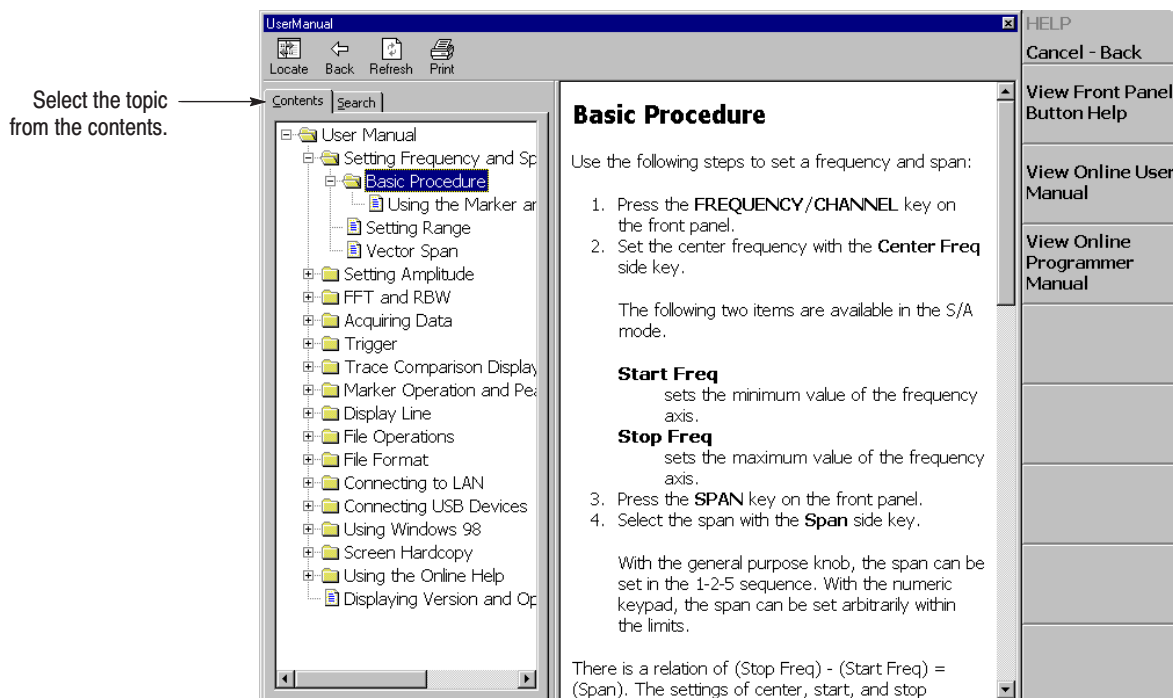


Figure 3-109: Online user manual

4. To exit the help system, press the **Cancel-Back** (top) side key.

## Using a Mouse and Keyboard

You can control the help system using a mouse and a keyboard instead of the front panel keys. Using a mouse, click the topic in the contents window to show the description. Using a keyboard, select a topic or enter a search word (see Figure 3–110). Use the arrow keys to move the cursor, and the enter key to accept the selection.

Refer to *Side Panel* on page 2–5 on connecting a USB mouse and keyboard to the analyzer.

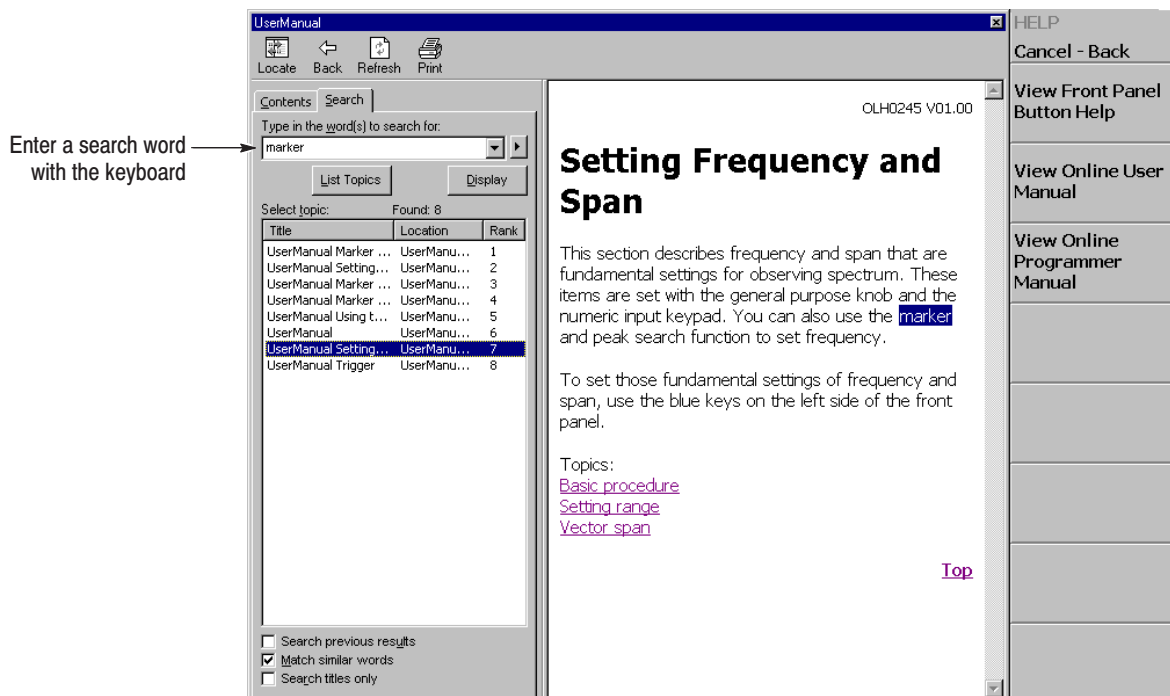


Figure 3–110: Word search using the keyboard

# Selecting Input Source

You can select from two input sources in the Input menu: RF and Cal.

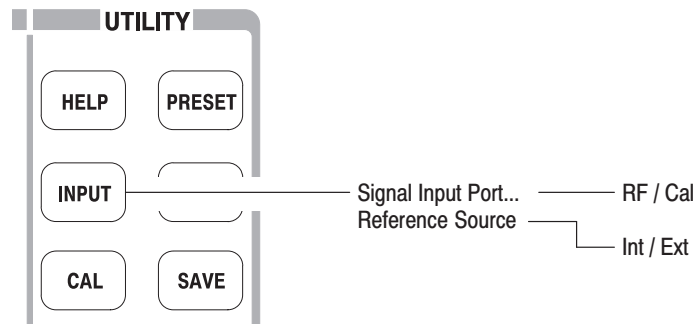


Figure 3-111: Input menu tree

## Input Menu

The Input menu contains the following controls:

**Signal Input Port...** Selects which input is used for signal connection.

- **RF.** *Default.* Uses the signal from the INPUT connector on the front panel. See Figure 2-1 on page 2-2 for the front panel connectors.
- **Cal.** Uses the internal 50 MHz calibration signal as the signal source. Refer to *Functional Check* on page 1-14 for using the cal signal to check the system performance.

**Reference Source.** Selects the source for reference frequency.

- **Int.** Uses the internal clock (10 MHz simulated sine wave).
- **Ext.** Uses the 10 MHz sine wave of -10 to +6 dBm from the REF IN connector on the rear panel when you want to synchronize the analyzer with other instrument(s).

The reference clock is available from the REF OUT connector on the rear panel.



# File Operations

The instrument settings and waveform data can be saved in or loaded from files on the hard disk or 3.5 inch disk. This section describes how to handle files, containing the following topics:

- File Type
- Load/Save Menu
- Saving and Loading Files
- Entering a File Name
- Deleting a File
- Making/Deleting a Directory

## File Type

The analyzer can make files with the following extensions:

- **.STA** (Status file)  
A status file used to save all the current menu settings. You can save the settings you frequently use and reset the analyzer any time by loading the settings from this file.
- **.IQT** (Data file)  
A file used to save time-domain waveform data acquired on the data memory in the Demod (Modulation Analysis) and the Time (Time Analysis) modes. I, Q, and T stand for in-phase, quadrature phase, and time domain, respectively.
- **.TRC** (Trace file)  
A file used to save Trace 1 or 2 in the S/A (Spectrum Analysis) mode. The data in this file is loaded as the reference waveform in comparison displays between Trace 1 and 2, for example.
- **.COR** (Amplitude correction file)  
A file used in the S/A (Spectrum Analysis) mode to save an amplitude correction table. The data in this file is loaded when the amplitude correction is performed. Refer to page 3–76 for the amplitude correction.

## Load/Save Menu

Figure 3–112 shows the Load/Save menu structure.

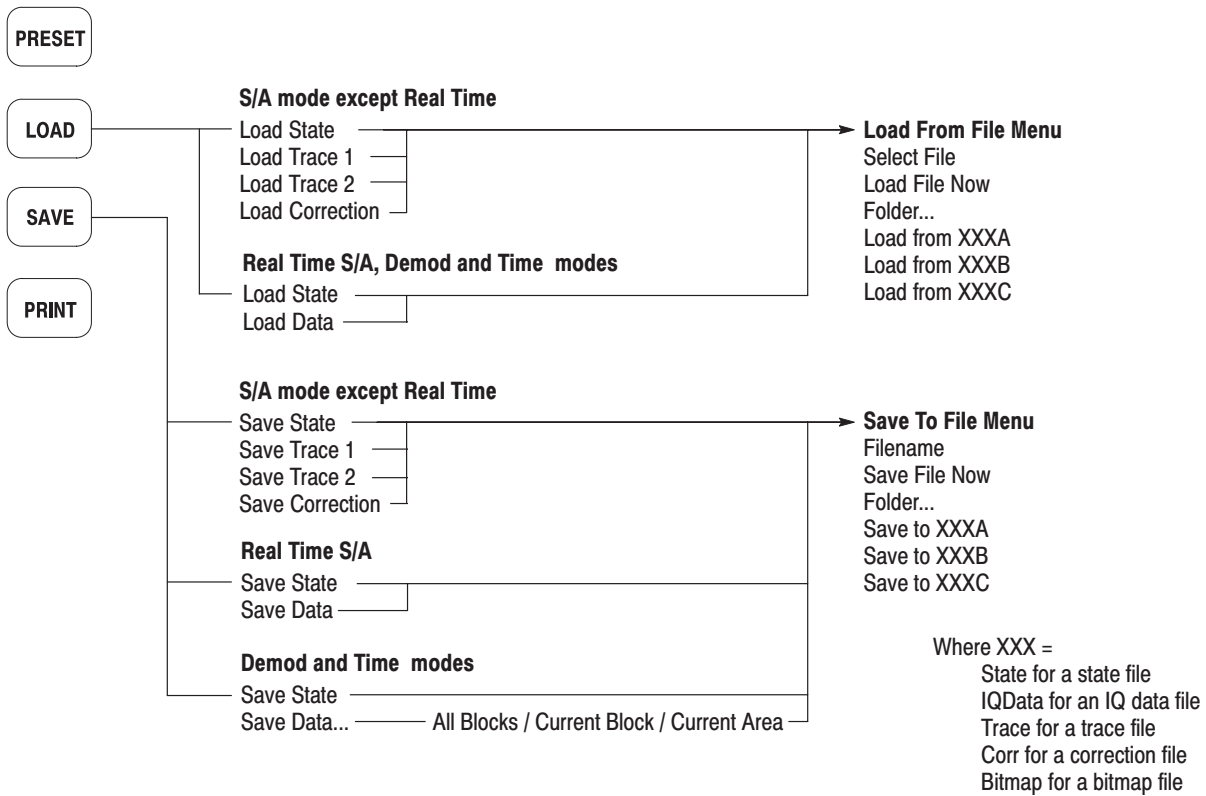


Figure 3–112: Load/Save menu structure

---

**Load Menu** Loads waveform data or instrument settings from a file.

**Load State.** Loads the instrument settings.

**Load Data.** *Real Time S/A, Demod, and Time modes only.* Loads waveform data (IQ data in the time domain).

---

**NOTE.** *The menu items below (Load Trace 1, Load Trace 2, and Correction) are available in the S/A mode except Real Time S/A.*

---

**Load Trace 1.** Loads data for Trace 1 of a graph.

**Load Trace 2.** Loads data for Trace 2 of a graph.

**Load Correction.** Loads a correction table of Frequency/Amplitude pairs used for adjusting amplitude values.

**Save Menu** Saves waveform data or instrument settings to a file.

**Save State.** Saves the instrument settings.

**Save Data.** *Real Time S/A only.* Saves waveform (IQ data in the time domain).

**Save Data...** *Demod and Time modes only.* Saves waveform data (IQ data in the time domain) specified with the following submenu:

- **All Blocks.** Saves all the blocks.
- **Current Block.** Saves the block currently displayed.
- **Current Area.** Saves the data displayed in the main view.

---

**NOTE.** *The menu items below (Save Trace 1, Save Trace 2, and Correction) are available in the S/A (spectrum analysis) mode except Real Time S/A.*

---

**Save Trace 1.** Saves data for Trace 1 of a graph.

**Save Trace 2.** Saves data for Trace 2 of a graph.

**Save Correction.** Saves a correction table of Frequency/Amplitude pairs used for adjusting amplitude values.

## Saving and Loading Files

The following procedures show how to save and load files.

**Using a Disk** You can use a 2HD (1.44 M bytes) or 2DD (720 K bytes) 3.5-inch disk formatted for MS-DOS. The disk drive is on the side panel. See Figure 2–3 on page 2–5.

**Saving a File** Use the following steps to save settings or waveforms to a file. There are two ways to save data to a file: using the preset file name and entering a new file name. To return to the previous menu, press the **Cancel - Back** side key at any time.

---

**NOTE.** *You cannot save data in an existing file.*

---

1. Press the **SAVE** key on the front panel.
2. Press one of the following side keys, depending on the type of data to save:

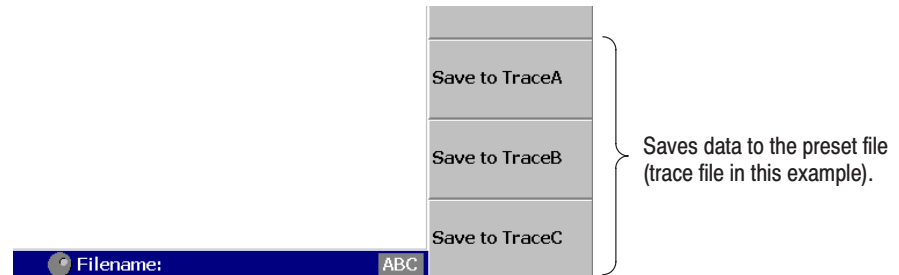
**Table 3–15: File save operation**

Meas. mode	Side key	Save content	Ext.
S/A (except Real Time)	Save State	Current instrument settings	.sta
	Save Trace 1	Trace 1 waveform	.trc
	Save Trace 2	Trace 2 waveform	.trc
	Save Correction	Amplitude correction data	.cor
Real Time S/A	Save State	Current instrument settings	.sta
	Save Data	Acquired data in time domain	.iqt
Demod / Time	Save State	Current instrument settings	.sta
	Save Data...	Acquired data in time domain	.iqt
	All Blocks	Data of all blocks	
	Current Block	Data of the block currently displayed	
	Current Area	Data currently shown in the main view	

3. To enter a new file name, skip to step 5.



4. To use a preset file name, press the **Save to file name** side key (see Figure 3–113 as an example).



**Figure 3–113: Save to the preset file (lower right of the screen)**

There are three preset names for each file type as shown in Table 3–16.

**Table 3–16: Preset file names**

File type	Save file name
State (.sta)	StateA, StateB, StateC
Data (.iqt)	IQDataA, IQDataB, IQDataC
Trace (.trc)	TraceA, TraceB, TraceC
Correction (.cor)	CorrA, CorrB, CorrC

The data is saved to the file with that name in the C:\My Documents folder. The file extension is automatically added according to the file type.

5. To enter a new file name:
  - a. Press the **Folder...** side key.
  - b. Select the destination folder using the following menu items (see Figure 3–114):
    - **+Open Folder** opens the selected folder.
    - **Select Folder** selects a folder.
    - **-Close Folder** closes the selected folder.
    - **Done** accepts the selected file.

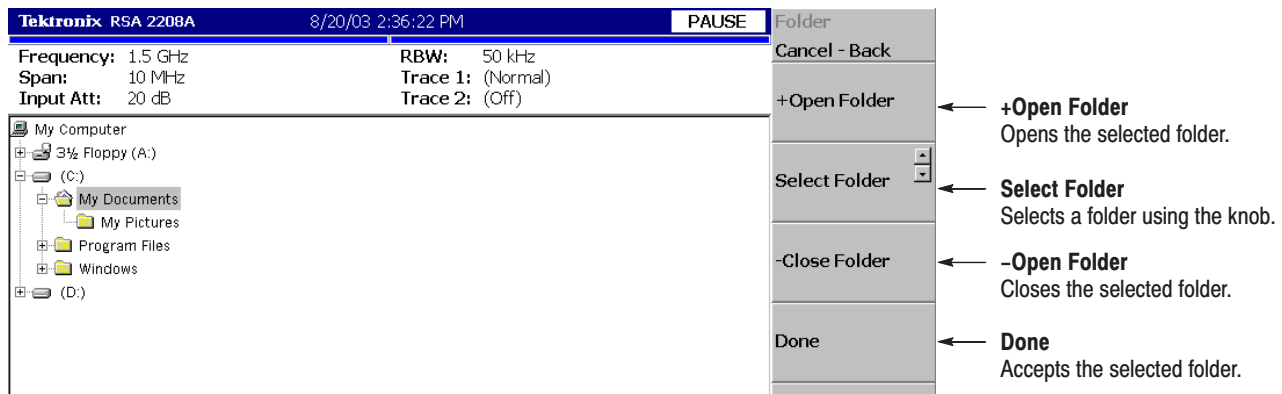


Figure 3–114: Selecting the folder

- c. After selecting the folder, press the **Done** side key to accept it. The list of files in the selected folder appears, displaying only files with the same extension as the file to be stored.

- d. Press the **Filename** side key (see Figure 3–115) and enter a file name using the front-panel keypad. The file extension is automatically added. Refer to *Entering a File Name* on page 3–166 for details about how to enter the name.

Here, input “TRACE1” for example, using the front-panel keypad.

- Press the **TUV** (number **2**) key once to select the letter “T” and then press the **ENTER** key.
  - Press the **PQRS** (number **1**) key three times to select the letter “R” and then press the **ENTER** key.
  - Press the **ABC** (number **8**) key once to select the letter “A” and then press the **ENTER** key.
  - Press the **ABC** (number **8**) key three times to select the letter “C” and then press the **ENTER** key.
  - Press the **DEF** (number **9**) key twice to select the letter “E” and then press the **ENTER** key.
  - Press the **PQRS** (number **1**) key five times to select the letter “1” and then press the **ENTER** key.
- e. After entering the file name, press the **Save File Now** side key.

The data is saved to the specified file.

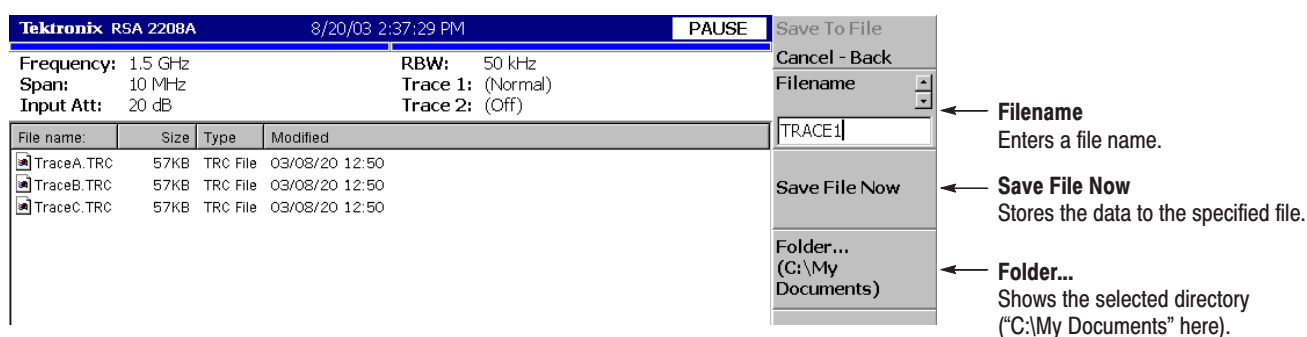


Figure 3–115: Save to File menu

**Loading a File**

Use the following steps to load settings or waveform from a file. There are two ways to load data from a file: selecting the preset file and selecting a file by name. When you want to return to the previous menu, press the **Cancel - Back** side key at any time.

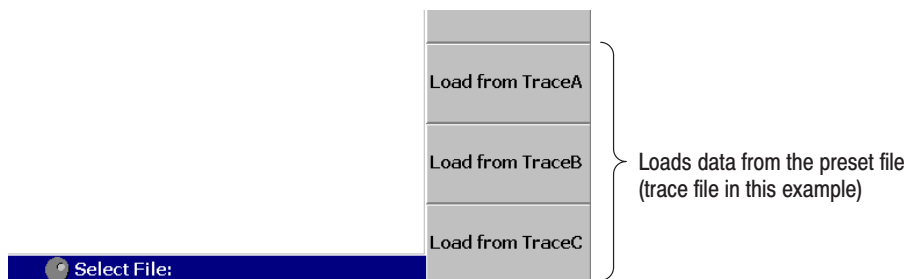
1. Press the **LOAD** key on the front panel.
2. Press one of the following side keys according to the type of data to load:

**Table 3-17: File load operation**

Meas. mode	Side key	Load content	Ext.
S/A (except Real Time)	Load State	Instrument settings	.sta
	Load Trace 1	Trace 1 waveform	.trc
	Load Trace 2	Trace 2 waveform	.trc
	Load Correction	Amplitude correction data	.cor
Real Time S/A, Demod or Time	Load State	Instrument settings	.sta
	Load Data	Acquired data in time domain	.iqt

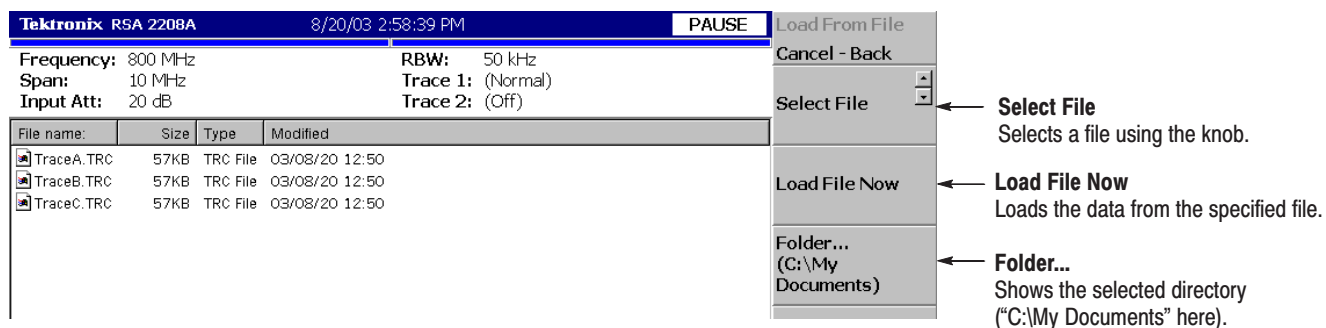
3. To select a file by name, skip to step 5.
4. To select the preset file to which you have saved data in step 4 on page 3-161, press the **Load from file name** to load the data (see Figure 3-116 as an example). The file extension is automatically added according to the file type.

**NOTE.** If you have not saved any data to the preset file that you select, the error message “File name not found” appears on the bottom left of the screen.



**Figure 3-116: Load from the preset file (lower right of the screen)**

5. To select an existing file, press the **Folder...** side key. Select the folder containing the file to be loaded. (For a file select procedure, see step 5 on page 3–162.)
6. After selecting the folder, press the **Done** side key to accept it.  
The list of files in the selected folder appears.
7. Press the **Select File** side key and then select the file from the list using the general purpose knob.
8. After selecting the file, press the **Load File Now** side key. See Figure 3–117.  
The data is loaded from the specified file.



**Figure 3–117: Load from File menu**

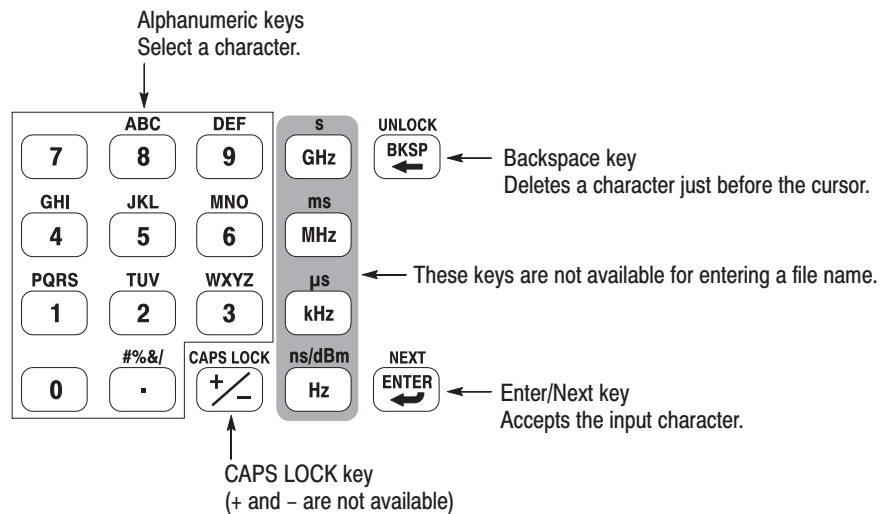
**NOTE.** In the Real Time S/A, the Demod, and the Time modes, when you abort data acquisition before it is completed, such as in a trigger-armed state, the last data block is empty. Therefore, when you save all the blocks to a file and then load the file, the waveform does not appear at first. If you have acquired multiple blocks, select an old block to display the waveform.

## Entering a File Name

When you select the file or the directory from the list, the file name or the directory name is displayed in the upper part of the screen.

Use the keypad on the front panel to input a file name (see Figure 3–118).

- **0 to 9** and **“.”** keys are used to enter alphabetic characters, numbers, punctuation and special characters indicated above each key. For example, the **8** key inputs A, B, and C, as well as 8. Each time you press the key, the selected character moves through the list: A → B → C → 8 ...
- **CAPS LOCK** key toggles a character between uppercase and lowercase.
- **BKSP** (backspace) key deletes the character just before the cursor.
- **ENTER/NEXT** key accepts the input character.

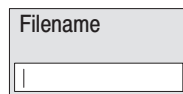


**Figure 3–118: Alphanumeric keypad**

**Procedure** To enter a new name, SAMPLE1, use the following steps:

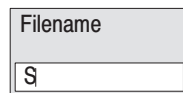
1. Press the **Filename** side key.

The cursor appears on the left end in the text box.



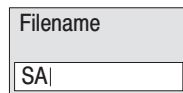
A screenshot of a device's interface showing a text box labeled "Filename". The text box is empty, and a vertical cursor is positioned at the left end of the box.

2. Press the **PQRS** key on the keypad four times to enter "S".



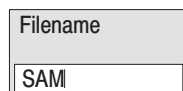
A screenshot of the device's interface showing the "Filename" text box. The character "S" has been entered into the text box, and the cursor is now at the end of the character.

3. Press the **ABC** key on the keypad once to enter "A".



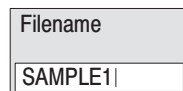
A screenshot of the device's interface showing the "Filename" text box. The characters "SA" have been entered into the text box, and the cursor is at the end of the second character.

4. Press the **MNO** key on the keypad once to enter "M".



A screenshot of the device's interface showing the "Filename" text box. The characters "SAM" have been entered into the text box, and the cursor is at the end of the third character.

5. Enter the remaining characters in the same way.



A screenshot of the device's interface showing the "Filename" text box. The characters "SAMPLE1" have been entered into the text box, and the cursor is at the end of the final character.

If you make a mistake, you can correct it any time before pressing the **Enter** side key by repeatedly pressing **BKSP** (the backspace key) until the incorrect character disappears and then typing the correct value. If you want to restart from the beginning, press the **Cancel - Back** (top) side key. You can also move the insertion cursor using the general purpose knob or up/down keys.

## **Deleting a File**

You can delete a file using Windows, but not using the analyzer menu. Refer to page 2–26 for information about using Windows on the analyzer. Refer to Windows documentation for additional information about operating Windows.

## **Making/Deleting a Directory**

You can make or delete a directory using Windows, but not using the analyzer menu. Refer to page 2–26 for information about using Windows on the analyzer. Refer to Windows documentation for additional information about operating Windows.



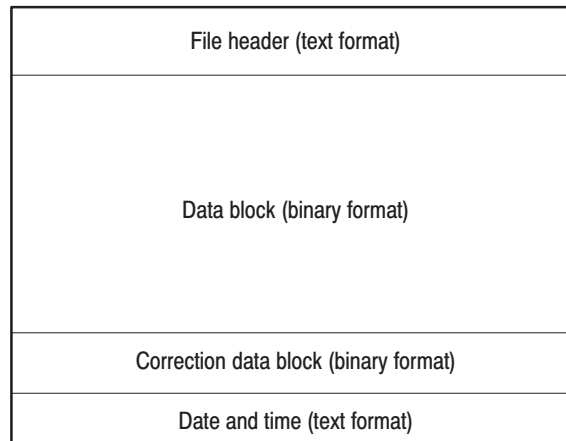
# File Format

This section describes the structure of the data file (\*.IQT) and the trace file (\*.TRC).

## Data File Format

**File Structure** The data file normally consists of five blocks. The date and time may be added to the end for data logging (see Figure 3–119).

Data file (\*.IQT)



**Figure 3–119: Data file structure**

The file is normally created after data acquisition is complete. When logging data is acquired continuously, a data block is added each time the data is acquired.

In data logging, since the internal program adds data blocks while acquiring data, when the program creates the file header, the date and time for the last frame is not known. The program, therefore, adds date and time data to the end of the file. If you examine the file size and find the date and time at the end, use them in place of DateTime in the file header. Refer to DateTime on page 3–172 for the format of date and time.

The number of frames ValidFrames (refer to page 3–172) is not known at the time the program creates the file header, so the internal program temporarily writes ValidFrames=0. If the value of ValidFrames of the file header is 0, examine the file size and calculate the true value of ValidFrames. In this case, the correction data block, the dummy header, and the extended correction data block are always added.

The subsections below provide details on each block.

### File Header

The following is an example of the file header. Although Type is always written at the beginning, the order of the other items is not fixed and some new items may be added.

```
40416Type=WCA380IQT (NOTE: not RSA2208AIQT but WCA380IQT)
FrameReverse=Off
FramePadding=Before
Band=RF3
MemoryMode=Zoom
FFTPoints=1024
Bins=801
MaxInputLevel=0
LevelOffset=0
CenterFrequency=7.9G
FrequencyOffset=0
Span=5M
BlockSize=40
ValidFrames=40
FramePeriod=160u
UnitPeriod=160u
FrameLength=160u
DateTime=2002/05/10@13:21:16
GainOffset=-82.3326910626668
MultiFrames=1
MultiAddr=0
IOffset=-0.0475921630859375
QOffset=0.12628173828125
```

The first character “4” indicates that the number of bytes of the file header is expressed with four characters after the second character.

In the preceding example:

Number of bytes of the file header = 1 + 4 + 0416 = 421

The number of bytes is therefore 421. Data starts from the 422<sup>nd</sup> byte.

**Type.** Shows the type of data. In the RSA2200A series, only this type is used:

- **WCA380IQT.** The data block contains I and Q values in the time domain.

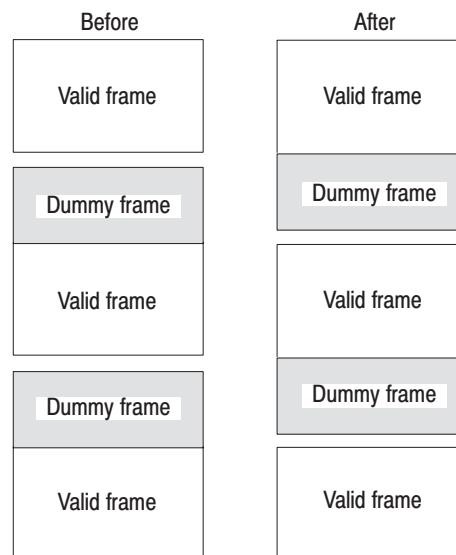
This type is called WCA380IQT for compatibility with the \*.IQT file of the WCA300 series.

**FrameReverse.** Shows the frame order. This item is always Off in the RSA2200A series. The following parameters are provided:

- **Off.** Frames are stored in the order of acquisition. The last frame in the data block is the latest acquired frame.
- **On.** Frames are stored in the reverse order of acquisition. The first frame in the data block is the latest acquired frame.

**FramePadding.** The analyzer adds dummy frames when acquired frames do not fill BlockSize (block size). Figure 3–120 shows the dummy frames. The FramePadding parameter is always set to Before in the RSA2200A series.

- **Before.** Adds dummy frames before valid frames, but not in the first block.
- **After.** Adds dummy frames after valid frames, but not in the last block.



**Figure 3–120: Adding dummy frames**

**Band.** Shows the frequency band that was set when the analyzer acquired the data. It is necessary only when the analyzer reloads the data.

**MemoryMode.** Shows the memory mode that was set when the analyzer acquired the data. It is necessary only when the analyzer reloads the data.

**FFTPoints.** Shows the FFT point setting that was set when the analyzer acquired the data. This item is always 1024 in the RSA2200A series.

**Bins.** Shows the number of bins. The same value is also entered in *bins* of each frame header of the data block (refer to *Frame Header* on page 3–173).

**MaxInputLevel.** Shows the reference level setting in dBm when the analyzer acquired the data.

**LevelOffset.** Shows the level offset setting in dB when the analyzer acquired the data.

**CenterFrequency.** Shows the center frequency setting in Hz when the analyzer acquired the data.

**FrequencyOffset.** Shows the frequency offset setting in Hz when the analyzer acquired the data.

**Span.** Shows the span setting in Hz when the analyzer acquired the data.

**BlockSize.** Shows the block size setting when the analyzer acquired the data.

**ValidFrames.** Shows the number of frames in the data block. This value divided by MultiFrames represents the number of frames that are scanned and synthesized into one frame.

**FramePeriod.** Shows the frame period setting in seconds. The actual period is obtained by multiplying UnitPeriod (described below) by the difference of time stamp ticks of each frame in the data block.

**UnitPeriod.** Shows the unit time in seconds of time stamp Ticks of each frame in the data block.

**FrameLength.** Shows the time in second necessary to acquire one frame.

**DateTime.** Shows the time when the analyzer acquired the last frame in a data block. Change “@” to “ ” (space) for display because files may have many “@” characters.

**GainOffset.** Shows the gain offset. It is used for calculating the amplitude (refer to page 3–175).

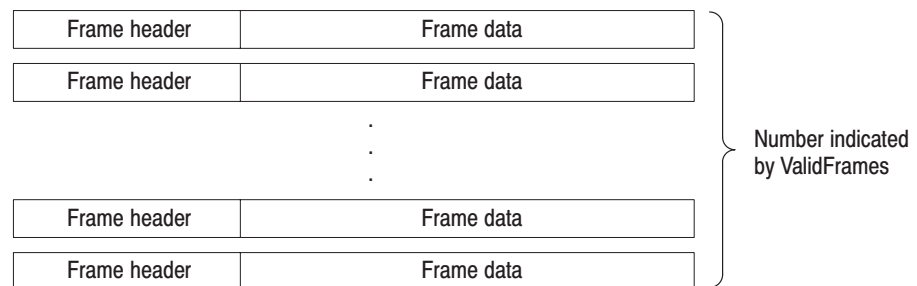
**MultiFrames.** Shows the number of frames in multi-frame mode. For example, when MultiFrames = 20, scanning 20 times with a span of 5 MHz makes a span of 100 MHz.

**MultiAddr.** Shows the last frame address in the multi-frame mode. The range is 0 to MultiFrames –1. MultiFrames –1 indicates that the data ends just at the end of scans.

**IOffset.** Shows the offset value of I data. It is used for calculating the data value (refer to page 3–175).

**QOffset.** Shows the offset value of Q data. It is used for calculating the data value (refer to page 3–175).

**Data Block** Each data block contains several pairs of frame header and frame data (see Figure 3–121). The number of pairs in a block is indicated by ValidFrames in the file header. The frame order is determined by FrameReverse in the file header.



**Figure 3–121: Data block**

**Frame Header** The frame header is defined by the following structure:

```
struct frameHeader_st {
    short reserved1;
    short validA;
    short validP;
    short validI;
    short validQ;
    short bins;
    short reserved2;
    short triggered;
    short overLoad;
    short lastFrame;
    unsigned long ticks;
};
```

Descriptions of the frame header items follow.

**short reserved1.** Internal use only.

**short validA, validP, validI, validQ.** These parameters indicate whether data of amplitude, phase, I or Q (value converted into a two-byte signed integer) is written.

- **0.** Indicates that data is not written in the file.
- **-1.** Indicates that data is written in the file.

There are seven combinations as listed in Table 3–18.

**Table 3–18: Combinations of validA, P, I and Q**

validA	validP	validI	validQ
0	0	0	0
-1	0	0	0
0	-1	0	0
-1	-1	0	0
0	0	-1	0
0	0	0	-1
0	0	-1	-1

**short bins.** Shows the number of bins. It is the same as Bins in the file header.

**short reserved2.** Internal use only.

**short triggered.** Indicates whether the frame is before or after the trigger.

- **0.** Indicates that the frame is before the trigger (pre-trigger).
- **-1.** Indicates that the frame is after the trigger (post-trigger).

**short overLoad.** Indicates whether an input overload occurred.

- **0.** Indicates that the MaxInputLevel value in the file header was correct.
- **-1.** Indicates that the MaxInputLevel value in the file header was too low.

**short lastFrame.** The analyzer can divide its memory into (100 frames) × (40 blocks), for example. LastFrame indicates the last frame in a block.

- **0.** Indicates that the frame is not the last in the block.
- **-1.** Indicates that the frame is the last in the block.

**unsigned long ticks.** Shows a time stamp using UnitPeriod in the file header (not FramePeriod) as a unit time.

**Frame Data** A frame contains 1024 pairs of I and Q data in the time domain in order of data acquisition.

**Definition of Bin.** The bin is defined by the following structure:

```
struct iqBin_st {
    short q;
    short i;
};
```

**Definition of Frame.** The frame is defined by the following structure:

```
struct iqFrame1024_st {
    struct iqBin_st iq[1024];
};
```

**Calculation of Data** All the data of amplitude, phase, I and Q are transformed to 2-byte signed integers, and then written in the file.

**Amplitude.** The amplitude is calculated using i and q in the IQT file using these formulas:

$$i = i - \text{IOffset}$$

$$q = q - \text{QOffset}$$

$$\text{Amplitude} = 10 * \ln(i * i + q * q) / \ln(10) + \text{GainOffset} + \text{MaxInputLevel} + \text{LevelOffset} [\text{dBm}]$$

**Phase.** The phase is calculated using i and q in the IQT file using these formulas:

$$i = i - \text{IOffset}$$

$$q = q - \text{QOffset}$$

$$\text{Phase} = \text{atan2}(q, i) * (180 / \text{Pi}) [\text{degree}]$$

**I, Q.** I and Q are calculated using i and q in the IQT file using these formulas.

$$i = i - \text{IOffset}$$

$$q = q - \text{QOffset}$$

$$\text{IQScale} = \text{Sqrt}(\text{Power}(10, (\text{GainOffset} + \text{MaxInputLevel} + \text{LevelOffset}) / 10) / 20 * 2)$$

$$I = i * \text{IQScale} [\text{V}]$$

$$Q = q * \text{IQScale} [\text{V}]$$

**Correction Data Block**

The correction data block contains gain and phase correction data as one frame of data block in the frequency domain. When this block is added, the amplitude and phase are calculated using the following formulas. Be careful about the sign for phase correction.

$$\text{Amplitude} = (\text{Original data}) - (\text{Gain correction data}/128) \text{ [dBm]}$$

$$\text{Phase} = (\text{Original data}) + (\text{Phase correction data}/128) \text{ [degree]}$$

**Definition of Bin.** The bin is defined by the following structure:

```
struct apBin_st {  
    short a;  
    short p;  
};
```

**Definition of Frame.** The frame is defined by the following structure:

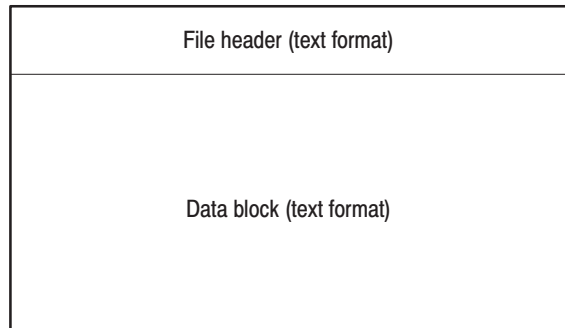
```
struct apFrame1024_st {  
    struct apBin_st ap[1024];  
};
```



## Trace File Format

**File Structure** The trace file consists of two blocks in the text format. Figure 3–122 shows the structure and Figure 3–123 shows an example of a trace file.

Trace file (\*.TRC)



**Figure 3–122: Trace file structure**

```

# XNum=641
# XRightLabel=Span
# XStart=1.9995G
# XScale=1.0015625M
# XUnit=Hz
# ZNum=1
# YStart=-100
# XLeftLabel=Center
# UpdateAreas=1
# YUnit=dBm
# NBW=3.13180146596413k
# YMiddleUnit=dB
# YScale=100
# UpdatePosition=640
-100.875531204    0
-111.253515034   0
-101.342080442   0
-96.7588947616  0
-98.5946571418  0
-101.68696219   0
-97.8503895777  0
-100.806522438  0
-100.274828469  0
-95.8906131833  0
-97.9340093534  0
-101.366985559  0
...

```

The text is annotated with curly braces on the right side. The top brace, labeled 'File header', encompasses the lines from '# XNum=641' to '# UpdatePosition=640'. The bottom brace, labeled 'Data block', encompasses the lines from '-100.875531204 0' to '-101.366985559 0'.

**Figure 3–123: Trace file example**

**File Header** The following is an example of the file header:

```
# XNum=641
# XRightLabel=Span
# XStart=1.9995G
# XScale=1.0015625M
# XUnit=Hz
# ZNum=1
# YStart=-100
# XLeftLabel=Center
# UpdateAreas=1
# YUnit=dBm
# NBW=3.13180146596413k
# YMiddleUnit=dB
# YScale=100
# UpdatePosition=640
```

Descriptions of the file header items follow.

“*Required*” means that the item is prerequisite for displaying waveform.

**XNum.** *Required.* Represents the number of data in the data block.

**XRightLabel.** Represents the label displayed on the right of the horizontal axis: Span (span) when XLeftLabel is Center (center frequency), or Stop (stop frequency) when XLeftLabel is Start (start frequency).

**XStart.** *Required.* Represents the minimum (left) edge of the horizontal axis.

**XScale.** *Required.* Represents the scale of the horizontal axis.

**XUnit.** Represents the unit of the horizontal axis: fixed to Hz.

**ZNum.** *Required.* Internal use only: fixed to 1.

**YStart.** *Required.* Represents the minimum (bottom) edge of the vertical axis.

**XLeftLabel.** Represents the label on the left of the horizontal axis: Center (center frequency) when XLeftLabel is Span (span), or Start (start frequency) when XLeftLabel is Stop (stop frequency).

**UpdateAreas.** Internal use only.

**YUnit.** Represents the unit of the vertical axis: dBm, dB $\mu$ V, V, or W.

**NBW.** Specifies NBW (Noise Bandwidth) when setting FFT parameters, or RBW (Resolution Bandwidth) when setting RBW parameters.

**YMiddleUnit.** Represents the unit of the vertical axis scale. Specify dB when YUnit is dBm. For all other values of YUnit, the YUnit value is used.

**YScale.** *Required.* Represents the scale of the vertical axis.

**UpdatePosition.** Internal use only.

**Data Block** Pairs of a power value and a mask value are written in order, with a tab between the power and the mask (see Figure 3–124). The number of lines is indicated by XNum in the file header.

Power 1	(tab)	Mask 1	}	Number indicated by XNum
Power 2	(tab)	Mask 2		
Power 3	(tab)	Mask 3		
.				
.				
Power N	(tab)	Mask N		

**Figure 3–124: Data block**

Part of the data block might look like this:

–100.875531204	0
–111.253515034	0
–101.342080442	0
–96.7588947616	0
–98.5946571418	0
...	

For example, the first line indicates that the power is –100.875531204 dBm and the mask value is 0.

**Mask Value.** The mask value represents whether to display the data.

- **0.** Indicates that the data is displayed.
- **–1.** Indicates that the data is not displayed.



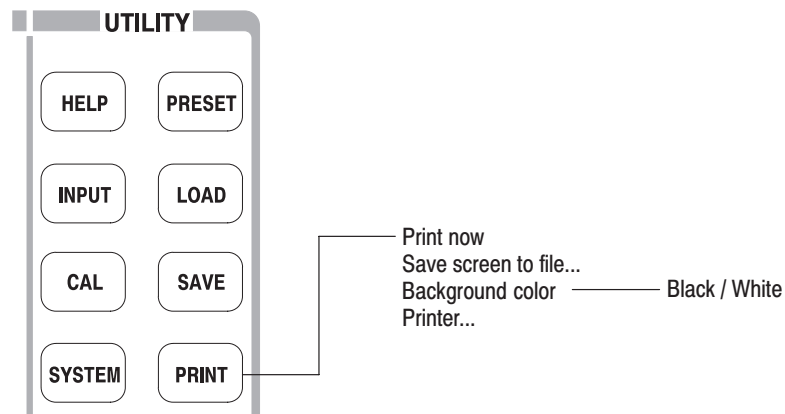
# Screen Copy

This section explains how to send a screen copy to a printer or a file. Use a printer that complies with USB specifications. For files, data in the bitmap format (.BMP) are created. The following topics are described in this section:

- Print Menu
- Printing a Screen Copy
- Creating a File

## Print Menu

The Print menu contains the following controls:



**Figure 3-125: Print menu structure**

**Print now.** Starts printing a copy of the analyzer screen to an attached printer.

**Save screen to file...** Opens the Save menu to save a bitmap file. For file operations, refer to page 3-157.

**Background color.** Selects the background color for printing.

- **Black.** Prints the background of screen in black.
- **White.** Reverses the background of screen to white.

**Printer...** Selects a destination printer.

## Printing a Screen Copy

You must connect the USB printer to the analyzer and install the printer driver before you can print.

### Connecting a Printer

Connect the USB cable of the printer to the USB port on the side panel of the analyzer. You can use either of two ports. Refer to *Side Panel* on page 2–5 for connecting the USB devices.

If the analyzer is connected to a network through a LAN interface, you can also use a network printer.

### Installing Printer Driver

Install the printer driver using the Windows XP printer wizard. Refer to the printer manual for the installation method. Refer to page 2–26 for using Windows XP.

### Print

To print a copy of the analyzer screen, follow these steps:

1. Press the **PRINT** key on the front panel, and select **Black** or **White** as the background color with the **Background color** side key.
2. Display the measurement to be printed and stop data acquisition.
3. Press the **PRINT** key again. The screen image data is captured on the internal memory with the background color set in step 1.
4. Press the **Printer...** side key and select a destination printer.
5. Press the **Print now** side key to start printing.

If the printer driver displays a message during printing, follow the instructions.

## Creating a File

You can save a screen image to a file as bitmap data and read the data into a word processor to create a report, for example.

To save the file to a floppy disk, insert it to the floppy disk drive.

1. Press the **PRINT** key on the front panel, and select **Black** or **White** of the background color with the **Background color** side key.
2. Display the measurement to be copied and stop data acquisition.
3. Press the **PRINT** key again. The screen image data is captured on the internal memory with the background color set in step 1.
4. Press the **Save screen to file...** side key. The file selection screen appears.
5. Do one of the following to output the screen image to a specified file:
  - *Using a preset file name:* Press the **Save to BitmapA**, **Save to BitmapB**, or **Save to BitmapC** side key. The image data is stored to the file *BitmapA.bmp*, *BitmapB.bmp*, or *BitmapC.bmp* in the *C:\My Documents* folder, respectively.
  - *Entering a new file name:* Enter a file name with the **Filename** side key, referring to *Entering a File Name* on page 3–166. The file extension **.BMP** is automatically assigned. When you have finished entering the name, press the **Save File Now** side key to store the copy in the file.

After the screen copy is saved in the file, the screen returns to the original waveform display.





# Appendices



# Appendix A: Specifications

This appendix lists the electrical, physical, and environmental characteristics of the analyzer, and specifies the performance requirements for those characteristics. The specifications are common to RSA2203A and RSA2208A, unless otherwise noted.

Unless otherwise stated, the following tables of electrical characteristics and features apply to the analyzer after a 20 minute warm-up period (within the environmental limits) and after all calibration procedures have been carried out.

## Electrical Characteristics

**Table A-1: Frequency**

Characteristics	Description
Measurement frequency	
Frequency range	RF: 10 MHz to 3 GHz (RSA2203A) RF1: 10 MHz to 3.5 GHz (RSA2208A) RF2: 3.5 GHz to 6.5 GHz (RSA2208A) RF3: 5 GHz to 8 GHz (RSA2208A) Baseband: DC to 20 MHz (Option 05)
Center frequency setting resolution	0.1 Hz
Frequency marker readout accuracy (RF, RF1 to 3, and baseband (Option 05))	$\pm(\text{RE} \times \text{MF} + 0.001 \times \text{Span} + \text{RFM})$ Hz RE: Reference frequency error; MF: Marker frequency; RFM: Residual FM
At specified frequency: Standard	RF/RF1, Frequency = 2 GHz, Span = 1 MHz Marker: $\pm 5$ kHz; Carrier frequency measurement: $\pm 4$ kHz RF2, Frequency = 5 GHz, Span = 1 MHz (RSA2208A only) Marker: $\pm 11$ kHz; Carrier frequency measurement: $\pm 10$ kHz RF3, Frequency = 7 GHz, Span = 1 MHz (RSA2208A only) Marker: $\pm 15$ kHz; Carrier frequency measurement: $\pm 14$ kHz
At specified frequency: Option 05	Frequency = 10 MHz, Span = 1 MHz, without Option 10 Marker: $\pm 1$ kHz; Carrier frequency measurement: $\pm 50$ Hz Frequency = 10 MHz, Span = 1 MHz, with Option 10 Marker: $\pm 1$ kHz; Carrier frequency measurement: $\pm 1.2$ Hz
At specified frequency: Option 10	RF/RF1, Frequency = 2 GHz, Span = 1 MHz Marker: $\pm 1.2$ kHz; Carrier frequency measurement: $\pm 210$ Hz RF2, Frequency = 5 GHz, Span = 1 MHz (RSA2208A only) Marker: $\pm 1.5$ kHz; Carrier frequency measurement: $\pm 510$ Hz RF3, Frequency = 7 GHz, Span = 1 MHz (RSA2208A only) Marker: $\pm 1.7$ kHz; Carrier frequency measurement: $\pm 710$ Hz
Residual FM ( <i>Typical</i> )	10 Hz p-p (standard); 2 Hz p-p (Option 10)
Span accuracy	$\pm 1$ bin
RBW filter bandwidth accuracy	0.1%
Reference frequency	
Aging per year ( <i>Typical</i> )	$2 \times 10^{-6}$ ; $1 \times 10^{-7}$ (Option 10)
Temperature drift (10 to 40 °C)	$2 \times 10^{-6}$ ; $1 \times 10^{-7}$ (Option 10)
Total frequency error (within one year after calibration)	$4 \times 10^{-6}$ ; $2 \times 10^{-7}$ (Option 10)
Reference output level	>0 dBm
External reference input	10 MHz, -10 to +6 dBm, Spurious level <-80 dBc within 100 kHz offset

**Table A-2: Spectrum purity**

Characteristics	Description
Spectrum purity (Frequency = 1500 MHz)	
Carrier offset = 10 kHz, Span = 100 kHz	100 dBc/Hz
Carrier offset = 100 kHz, Span = 1 MHz	105 dBc/Hz
Carrier offset = 1 MHz, Span = 5 MHz	125 dBc/Hz

**Table A-3: Noise sideband**

Characteristics	Description	
	Noise sideband	Offset
Frequency = 1000 MHz	-99 dBc/Hz -105 dBc/Hz -105 dBc/Hz -105 dBc/Hz -112 dBc/Hz -130 dBc/Hz -132 dBc/Hz -133 dBc/Hz	1 kHz 10 kHz 20 kHz 30 kHz 100 kHz 1 MHz 5 MHz 7 MHz
Frequency = 2000 MHz	-95 dBc/Hz -104 dBc/Hz -105 dBc/Hz -105 dBc/Hz -112 dBc/Hz -130 dBc/Hz -132 dBc/Hz -132 dBc/Hz	1 kHz 10 kHz 20 kHz 30 kHz 100 kHz 1 MHz 5 MHz 7 MHz
Frequency = 6000 MHz (RSA2208A only)	-87 dBc/Hz -103 dBc/Hz -103 dBc/Hz -105 dBc/Hz -111 dBc/Hz -128 dBc/Hz -129 dBc/Hz -130 dBc/Hz	1 kHz 10 kHz 20 kHz 30 kHz 100 kHz 1 MHz 5 MHz 7 MHz
<i>Typical</i>	Noise sideband	Offset
Frequency = 1000 MHz	-102 dBc/Hz -108 dBc/Hz -108 dBc/Hz -108 dBc/Hz -115 dBc/Hz -133 dBc/Hz -135 dBc/Hz -136 dBc/Hz	1 kHz 10 kHz 20 kHz 30 kHz 100 kHz 1 MHz 5 MHz 7 MHz

**Table A-3: Noise sideband (Cont.)**

Characteristics	Description	
Frequency = 2000 MHz	-98 dBc/Hz -107 dBc/Hz -108 dBc/Hz -108 dBc/Hz -115 dBc/Hz -133 dBc/Hz -135 dBc/Hz -135 dBc/Hz	1 kHz 10 kHz 20 kHz 30 kHz 100 kHz 1 MHz 5 MHz 7 MHz
Frequency = 6000 MHz (RSA2208A only)	-90 dBc/Hz -106 dBc/Hz -106 dBc/Hz -108 dBc/Hz -114 dBc/Hz -131 dBc/Hz -132 dBc/Hz -133 dBc/Hz	1 kHz 10 kHz 20 kHz 30 kHz 100 kHz 1 MHz 5 MHz 7 MHz

**Table A-4: Input**

Characteristics	Description
Signal input	
Input connector	N type
Input impedance	50 $\Omega$
VSWR	<1.4 (2.5 GHz, RF attenuation $\geq$ 10 dB) <1.8 (7.5 GHz, RF attenuation $\geq$ 10 dB, RSA2208A only)
<i>Typical</i>	<1.4 (300 kHz to 10 MHz, RF attenuation $\geq$ 10 dB) <1.3 (10 MHz to 3 GHz, RF attenuation $\geq$ 10 dB) <1.4 (3 GHz to 8 GHz, RF attenuation $\geq$ 10 dB, RSA2208A only)
Maximum input level	
Maximum DC voltage	RF/RF1 to 3: $\pm$ 0.2 V; Baseband: $\pm$ 5 V (Option 05)
Maximum input power	+30 dBm (RF attenuation $\geq$ 10 dB)
Input attenuator	
RF attenuator	0 to 50 dB in 10 dB steps

**Table A-5: Amplitude**

Characteristics	Description
Reference level	
Setting range	-51 to +30 dBm in 1 dB steps (RF/RF1) -50 to +30 dBm in 1 dB steps (RF2/RF3, RSA2208A only) -30 to +20 dBm in 2 dB steps (Baseband (Option 05))
Accuracy (-10 to -50 dBm)	±0.2 dB (at 50 MHz, 10 dB attenuation, 20 to 30 °C)
Frequency response (RF attenuation ≥ 10 dB)	
at 20 to 30 °C	±1.2 dB (RF/RF1) ±1.7 dB (RF2, RSA2208A only) ±1.7 dB (RF3, RSA2208A only) ±0.5 dB (Baseband, 1 to 20 MHz (Option 05))
<i>Typical</i>	±0.3 dB (100 kHz to 20 MHz) ±0.5 dB (10 MHz to 3 GHz) ±0.5 dB (10 MHz to 3.5 GHz, RSA2208A only) ±1.0 dB (3.5 GHz to 6.5 GHz, RSA2208A only) ±1.0 dB (5 GHz to 8 GHz, RSA2208A only)
at 10 to 40 °C	±1.5 dB (RF/RF1) ±2.0 dB (RF2, RSA2208A only) ±2.0 dB (RF3, RSA2208A only) ±0.7 dB (Baseband, 1 to 20 MHz (Option 05))
Absolute amplitude accuracy at calibration point (0 dB attenuation, 20 to 30 °C)	±0.5 dB (at 50 MHz, -20 dBm signal) ±0.3 dB (at 10 MHz in baseband (Option 05), -10 dBm signal)
Input attenuator setting uncertainty	±0.5 dB (at 50 MHz)
Level linearity in display range	±0.2 dB (0 to -40 dBfs) ±0.2 dB (0 to -50 dBfs) ±0.12 dB (0 to -50 dBfs, <i>Typical</i> )

**Table A-6: Dynamic range**

Characteristics	Description
1 dB compression input	0 dBm (RF attenuation = 0 dB, 2 GHz)
Second harmonic distortion (-30 dBm tone at input mixer)	-56 dBc (10 MHz to 1500 MHz) -56 dBc (10 MHz to 1750 MHz, RSA2208A only)
3rd order intermodulation distortion (Reference level = +5 dBm, RF attenuation = Adjusted, Total signal power = -7 dBm)	
Center frequency = 2 GHz	-73 dBc
At 100 MHz to 3 GHz	-73 dBc
At 3 GHz to 8 GHz (RSA2208A only)	-72 dBc

**Table A-6: Dynamic range (Cont.)**

Characteristics	Description
Displayed average noise level	-144 dBm/Hz (100 Hz to 10 kHz, Option 05 only) -150 dBm/Hz (10 kHz to 10 MHz, Option 05 only) -148 dBm/Hz (10 MHz to 100 MHz) -148 dBm/Hz (100 MHz to 1 GHz) -148 dBm/Hz (1 GHz to 2 GHz) -147 dBm/Hz (2 GHz to 3 GHz) -142 dBm/Hz (3 GHz to 5 GHz, RSA2208A only) -142 dBm/Hz (5 GHz to 8 GHz, RSA2208A only)
ACLR (W-CDMA downlink, test model 1, 16 ch)	58 dB (5 MHz offset)
Local feed-through to input connector (Typical)	-40 dBm (local frequency 4.2 to 5 GHz) -55 dBm (local frequency 5 to 6 GHz) -60 dBm (local frequency 6 to 7 GHz) -60 dBm (local frequency 7 to 7.7 GHz, RSA2208A only)

**Table A-7: Spurious response**

Characteristics	Description
Image Suppression (Typical)	
1 <sup>st</sup> IF	75 dB (RF/RF1) 70 dB (RF2/RF3, RSA2208A only)
2 <sup>nd</sup> and 3 <sup>rd</sup> IF	80 dB (RF/RF1) 75 dB (RF2/RF3, RSA2208A only)
Residual response (Reference level = -30 dBm, RBW = 100 kHz)	
RF, 0.5 to 3 GHz (RSA2203A)	-90 dBm (Span = 2.5 GHz)
RF1, 0.5 to 3.5 GHz (RSA2208A)	-90 dBm (Span = 3 GHz)
RF2, 3.5 to 6.5 GHz (RSA2208A)	-85 dBm (Span = 3 GHz)
RF3, 5 to 8 GHz (RSA2208A)	-85 dBm (Span = 3 GHz)
Baseband (Option 05), 1 to 20 MHz	-93 dBm (Span = 20 MHz)
Spurious response with signal (Span = 10 MHz, Reference level = 0 dBm, RBW = 50 kHz)	
RF/RF1, 2 GHz	-70 dBc (Signal frequency = 2 GHz, Signal level = -5 dBm)
RF2, 5 GHz (RSA2208A)	-70 dBc (Signal frequency = 5 GHz, Signal level = -5 dBm)
RF3, 7 GHz (RSA2208A)	-70 dBc (Signal frequency = 7 GHz, Signal level = -5 dBm)
Baseband (Option 05), 10 MHz	-70 dBc (Signal frequency = 10 MHz, Signal level = -5 dBm)



**Table A-8: Acquisition**

Characteristics	Description
Acquisition mode	Single and Continuous
Acquisition memory size	2 Mbytes
Number of data samples in one frame	1024 (Vector mode)
Block size	1 to 500 frames
A/D converter	14 bits, 51.2 Msps
Vector span	10 MHz
Real-time capture bandwidth	RF: 10 MHz; Baseband: 20 MHz (Option 05 only)

**Table A-9: Sampling rate**

Characteristics	Description
Sampling rate (Real Time S/A, Demod, and Time modes)	
10 MHz span	12.8 Msps
5 MHz span	6.4 Msps
2 MHz span	3.2 Msps
1 MHz span	1.6 Msps
500 kHz span	800 ksps
200 kHz span	320 ksps
100 kHz span	160 ksps
50 kHz span	80 ksps
20 kHz span	32 ksps
10 kHz span	16 ksps
5 kHz span	8 ksps
2 kHz span	3.2 ksps
1 kHz span	1.6 ksps
500 Hz span	800 sps
200 Hz span	320 sps
100 Hz span	160 sps

**Table A-10: Frame time**

Characteristics	Description
Frame time (Real Time S/A, Demod, and Time modes)	
20 MHz span (Baseband only)	40 $\mu$ s
10 MHz span	80 $\mu$ s
5 MHz span	160 $\mu$ s
2 MHz span	320 $\mu$ s
1 MHz span	640 $\mu$ s
500 kHz span	1.28 ms
200 kHz span	3.2 ms
100 kHz span	6.4 ms
50 kHz span	12.8 ms
20 kHz span	32 ms
10 kHz span	64 ms
5 kHz span	128 ms
2 kHz span	320 ms
1 kHz span	640 ms
500 Hz span	1.28 s
200 Hz span	3.2 s
100 Hz span	6.4 s

**Table A-11: RBW (Resolution Bandwidth)**

Characteristics	Description
Filter shape	Gaussian, Rectangle, Root Nyquist
Setting range	1 Hz to 10 MHz
Minimum Resolution Bandwidth (S/A mode)	
>2 GHz span	100 kHz
1 to 1.99 GHz span	50 kHz
500 to 990 MHz span	20 kHz
200 to 490 MHz span	10 kHz
100 to 190 MHz span	10 kHz
50 to 90 MHz span	10 kHz
20 to 40 MHz span	10 kHz
10 MHz span	1 kHz
5 MHz span	1 kHz
2 MHz span	1 kHz
1 MHz span	1 kHz
500 kHz span	500 Hz
200 kHz span	200 Hz
100 kHz span	100 Hz
50 kHz span	50 Hz
20 kHz span	20 Hz
10 kHz span	10 Hz
5 kHz span	5 Hz
2 kHz span	2 Hz
1 kHz span	1 Hz
500 Hz span	1 Hz
200 Hz span	1 Hz
100 Hz span	1 Hz

**Table A-12: Analog demodulation**

Characteristics	Description
Accuracy ( <i>Typical</i> )	
AM demodulation	$\pm 2\%$ (-10 dBfs input at center, 10 to 60% modulation depth)
PM demodulation	$\pm 3^\circ$ (-10 dBfs input at center)
FM demodulation	$\pm 1\%$ of span (-10 dBfs input at center)

**Table A-13: Trigger**

Characteristics	Description
Trigger mode	Free run (Triggered by acquisition), Triggered (Triggered by event)
Trigger event source	IF (Level comparator), External (TTL)
Internal trigger comparator data source	A/D converter output
Pre/Post trigger setting	Trigger position settable from 0 to 100% of total data length.
IF level trigger setting range	1 to 100% (100% is full-scale of A/D converter output)
External trigger input	
Input voltage	High: +1.6 to +5 V; Low: 0 to +0.5 V
Input impedance	>2 k $\Omega$
Trigger output voltage	High: >2.0 V, Low: <0.4 V (output current <1 mA)
Trigger marker position timing uncertainty	$\pm 2$ sample points

**Table A-14: Measurement function**

Characteristics	Description
S/A mode	Noise power, Channel power, Adjacent channel power ratio, Occupied bandwidth, Emission bandwidth, Carrier to Noise ratio, Carrier frequency, Spurious
Demod mode	Analog demodulation (AM, FM, PM), I/Q vs. Time, Power vs. Time
Time mode	I/Q vs. Time, Power vs. Time, Frequency vs. Time, CCDF, Pulse measurement
Pulse measurement	Pulse width, Pulse peak power, On/Off ratio, Pulse ripple, Pulse repetition interval, Duty cycle, Pulse-Pulse phase, Channel power, OBW, EBW, Frequency deviation
Pulse length	Minimum 20 samples; Maximum 260,000 samples

**Table A-15: Display**

Characteristics	Description
View	
Number of views	1, 2, 3, or 4
Number of display traces	2
LCD	
Size	213 mm (8.4 in)
Resolution	800 $\times$ 600 pixels
Color	Maximum 256 colors

**Table A-16: Marker, trace, and display line**

Characteristics	Description
Marker type	Normal, Reference, and Band power
Search function	Peak right, Peak left, Maximum, Larger peak, and Smaller peak
Trace content	Active, Average, Max hold, Min hold, View, and Off
Display line	Horizontal line 1 and 2, Vertical line 1 and 2

**Table A-17: Controller and interface**

Characteristics	Description
Controller	
CPU	Intel Pentium III 850 MHz
DRAM	256 Mbyte DIMM
OS	Windows XP
System bus	PCI, ISA
Storage medium	
Hard disk	≥20 Gbyte 2.5 inch IDE
Floppy disk	1.44 Mbyte 3.5 inch
Interface	
Printer port	USB
GPIB	IEEE 488.1
LAN	10/100 BASE-T (IEEE 802.3)
Mouse	USB
Keyboard	USB
Monitor out	VGA (D-SUB 15 pins)

**Table A-18: Power requirements**

Characteristics	Description
Rating voltage	100 to 240 VAC
Voltage range	90 to 250 VAC
Line frequency	47 to 63 Hz
Mains Fuse Data	Densei-Lambda supplies: 5 A, Time-delayed, 250 V (not operator replaceable) Cosel supply: 2 A, Time-delayed, 250 V (not operator replaceable)
Heat dissipation	
Maximum power	350 VA
Maximum line current	5 A rms at 50 Hz (90 V line with 5% clipping)
Surge current	Maximum 52 A peak (25 °C) for ≤5 line cycles after the product has been turned off for at least 30 s.

**Table A-19: Power connector**

Characteristics	Description
Preamp power connector	
Connector type	LEMO 6 poles
Pin assignment	Pin 1: NC, Pin 2: ID1, Pin 3: ID2, Pin 4: -12 V, Pin 5: GND, Pin 6: +12 V

## Physical Characteristics

**Table A-20: Physical characteristics**

Characteristics	Description
Dimensions	
Width	425 mm (16.7 in) without belts
Height	215 mm (8.5 in) without feet
Depth	425 mm (16.7 in) without cover and feet
Net weight	19 kg

## Environmental Characteristics

**Table A-21: Environmental characteristics**

Characteristics	Description
Temperature	
Operating	+10 to +40 °C
Nonoperating	-20 to +60 °C
Relative humidity	
Operating and nonoperating	20 to 80% (no condensation), maximum wet-bulb temperature 29 °C
Altitude	
Operating	Up to 3000 m (10000 ft)
Nonoperating	Up to 12000 m (40000 ft)
Vibration	
Operating	2.65 m/s <sup>2</sup> rms (0.27 G rms), 5 to 500 Hz
Nonoperating	22.3 m/s <sup>2</sup> rms (2.28 G rms), 5 to 500 Hz
Shock	
Nonoperating	196 m/s <sup>2</sup> (20 G), half-sine, 11 ms duration Three shocks in each direction along each major axis, total of 18 shocks
Cooling clearance	
Bottom	20 mm (0.79 in)
Both sides	50 mm (1.97 in)
Rear	50 mm (1.97 in)

**Table A-22: Certifications and compliances**

Characteristic	Description																		
EC Declaration of Conformity – EMC	<p>Meets intent of Directive 89/336/EEC for Electromagnetic Compatibility. Compliance was demonstrated to the following specifications as listed in the Official Journal of the European Communities:</p> <table border="0"> <tr> <td>EN 61326</td> <td>EMC requirements for Class A electrical equipment for measurement, control and laboratory use. <sup>1</sup></td> </tr> <tr> <td>IEC 61000-4-2</td> <td>Electrostatic discharge immunity (Performance criterion B)</td> </tr> <tr> <td>IEC 61000-4-3</td> <td>RF electromagnetic field immunity (Performance criterion A)</td> </tr> <tr> <td>IEC 61000-4-4</td> <td>Electrical fast transient / burst immunity (Performance criterion B)</td> </tr> <tr> <td>IEC 61000-4-5</td> <td>Power line surge immunity (Performance criterion B)</td> </tr> <tr> <td>IEC 61000-4-6</td> <td>Conducted RF immunity (Performance criterion A)</td> </tr> <tr> <td>IEC 61000-4-11</td> <td>Voltage dips and interruptions immunity (Performance criterion B)</td> </tr> <tr> <td>EN 61000-3-2</td> <td>AC power line harmonic emissions</td> </tr> <tr> <td>EN 61000-3-3</td> <td>Power line voltage fluctuation/flicker</td> </tr> </table>	EN 61326	EMC requirements for Class A electrical equipment for measurement, control and laboratory use. <sup>1</sup>	IEC 61000-4-2	Electrostatic discharge immunity (Performance criterion B)	IEC 61000-4-3	RF electromagnetic field immunity (Performance criterion A)	IEC 61000-4-4	Electrical fast transient / burst immunity (Performance criterion B)	IEC 61000-4-5	Power line surge immunity (Performance criterion B)	IEC 61000-4-6	Conducted RF immunity (Performance criterion A)	IEC 61000-4-11	Voltage dips and interruptions immunity (Performance criterion B)	EN 61000-3-2	AC power line harmonic emissions	EN 61000-3-3	Power line voltage fluctuation/flicker
EN 61326	EMC requirements for Class A electrical equipment for measurement, control and laboratory use. <sup>1</sup>																		
IEC 61000-4-2	Electrostatic discharge immunity (Performance criterion B)																		
IEC 61000-4-3	RF electromagnetic field immunity (Performance criterion A)																		
IEC 61000-4-4	Electrical fast transient / burst immunity (Performance criterion B)																		
IEC 61000-4-5	Power line surge immunity (Performance criterion B)																		
IEC 61000-4-6	Conducted RF immunity (Performance criterion A)																		
IEC 61000-4-11	Voltage dips and interruptions immunity (Performance criterion B)																		
EN 61000-3-2	AC power line harmonic emissions																		
EN 61000-3-3	Power line voltage fluctuation/flicker																		
Australia/New Zealand Declaration of Conformity – EMC	<p>Complies with EMC provision of Radiocommunications Act per the following standard(s):</p> <table border="0"> <tr> <td>AS/NZS 2064.1/2</td> <td>Industrial, Scientific, and Medical Equipment: 1992</td> </tr> </table> <p>To ensure compliance with EMC requirements, only high quality shielded cables having a reliable, continuous outer shield (braid &amp; foil) with full coverage, low impedance connections to shielded connector housings at both ends should be connected to this product..</p>	AS/NZS 2064.1/2	Industrial, Scientific, and Medical Equipment: 1992																
AS/NZS 2064.1/2	Industrial, Scientific, and Medical Equipment: 1992																		
EC Declaration of Conformity – Low Voltage	<p>Compliance was demonstrated to the following specification as listed in the Official Journal of the European Union:</p> <p>Low Voltage Directive 73/23/EEC, amended by 93/68/EEC</p> <table border="0"> <tr> <td>EN 61010-1:2001</td> <td>Safety requirements for electrical equipment for measurement control and laboratory use.</td> </tr> </table>	EN 61010-1:2001	Safety requirements for electrical equipment for measurement control and laboratory use.																
EN 61010-1:2001	Safety requirements for electrical equipment for measurement control and laboratory use.																		
U.S. Nationally Recognized Testing Laboratory Listing	<table border="0"> <tr> <td>UL61010B-1</td> <td>Standard for electrical measuring and test equipment.</td> </tr> </table>	UL61010B-1	Standard for electrical measuring and test equipment.																
UL61010B-1	Standard for electrical measuring and test equipment.																		
Canadian Certification	<table border="0"> <tr> <td>CAN/CSA C22.2 No. 1010.1</td> <td>CSA safety requirements for electrical and electronic measuring and test equipment.</td> </tr> </table>	CAN/CSA C22.2 No. 1010.1	CSA safety requirements for electrical and electronic measuring and test equipment.																
CAN/CSA C22.2 No. 1010.1	CSA safety requirements for electrical and electronic measuring and test equipment.																		
Additional Compliance	<table border="0"> <tr> <td>ANSI/ISA S82.02.01:1999</td> <td>Safety standard for electrical and electronic test, measuring, controlling, and related equipment.</td> </tr> <tr> <td>IEC61010-1</td> <td>Safety requirements for electrical equipment for measurement, control, and laboratory use.</td> </tr> </table>	ANSI/ISA S82.02.01:1999	Safety standard for electrical and electronic test, measuring, controlling, and related equipment.	IEC61010-1	Safety requirements for electrical equipment for measurement, control, and laboratory use.														
ANSI/ISA S82.02.01:1999	Safety standard for electrical and electronic test, measuring, controlling, and related equipment.																		
IEC61010-1	Safety requirements for electrical equipment for measurement, control, and laboratory use.																		

<sup>1</sup> Emissions which exceed the levels required by this standard may occur when this equipment is connected to a test object.



**Table A-22: Certifications and compliances (Cont.)**

<b>Characteristic</b>	<b>Description</b>
Installation (Overvoltage) Category	<p>Terminals on this product may have different installation (overvoltage) category designations. The installation categories are:</p> <p>CAT III Distribution-level mains (usually permanently connected). Equipment at this level is typically in a fixed industrial location.</p> <p>CAT II Local-level mains (wall sockets). Equipment at this level includes appliances, portable tools, and similar products. Equipment is usually cord-connected.</p> <p>CAT I Secondary (signal level) or battery operated circuits of electronic equipment.</p>
Pollution Degree Descriptions	<p>A measure of the contaminants that could occur in the environment around and within a product. Typically the internal environment inside a product is considered to be the same as the external. Products should be used only in the environment for which they are rated.</p> <p>Pollution Degree 1 No pollution or only dry, nonconductive pollution occurs. Products in this category are generally encapsulated, hermetically sealed, or located in clean rooms.</p> <p>Pollution Degree 2 Normally only dry, nonconductive pollution occurs. Occasionally a temporary conductivity that is caused by condensation must be expected. This location is a typical office/home environment. Temporary condensation occurs only when the product is out of service.</p> <p>Pollution Degree 3 Conductive pollution, or dry, nonconductive pollution that becomes conductive due to condensation. These are sheltered locations where neither temperature nor humidity is controlled. The area is protected from direct sunshine, rain, or direct wind.</p> <p>Pollution Degree 4 Pollution that generates persistent conductivity through conductive dust, rain, or snow. Typical outdoor locations.</p>
Safety Certification Compliance	
Equipment Type	Test and measuring
Safety Class	Class 1 (as defined in IEC61010-1, Annex H) – grounded product
Operating Temperature Range	+5 to +40 °C
Overvoltage Category	Overvoltage Category II (as defined in IEC61010-1, Annex J)
Pollution Degree	Pollution Degree 2 (as defined in IEC61010-1). Note: Rated for indoor use only.



# Appendix B: Menu Tree

This section shows the structure of the menus and submenus displayed by pressing the menu keys as illustrated in Figure B-1. The menu keys are divided into the following groups:

- MEASUREMENT
- DISPLAY
  - MODE
  - MARKERS
  - VIEW
- UTILITY

Some of the submenus are used for programming or servicing; information about these submenus is in the *RSA2203A and RSA2208A Programmer Manual* or *Service Manual* (optional).

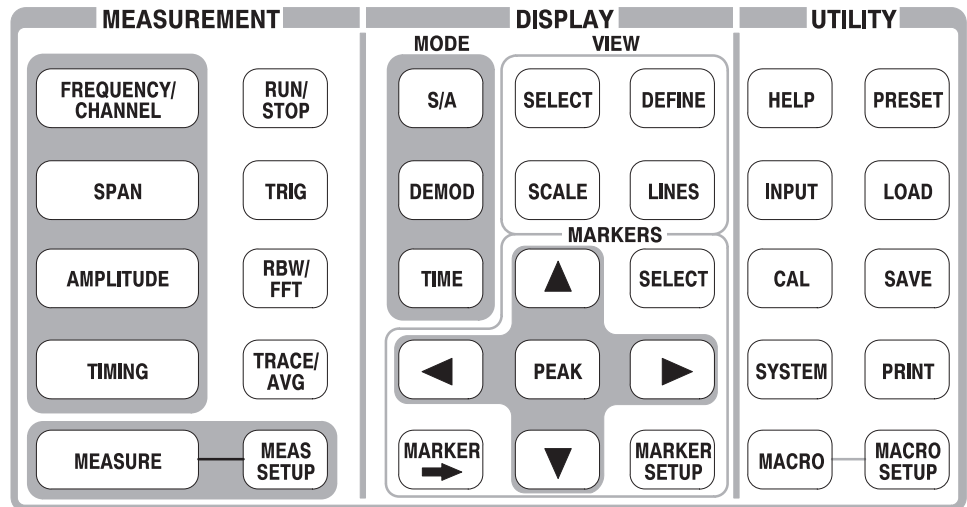
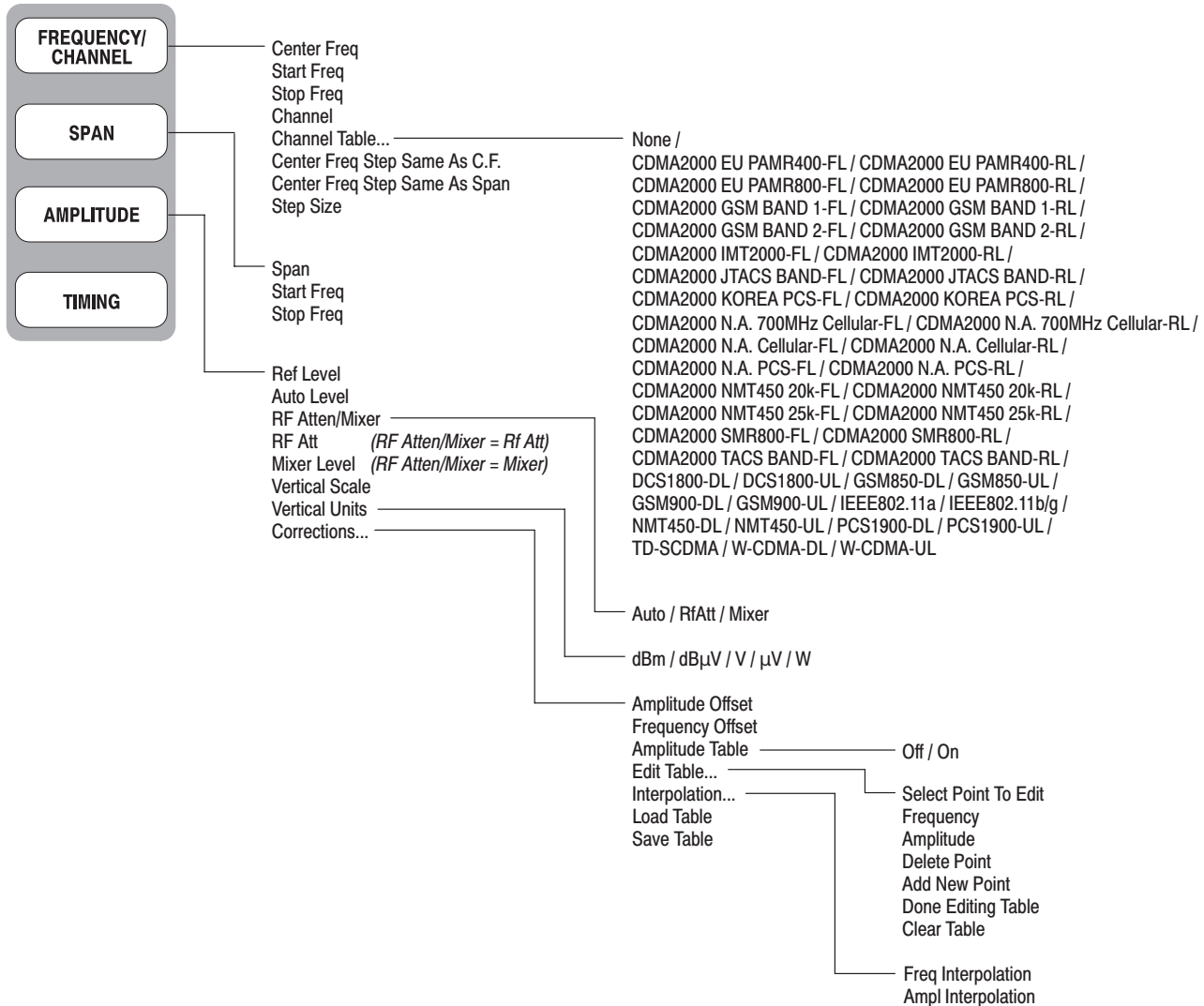
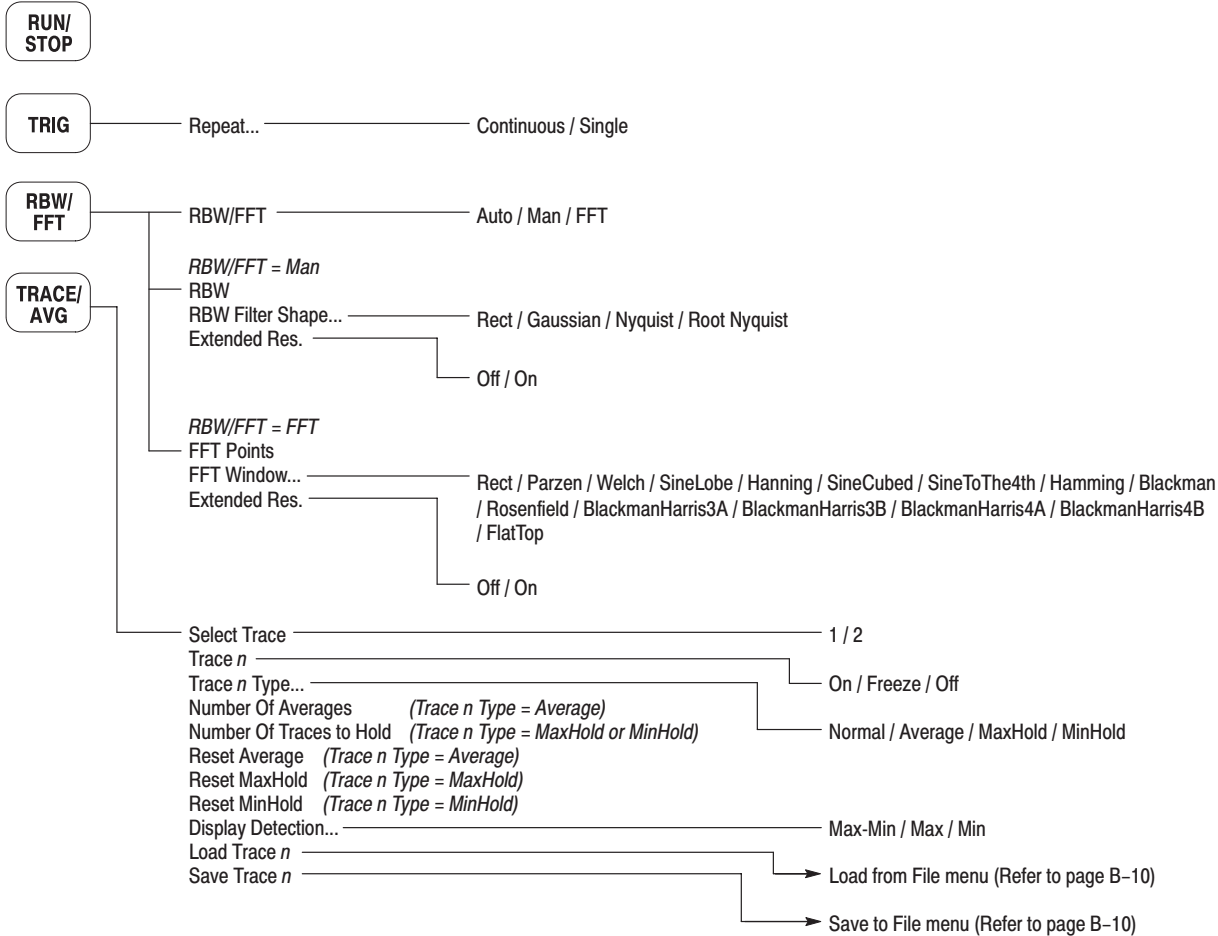


Figure B-1: Menu keys

## Measurement Menu (1 of 3)

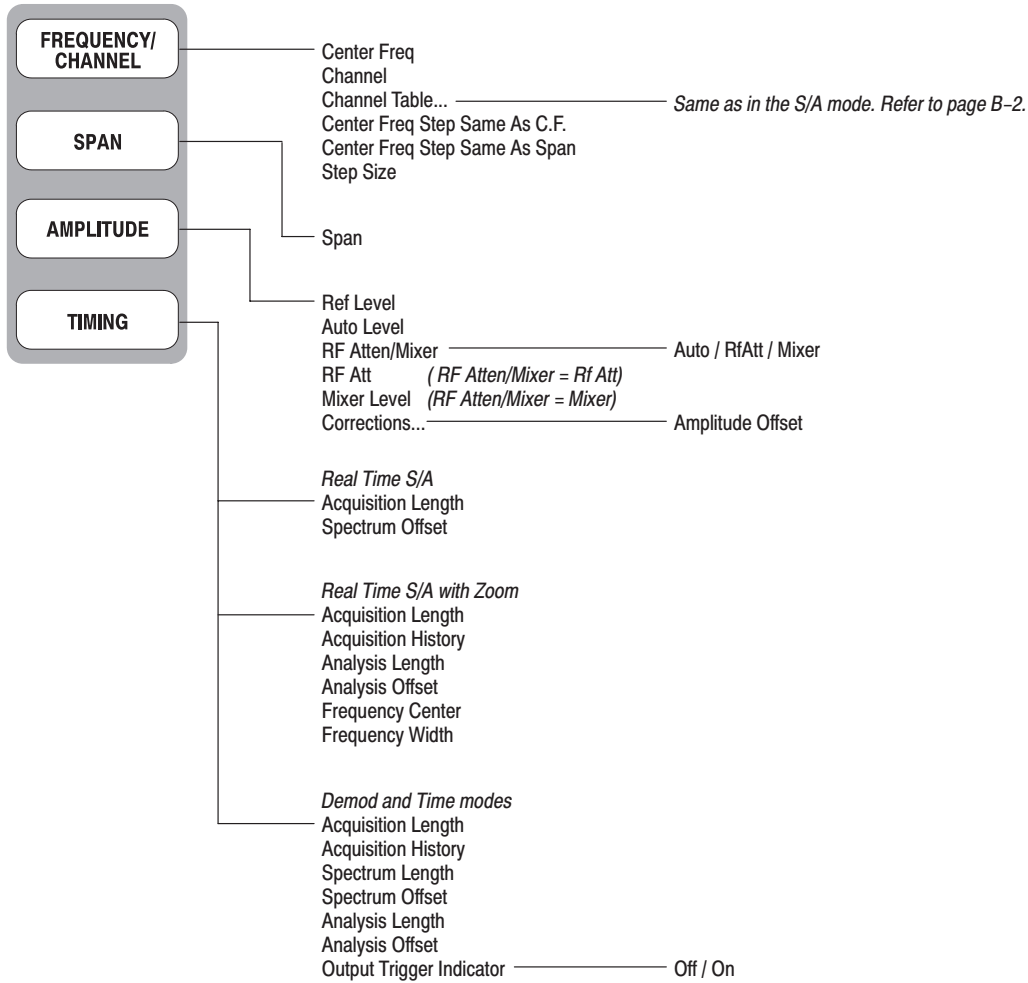
### S/A Mode except Real Time S/A

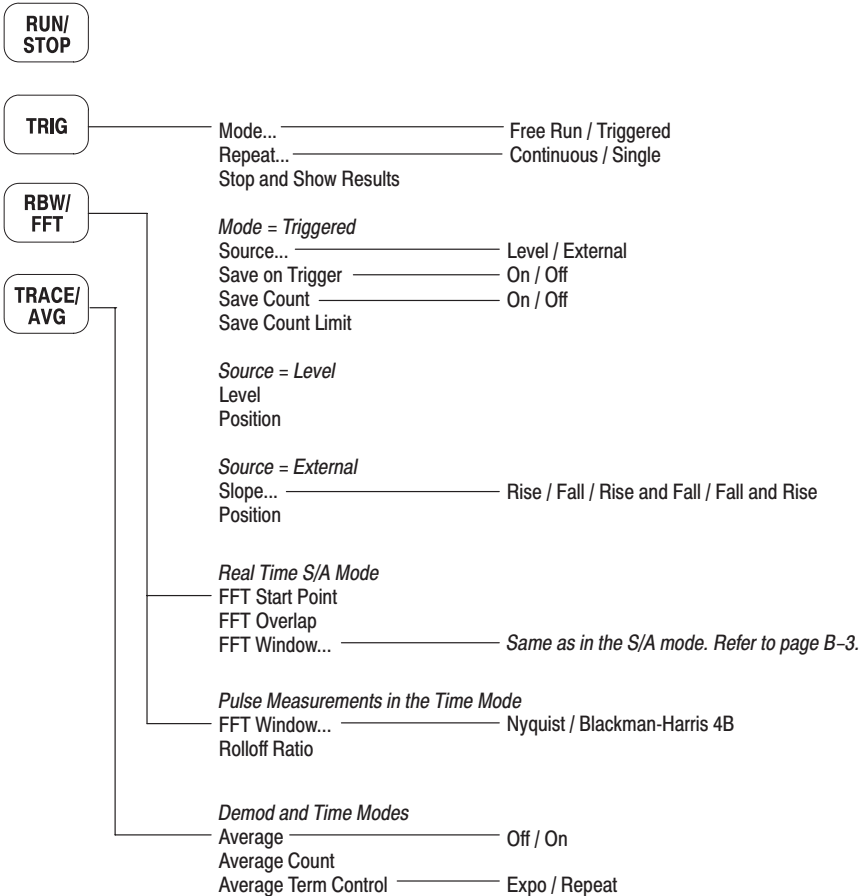




## Measurement Menu (2 of 3)

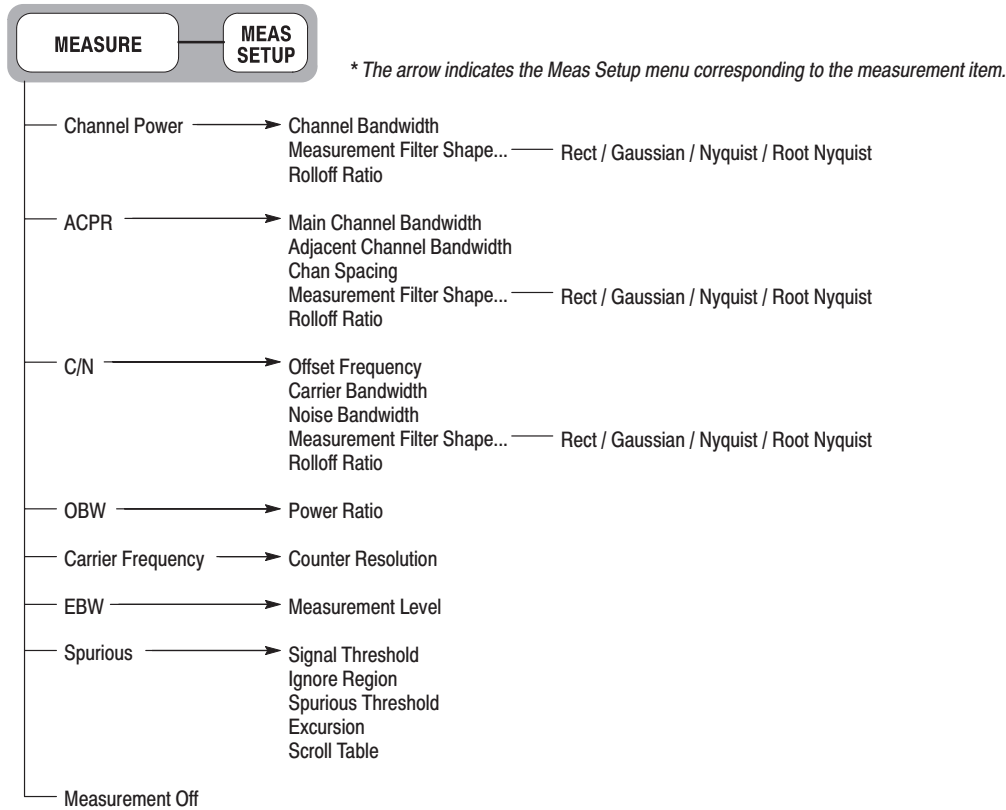
### Real Time S/A, Demod and Time Modes



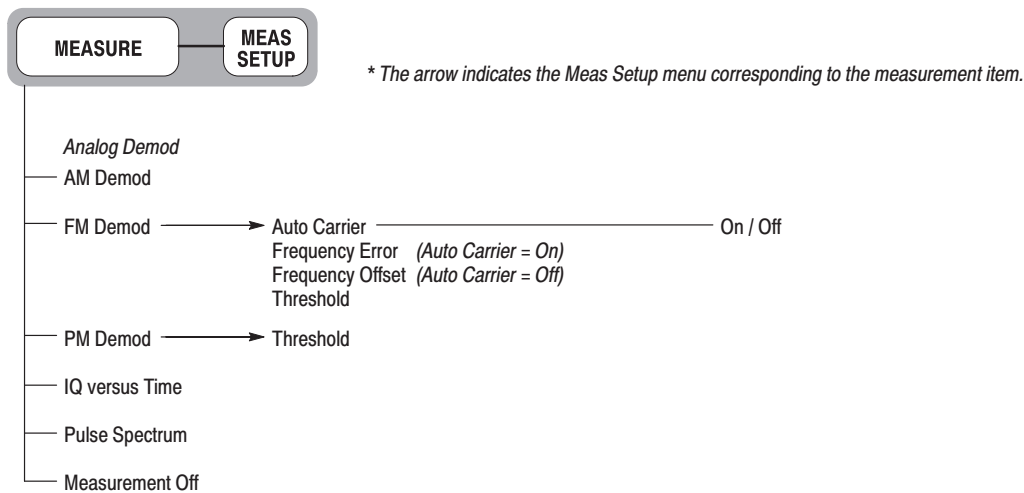


## Measurement Menu (3 of 3)

### S/A Mode

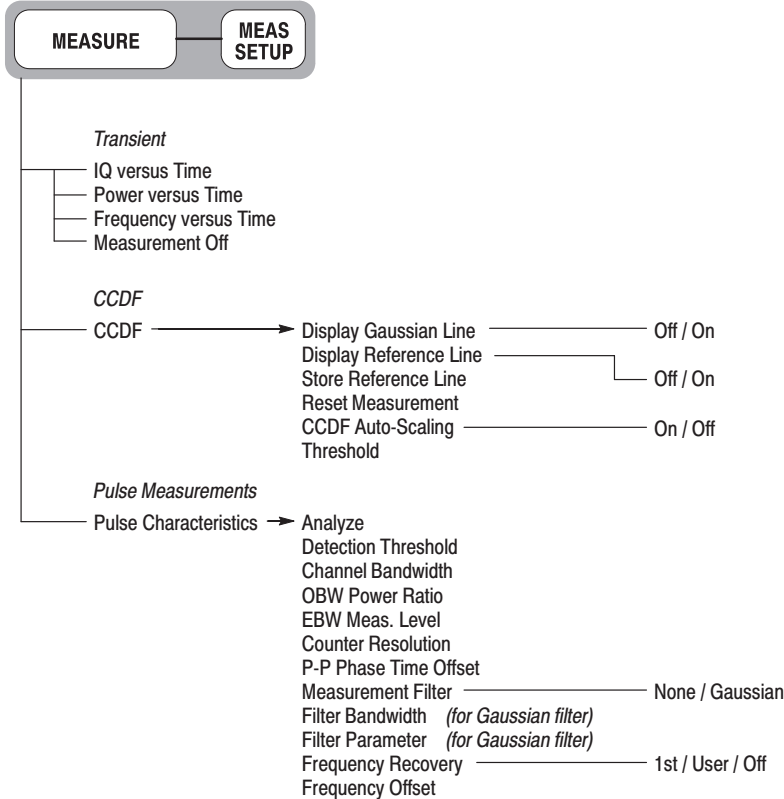


### Demod Mode

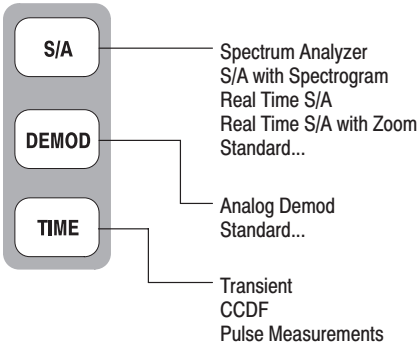




**Time Mode**

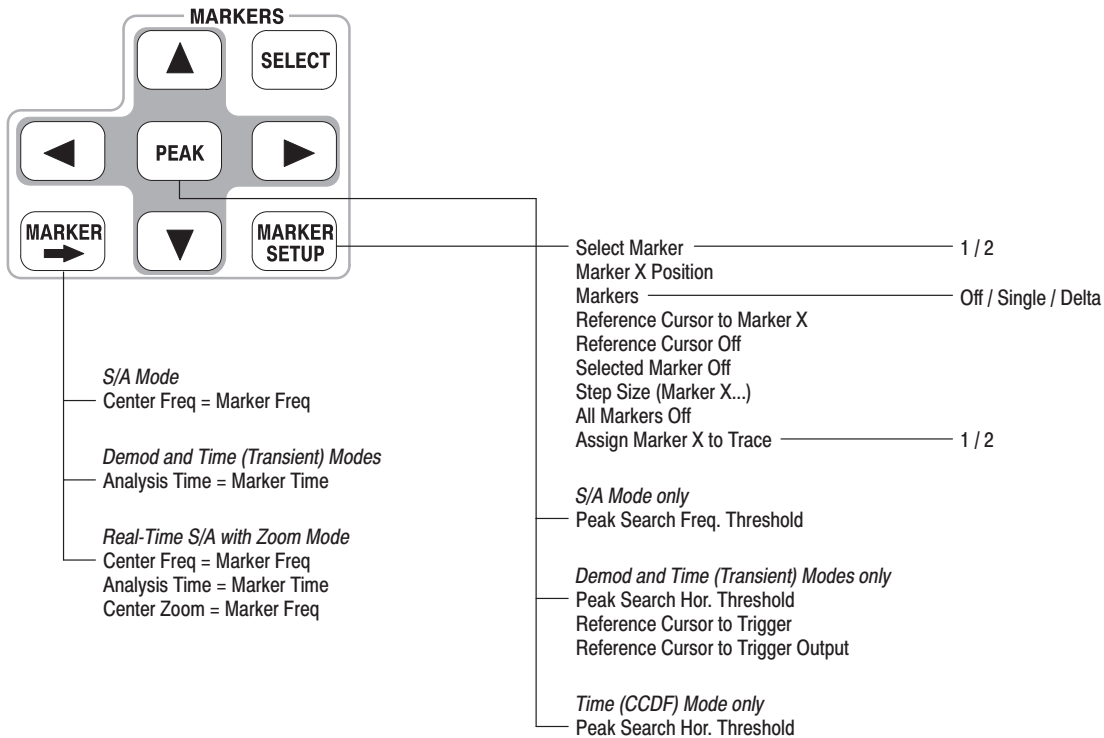


**Display: Mode Menu**

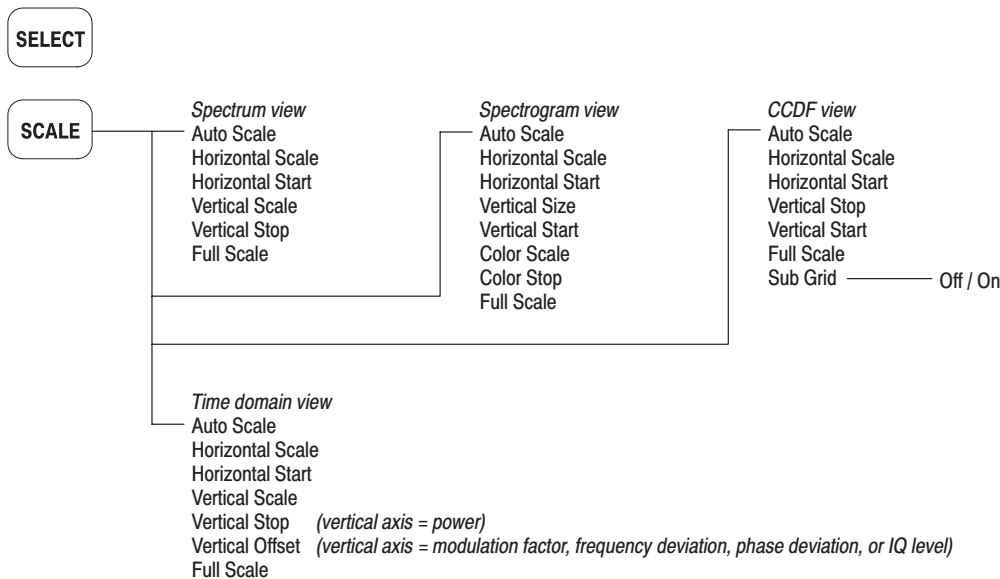


\* For details about the Standard... menu, refer to the optional software user manual.

## Display: Markers Menu

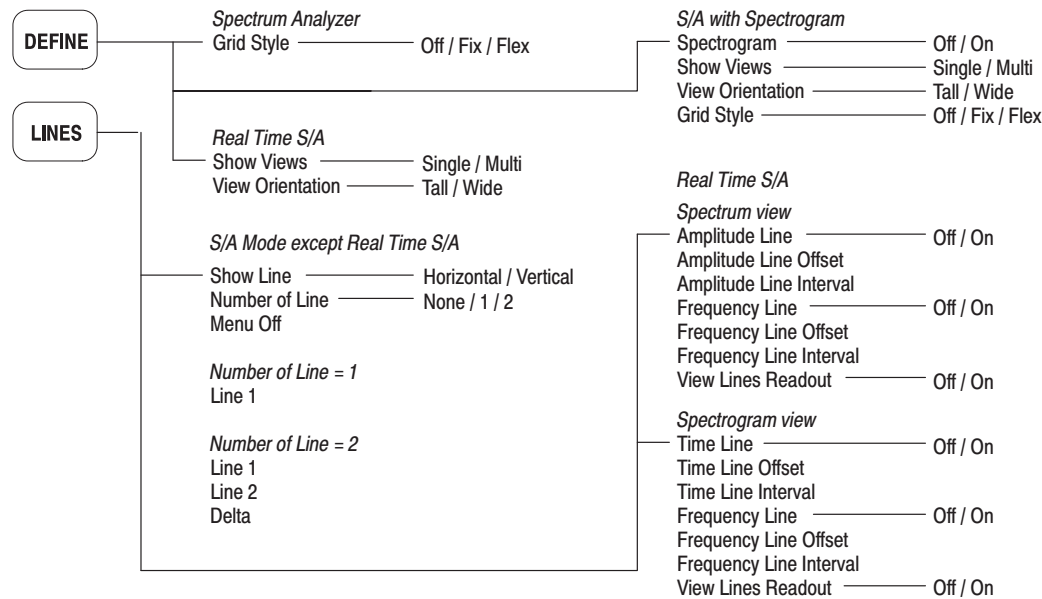


## Display: View Menu (1 of 2)

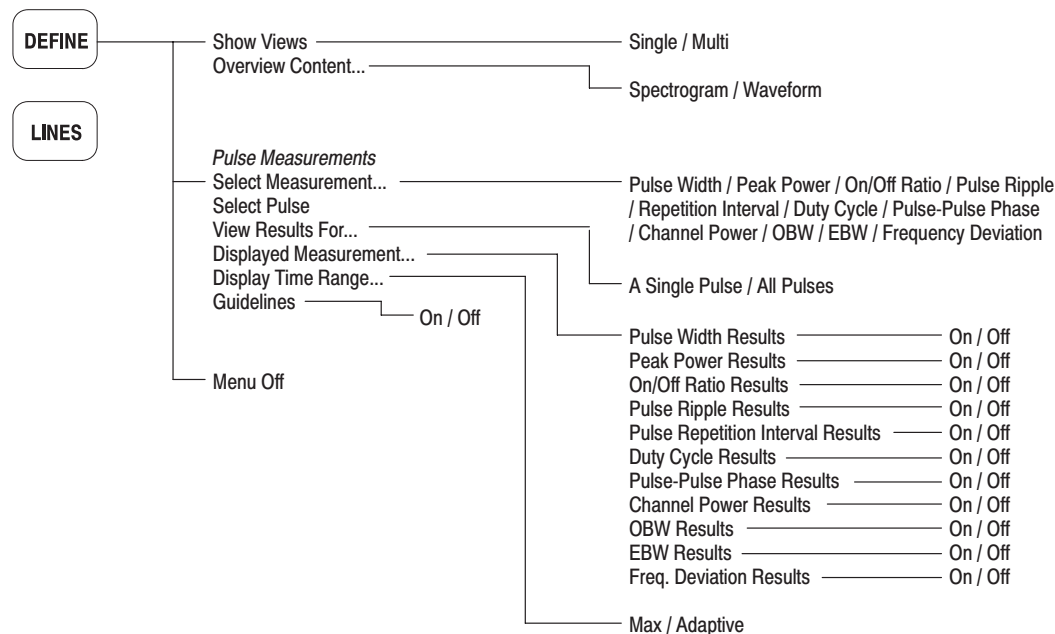


## Display: View Menu (2 of 2)

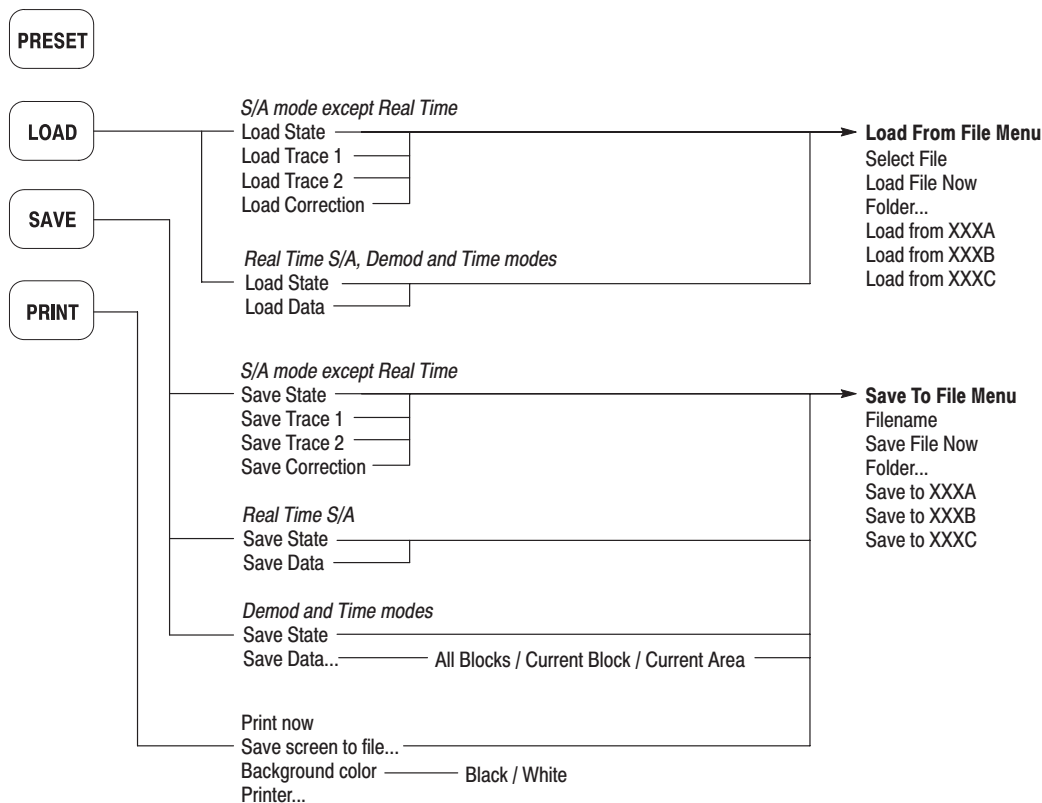
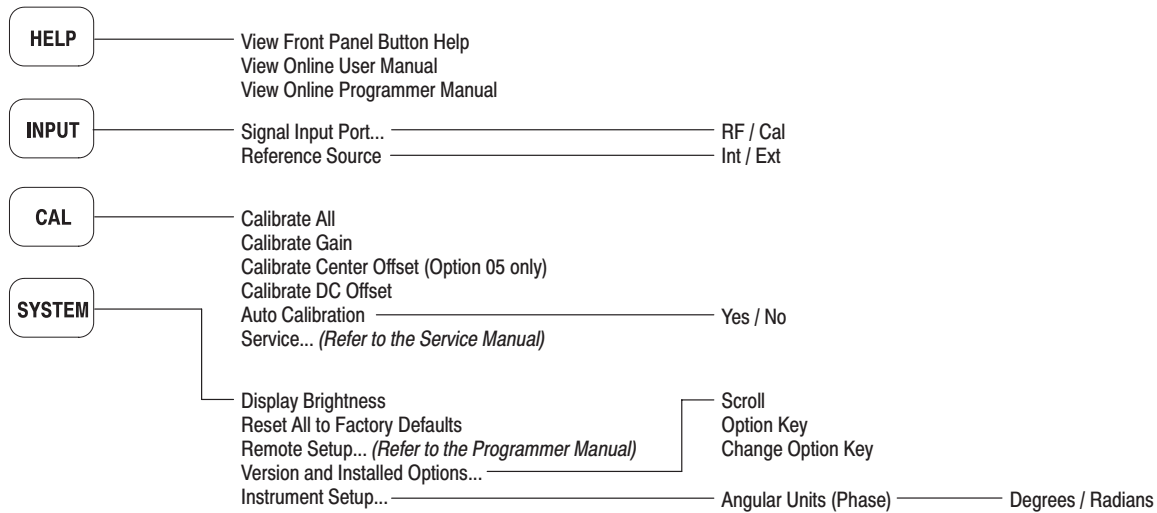
### S/A Mode



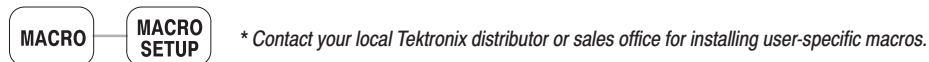
### Demod and Time Modes



## Utility Menu



Where XXX =  
 State for a state file  
 IQData for an IQ data file  
 Trace for a trace file  
 Corr for a correction file  
 Bitmap for a bitmap file



## Appendix C: Default Settings

The tables in this section list the default values for parameters set in the menus.

Pressing the **PRESET** key returns the analyzer to the default state for the measurement mode in use (S/A, Demod, or Time). Values for checked items (✓) in these tables are common to all measurement modes.

**Table C-1: Measurement menu**

Menu	S/A mode	Demod/Time mode	Common
<b>FREQUENCY/CHANNEL</b>			
Center Freq	1.5 GHz	1.5 GHz	✓
Start Freq	1.495 GHz	-	✓
Stop Freq	1.505 GHz	-	✓
Channel Table...	None	None	
Step Size (Center Freq)	100 kHz	100 kHz	
<b>SPAN</b>			
Span	10 MHz	10 MHz	✓
Start Freq	1.495 GHz	-	✓
Stop Freq	1.505 GHz	-	✓
<b>AMPLITUDE</b>			
Ref Level	0 dBm	0 dBm	✓
RF Atten / Mixer	Auto	Auto	✓
Mixer Level	-25 dBm	-25 dBm	✓
Vertical Scale	10 dB/div	-	
Vertical Units	dBm	-	
Corrections...		-	
Amplitude Offset	0 dB	-	
Frequency Offset	0 Hz	-	
Amplitude Table	Off	-	
Corrections...→ Interpolation			
Freq Interpolation	Lin	-	
Ampl Interpolation	dB	-	

**Table C-1: Measurement menu (Cont.)**

<b>Menu</b>	<b>S/A mode</b>	<b>Demod/Time mode</b>	<b>Common</b>
<b>TIMING</b>			
Acquisition Length	-	160 $\mu$ s	
Acquisition History	-	0	
Spectrum Length	-	80 $\mu$ s	
Spectrum Offset	-	0	
Analysis Length	-	160 $\mu$ s	
Analysis Offset	-	0	
<b>TRIG</b>			
Mode...	-	Free Run	
Repeat...	Continuous	Continuous	
<b>RBW/FFT</b>			
RBW/FFT	Auto	-	
<b>TRACE/AVG</b>			
Select Trace	1	-	
Trace 1	On	-	
Trace 1 Type...	Normal	-	
Number Of Averages	20	-	
Display Detection...	Max	-	
Average	-	Off	
Average Count	-	20	
Average Term Control	-	Expo	
<b>MEASURE</b>	Measurement Off	Measurement Off	

**Table C-2: Display menu**

Menu	S/A mode	Demod/Time mode	Common
<b>DEFINE</b>			
Grid Style	Fix	-	
Show Views	-	Multi	
Overview Content...	-	Waveform	
<b>SCALE</b>			
Horizontal Scale	10 MHz	320 $\mu$ s	
Horizontal Start	1.495 GHz	-320 $\mu$ s	
Vertical Scale	100 dB	100 dB	
Vertical Stop	0 dBm	0 dBm	
<b>LINES</b>			
Show Line	Horizontal	-	
Number Of Line	None	-	
<b>MARKER SETUP</b>			
Marker X Position	0	0	
Markers	Off	Off	
Step Size (Marker X Position)	10 kHz	160 ns	
Peak Search Freq Threshold	200 kHz	-	
Peak Search Hor. Threshold	-	3.2 $\mu$ s	

**Table C-3: Utility menu**

Menu	S/A mode	Demod/Time mode	Common
<b>INPUT</b>			
Signal Input Port...	RF	RF	✓
Reference Source	Int	Int	✓



# Appendix D: Inspection and Cleaning

Inspect and clean the exterior of the instrument as often as operating conditions require. Dirt acts as an insulating blanket, preventing efficient heat dissipation. Regular cleaning may prevent instrument malfunction and enhance reliability.



**WARNING.** To avoid personal injury, unplug the power cord from line voltage before cleaning the instrument. To avoid getting moisture inside the instrument during external cleaning, use only enough liquid to dampen the applicator.

## Inspecting the Exterior

Inspect the outside of the instrument for damage, wear, and missing parts, using Table D-1 as a guide. Instruments that appear to have been dropped or otherwise abused should be checked thoroughly to verify correct operation and performance. Immediately repair defects that could cause personal injury or lead to further damage to the instrument.

**Table D-1: External inspection check list**

Item	Inspect for	Repair action
Cabinet, front panel, and cover	Cracks, scratches, deformations, damaged hardware or gaskets.	Contact your local Tektronix distributor or sales office.
Front-panel knobs	Missing, damaged, or loose knobs.	
Connectors	Broken shells, cracked insulation, and deformed contacts. Dirt in connectors.	
Carrying handle	Correct operation.	
Accessories	Missing items or parts of items, bent pins, broken or frayed cables, and damaged connectors.	



---

**CAUTION.** *Avoid the use of chemical cleaning agents that might damage the plastics used in this instrument. Organic solvents such as benzene and acetone must never be used.*

---

## Cleaning the Exterior

Remove the power cord before cleaning the instrument. Clean the exterior surfaces of the instrument with a dry, lint-free cloth or a soft-bristle brush. If dirt remains, use a cloth or swab dampened with a 75% isopropyl alcohol solution. A swab is useful for cleaning in narrow spaces around the controls and connectors. Do not use abrasive compounds on any part of the instrument.



---

**CAUTION.** *Do not allow moisture inside the instrument. During exterior cleaning, use only enough solution to dampen the cloth or swab.*

---

## Lubrication

There is no periodic lubrication required for this instrument.

## Cleaning the Interior

Consult your Tektronix Service Center or representative for cleaning the analyzer interior.

# Appendix E: Options and Accessories

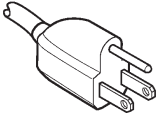
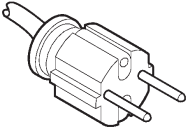
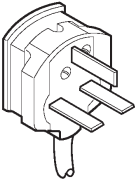
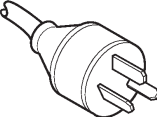
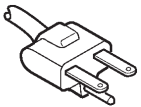
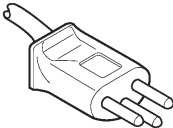
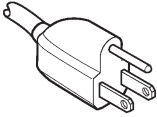
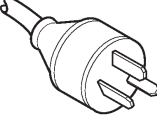
This appendix describes the options and standard and optional accessories that are available for the analyzer.

## Options

The following options can be ordered for the analyzer:

- Option 1R: Rack Mount Kit (includes: hardware and instructions for converting to 19-inch rackmount configuration)
- Option 2A: External preamplifier (20 dB gain to 3 GHz)
- Option 05: DC-20 MHz baseband frequency extension
- Option 10: OCXO high stability reference oscillator,  $1 \times 10^{-9}$
- Option 12: USB keyboard and mouse
- Option C3: Calibration service, 3 years
- Option C5: Calibration service, 5 years
- Option D1: Calibration data report
- Option D3: Calibration data report, 3 years (requires Option C3)
- Option D5: Calibration data report, 5 years (requires Option C5)
- Option L5: Provides Japanese language user manual and programmer manual instead of English manuals.
- Option R3: Repair service, 3 years
- Option R5: Repair service, 5 years
- Power cord options listed in Table E-1.

**Table E-1: Power cord identification**

Plug configuration	Normal usage	Option number
	North America 120 V	A0
	Universal Euro 230 V	A1
	United Kingdom 230 V	A2
	Australia 240 V	A3
	North America 240 V	A4
	Switzerland 220 V	A5
	Japan 100 V	A6
	China 240 V	A10
	No power cord supplied.	A99

## Standard Accessories

All analyzers in this series are shipped with the accessories listed in Table E-2.

**Table E-2: Standard accessories**

<b>Accessory</b>	<b>Part number</b>
English language user manual	071-1334-XX
English language programmer manual	071-1336-XX
U.S. power cord	161-0104-00
BNC-N adapter	103-0045-XX
Front cover	200-A524-XX

## Optional Accessories

You can order the accessories listed in Table E-3 to use with your analyzer.

**Table E-3: Optional accessories**

<b>Accessory</b>	<b>Part number</b>
Japanese language user manual	071-1333-XX
Japanese language programmer manual	071-1335-XX
USB mouse	119-B145-XX
USB keyboard	119-B146-XX
Service manual	071-1337-XX
Accessory bag	016-A330-XX
Preamplifier (20 dB gain to 3 GHz)	650-A900-XX
RTPA2A real-time probe adapter (P7000 series probes recommended)	
Rack mount kit (for field conversion)	



# Glossary





# Glossary

**Accuracy**

The closeness of the indicated value to the true value.

**Acquisition**

A series of time-contiguous frames. This is also called a Block.

**Acquisition Time**

The length of time contained in one acquisition.

**Amplitude**

The magnitude of an electrical signal.

**Amplitude Modulation (AM)**

The process, or result of a process, in which the amplitude of a sine wave (the carrier) is varied in accordance with the instantaneous voltage of a second electrical signal (the modulating signal).

**Analysis Time**

A subset of time-contiguous samples from one Block Time, used as input to an Analysis View.

**Analysis View**

Any view which produces measurement results except for Spectrum, Power versus Time, and Spectrogram.

**ASK**

Acronym for Amplitude Shift Keying. The process, or result of a process, in which the amplitude of the carrier is varied in accordance with the state of a digital input signal.

**Block**

See *Acquisition*.

**Calibrator**

A signal generator producing a specified output used for calibration purposes.

**Carrier, Carrier Signal**

The electrical signal, typically a sine wave, upon which modulation is impressed.

**Carrier Frequency**

The frequency of the carrier signal.

**Carrier-to-Noise Ratio (C/N)**

The ratio of carrier signal power to average noise power in a given bandwidth surrounding the carrier; usually expressed in decibels.

**Center Frequency**

That frequency which corresponds to the center of a frequency span, expressed in hertz.

**Clear (Erase)**

Presets memory to a prescribed state, usually that denoting zero.

**Controls**

User-accessible mechanisms to modify setup parameters.

**dBm**

A unit of expressed power level in decibels referenced to 1 milliwatt.

**dBmV**

A unit to express voltage levels in decibels referenced to 1 millivolt.

**dB $\mu$ V**

A unit to express voltage levels in decibels referenced to 1 microvolt.

**Decibel (dB)**

Ten times the logarithm of the ratio of one electrical power to another.

**Depth of Modulation**

The difference between the maximum and the minimum of the RF envelope amplitude expressed as a percentage of the maximum RF envelope level.

**Display Law**

The mathematical law that defines the input-output function of the instrument. The following cases apply:

**Linear**

A display in which the scale divisions are a linear function of the input signal voltage.

**Square Law (Power)**

A display in which the scale divisions are a linear function of the input signal power.

**Logarithmic**

A display in which the scale divisions are a logarithmic function of the input signal voltage.

**Display Line**

A horizontal or vertical line on a waveform display, used as a reference for visual (or automatic) comparison with a given level, time, or frequency.

**Display Reference Level**

A designated vertical position representing a specified input level. The level may be expressed in dBm, volts, or any other units.

**Distortion**

Degradation of a signal, often a result of nonlinear operations, resulting in unwanted signal components. Harmonic and intermodulation distortion are common types.

**Dynamic Range**

The maximum ratio of the levels of two signals simultaneously present at the input which can be measured to a specified accuracy.

**Export**

Save data to a file in a format other than application-native.

**FFT Time**

The length of time covered by one frame, whether or not an RBW filter is applied to the FFT. This was previously called a “multi-frame”.

**Filter**

A circuit which separates electrical signals or signal components based on their frequencies.

**Frame**

A series of time-contiguous samples, long enough in duration and at a sufficient sample rate to produce a spectrum view of a specified span and RBW.

**Frequency**

The rate at which a signal oscillates, or changes polarity, expressed as hertz or number of cycles per second.

**Frequency Band**

The continuous range of frequencies extending between two limiting frequencies, expressed in hertz.

**Frequency Domain Representation**

The portrayal of a signal in the frequency domain; representing a signal by displaying its sine wave components; the signal spectrum.

**Frequency Drift**

Gradual shift or change in displayed frequency over the specified time due to internal changes in the spectrum analyzer, where other conditions remain constant. Expressed in hertz per second.

**Frequency Modulation (FM)**

The process, or result of a process, in which the frequency of an electrical signal (the carrier) is varied in accordance with some characteristic of a second electrical signal (the modulating signal or modulation).

**Frequency Range**

The range of frequencies over which the performance of the instrument is specified.

**Frequency Span (Dispersion)**

The magnitude of the frequency band displayed; expressed in hertz or hertz per division.

**FSK**

Acronym for Frequency Shift Keying. The process, or result of a process, in which the frequency of the carrier is varied in accordance with the state of a digital input signal.

**GPIB**

Acronym for General Purpose Interface Bus, the common name for the communications interface system defined in IEEE Std 488.

**Graticule**

The calibrated grid overlaying the display screen of spectrum analyzers, oscilloscopes, and other test instruments.

**Grayed Out**

An on-screen control is “Grayed Out” if it is not adjustable.

**Import**

Bring data into the application from a file of some format other than application-native.

**Input Impedance**

The impedance at the desired input terminal. Usually expressed in terms of VSWR, return loss, or other related terms for low impedance devices and resistance-capacitance parameters for high impedance devices.

**Intermediate Frequency (IF)**

In a heterodyne process, the sum or difference frequency at the output of a mixer stage which will be used for further signal processing.

**Key Contacts**

A pattern of interlaced fingers on the front-panel circuit board that form a contact closure when mated with a conductive pad under a mechanical front panel button.

**Link**

Connect to a file containing settings or other data to be used by the application. Maintain the connection.

**Live Trace**

Any combination of the A trace and/or the B trace when SAVE A is off.

**Load**

Copy settings or other data from a file, but don't maintain any connection with that file.

**Local Oscillator (LO)**

An oscillator which produces the internal signal that is mixed with an incoming signal to produce the IF signal.

**Marker**

A visually identifiable point on a waveform trace, used to extract a readout of domain and range values represented by that point.

**MAX HOLD**

Digitally stored display mode which, at each frequency address, compares the incoming signal level to the stored level and retains the greater level. In this mode, the display indicates the peak level at each frequency after several successive sweeps.

**MIN HOLD**

A spectrum analyzer feature which captures the minimum signal amplitude at all displayed frequencies over a series of sweeps.

**Modulate**

To regulate or vary a characteristic of a signal.

**Modulating Signal**

The signal which modulates a carrier. The signal which varies or regulates some characteristic of another signal.

**Modulation**

The process of varying some characteristic of a signal with a second signal.

**Noise**

Unwanted random disturbances superimposed on a signal which tend to obscure it.

**Noise Floor**

The self-noise of an instrument or system that represents the minimum limit at which input signals can be observed. The spectrum analyzer noise floor appears as a "grassy" baseline in the display, even when no signal is present.

**Open (Recall, Restore)**

Bring data into the application from a file of application-native format.

**OQPSK**

Acronym for Offset QPSK (Quadrature Phase Shift Keying).

**PDF**

Acronym for Probability Distribution Function.

**Peak Detection**

A detection scheme wherein the peak amplitude of a signal is measured and displayed. In spectrum analysis, 20 log (peak) is often displayed.

**Platform Utility**

User-available software applications provided with the instrument.

**Primary Marker**

The marker displayed in the Single Marker mode whose frequency and/or position is changed when tuning with the general purpose knob.

**PSK**

Acronym for Phase Shift Keying. The process, or result of a process, in which the carrier phase is varied discretely in accordance with a digital code.

**QAM**

Acronym for Quadrature Amplitude Modulation. The process, or result of a process, in which the amplitude and phase of the carrier are varied concurrently by synthesizing two orthogonal ASK waves (see *ASK*).

**Reference Level**

The signal level required to deflect the CRT display to the top graticule line.

**Residual FM (Incidental FM)**

Short term displayed frequency instability or jitter due to instability in the spectrum analyzer local oscillators. Given in terms of peak-to-peak frequency deviation and expressed in hertz or percent of the displayed frequency.

**Residual Response**

A spurious response in the absence of an input signal. (Noise and zero pip are excluded.)

**Resolution Bandwidth (RBW)**

The width of the narrowest filter in the IF stages of a spectrum analyzer. The RBW determines how well the analyzer can resolve or separate two or more closely spaced signal components.

**Save**

Commit data to memory in application-native format.

**Secondary Marker**

The “second” marker displayed only in the Delta Marker mode.

**Sensitivity**

Measure of a spectrum analyzer’s ability to display minimum level signals, expressed in volts or decibels. Internal frequency (IF) bandwidth, display mode, and any other influencing factors must be given.

**Shape Factor (Skirt Selectivity)**

The ratio of the frequency separation of the two (60 dB/6 dB) down points on the response curve to the static resolution bandwidth.

**Single Sweep**

Operating mode in which the sweep generator must be reset for each sweep. Especially useful for obtaining single examples of a signal spectrum.

**Span Per Division, Span/Div**

Frequency difference represented by each major horizontal division of the graticule.

**Spectrum**

The frequency domain representation of a signal wherein it is represented by displaying its frequency distribution.

**Spectrum Analysis**

The technique or process of determining the frequency distribution of a signal.

**Spectrum Analyzer**

A device for determining the frequency components of a signal.

**Spectrum Length**

The amount of time required to acquire one frame.

**Spurious Response**

A response to a spectrum analyzer wherein the displayed frequency is not related to the input frequency.

**Vertical Scale Factor, Vertical Display Factor**

The number of dB, volts, etc., represented by one vertical division of a spectrum analyzer display screen.

**View**

An area or window of the display screen which contains information all of the same type (such as a Spectrum View or a Power versus Time View).





# Index



# Index

## A

- A/D overflow, 3–75
- AC line frequency, 1–10
- Accessories, E–1
  - optional, E–3
  - standard, E–3
- ACPR measurement, 3–7
- Acquisition
  - history, 3–86
  - length, 3–86
- AM signal measurement, 3–36
- Amplitude
  - correction, 3–76
  - menu, 3–71, 3–72
  - setting, 3–71
- Analog modulation analysis, 3–34
  - basic procedure, 3–34
- Analysis
  - length, 3–86
  - offset, 3–86
- Analysis range, setting, 3–29
- Angular units, System menu, 2–23
- Architecture, 1–6
- Arrow keys, Markers menu, 3–141
- Auto level, 3–72
- Average, 3–113
  - Demod mode, 3–116
  - menu, 3–114
  - Time mode, 3–116
  - type, 3–117

## B

- Backing up user files, 1–20
- Bin, relation between frame, bin, and pixel, 3–120
- Block diagram, 1–6
- Brightness
  - adjusting, 1–26
  - uneven, 1–19

## C

- C/N measurement, 3–9
- Cal menu, 1–22
- Calibration, 1–21
- Carrier frequency measurement, 3–13
- Caution, RF INPUT, 1–12
- CCDF

- Time mode, 3–48
  - view setting, 3–130
- Center offset calibration, 1–24
- Changing, overview, 3–32
- Channel power measurement, 3–5
- Channel table, using, 3–66
- Characteristics
  - electrical, A–2
  - environmental, A–13
  - physical, A–13
- Cleaning, D–1
- Compression, trace data, 3–120
- Continuous, trigger, 3–93
- Conventions, xvi
- Copy, screen, 3–181
- Correction, amplitude
  - description, 3–76
  - menu, 3–77

## D

- DC offset calibration, 1–25
- Default settings, C–1
  - restoring, 2–22
- Demod mode, 3–27
- Difference between RSA2203A and RSA2208A, 1–2
- Dimensions, A–13
- Display, dead pixel, 1–19
- Display line, 3–131
  - multi display lines (Real Time S/A only), 3–135
  - operation, 3–132
- Documentation list, xvi

## E

- EBW measurement, 3–14
- Electrical characteristics, A–2
- Environmental characteristics, A–13
- Ethernet connector, side panel, 2–5
- Extended Res, 3–105
- External trigger input, specification, A–10

## F

- Features, 1–1
- FFT
  - description, 3–103
  - Extended Res., 3–105

- menu, 3-104
- overlap, 3-106
- points, 3-107
- window, 3-108

File

- data file format, 3-169
- entering a name, 3-166
- format, 3-169
- loading, 3-160
- operation, 3-157
- saving, 3-160
- trace file format, 3-177
- type, 3-157

Floppy disk

- drive, side panel, 2-5
- using, 3-160

FM signal measurement, 3-37

Frame, relation between frame, bin, and pixel, 3-120

Free Run, trigger mode, 3-93

Frequency

- menu, 3-64
- setting, 3-63

Frequency versus Time measurement, 3-47

FREQUENCY/CHANNEL, 3-64

Functional check, 1-14

## G

- Gain calibration, 1-23
- General purpose knob, 2-3

## H

- Hard copy, screen, 3-181
- Help, menu, 3-151
- How to adjust
  - center offset, 1-24
  - DC offset, 1-25
  - display brightness, 1-26
  - gain, 1-23
- How to create
  - amplitude correction files, 3-79
  - directory, 3-168
  - files, 3-183
- How to delete
  - directories, 3-168
  - files, 3-168
- How to display
  - averaged waveforms, 3-118
  - data by trigger and repeat modes, 3-96
  - horizontal display line, 3-133
  - multiple views, 3-124

- online help, 3-151
- options, 2-24
- trace 1 and 2, 3-116
- trigger point, 3-101
- versions, 2-24
- vertical display line, 3-134
- Windows desktop, 2-26

How to enter

- file name, 3-166
- numeric data, 2-17

How to install

- keyboard, 2-6
- mouse, 2-6
- printer driver, 3-182
- USB printer connection, 3-182

How to load

- files, 3-160
- menu settings, 3-160
- trace, 3-120

How to save

- amplitude correction table, 3-76, 3-157
- data to a PC via a network, 2-5
- files, 3-160
- menu settings, 3-160
- preset files, 3-161
- screen copy to a disk, 3-183
- trace, 3-120

How to set, zoomed area, 3-25

## I

- IF trigger, 3-98
- Input
  - menu, 3-155
  - over-voltage, 3-75
  - source, 3-155
- Inspection, D-1
- Installation, 1-9
- Interface, maps, 2-1
- IQ, IQ versus Time measurement, 3-40, 3-45

## K

- Key, lock, 2-11
- Keyboard, operation, 2-7
- Keypad, 2-3
  - entering a file name, 3-166
  - using, 2-19

**L**

- LAN Ethernet connector, side panel, 2–5
- Lines
  - menu, 3–132
  - menu (Real Time S/A), 3–136
- Load, menu, 3–158

**M**

- Main view, modulation analysis screen, 3–28
- Manuals list, xvi
- Map, interface, 2–1
- Marker
  - menu, 3–140
  - operation, 3–139
- MARKER SETUP, 3–142
- Max Hold, description, 3–117
- Meas Setup menu
  - FM Demod measurement, 3–37
  - PM Demod measurement, 3–39
  - pulse measurement, 3–60
- Measurement, mode, 2–21
- Measurements
  - ACPR, 3–7
  - AM demod, 3–36
  - analog modulation analysis, 3–34
  - C/N, 3–9
  - carrier frequency, 3–13
  - CCDF, 3–48
  - channel power, 3–5
  - EBW, 3–14
  - FM demod, 3–37
  - frequency versus time, 3–47
  - IQ versus time, 3–40, 3–45
  - modulation analysis (Demod mode), 3–27
  - OBW, 3–11
  - PM demod, 3–39
  - power versus time, 3–46
  - pulse, 3–53
  - pulse spectrum, 3–41
  - real-time analysis, 3–20
  - spectrum analysis (S/A mode), 3–1
  - spurious signal, 3–16
  - time analysis (Time mode), 3–43
- Menu
  - Amplitude, 3–71
  - amplitude correction, 3–77
  - Average, 3–114
  - basic operation, 2–16
  - FFT, 3–104
  - Frequency, 3–64

- front panel keys, 2–3
- Help, 3–151
- Input, 3–155
- Lines, 3–132
- Lines (Real Time S/A), 3–136
- Load, 3–158
- Markers, 3–140
- Print, 3–181
- RBW, 3–104
- Save, 3–158
- Span, 3–64
- System, 2–23
- Timing, 3–85
- Trace, 3–114
- tree, B–1
- Trigger, 3–92
- View, 3–123
- Min Hold, description, 3–117
- Minimum jump, setting, 3–149
- Mode, selecting, 2–21
- Modulation analysis (Demod mode), 3–27
- Mouse, operation, 2–7
- Mult display lines (Real Time S/A only), 3–135

**N**

- NBW, setup display, 2–12
- Numeric input, 2–17

**O**

- OBW measurement, 3–11
- Online help, using, 3–151
- Option, displaying, 2–24
- Option key, 2–25
- Optional accessories, E–3
- Options, E–1
- Overflow, A/D, 3–75
- Overlap, FFT, 3–106
- Overview
  - changing, 3–32
  - modulation analysis screen, 3–28
- Over-voltage input, 3–75

**P**

- PEAK, 3–141
- Peak search, 3–139
  - operation, 3–148
  - setting minimum jump, 3–149
- Physical characteristics, A–13

Pixel, relation between frame, bin, and pixel, 3–120  
 PM signal measurement, 3–39  
 Power  
   AC requirements, 1–10  
   connecting the cord, 1–10  
 Power switch, 1–11  
 Power versus Time measurement, 3–46  
 Powering off, 1–18  
 Powering on, 1–10, 1–11  
 PRESET, 2–22  
 Principal power switch, 1–11  
 Print  
   menu, 3–181  
   screen copy, 3–181  
 Product description, 1–1  
 Pulse measurements, 3–53  
 Pulse spectrum, 3–41

## R

RBW  
   description, 3–103  
   menu, 3–104  
 Real Time S/A, operation, 3–20  
 Real-time analysis, 1–3  
   S/A mode, 3–20  
 Rear panel, 2–4  
 Repeat, trigger, 3–93  
 Restart, 1–19  
 RF INPUT, Caution, 1–12  
 RMS, description, 3–117  
 RMSE<sub>expo</sub>, description, 3–117  
 RUN/STOP key, 2–22

## S

S/A mode, 3–1  
 S/A with Spectrogram, operation, 3–18  
 Save, menu, 3–158  
 Save on trigger, 3–97  
 Scalar mode, span, 3–70  
 Scale menu  
   CCDF, 3–130  
   spectrogram, 3–126  
   spectrum, 3–125  
   time domain view, 3–128  
 Scan Disk, 1–19  
 Screen, elements, 2–8  
 Screen copy, 3–181  
 Seamless acquisition, 3–89  
 SELECT, MARKERS, 3–141  
 Setting, analysis range, 3–29

Setup, display, 2–12  
 Side keys, 2–3  
 Side panel, 2–5  
 Signal amplitude limit, 1–12  
 Signal processing , 1–6  
 Single, trigger, 3–93  
 Single view, 3–33  
 SPAN, 3–65  
 Span  
   menu, 3–64  
   setting, 3–63  
   vector span, 3–70  
 Specifications, A–1  
 Spectrogram  
   S/A with Spectrogram, 3–18  
   view setting, 3–126  
 Spectrum  
   analysis, S/A mode, 3–1  
   length, 3–86  
   offset, 3–87  
   view setting, 3–125  
 Spurious signal measurement, 3–16  
 Stand, setting up, 1–13  
 Standard accessories, E–3  
 Status, display, 2–10  
 Step size  
   center frequency, 2–20  
   setting, 2–20  
 Stop and Show Results, 3–94  
 Subview, modulation analysis screen, 3–28  
 System menu, 2–23

## T

Time analysis (Time mode), 3–43  
 Time domain, view setting, 3–128  
 Time variation measurement, 3–44  
   basic procedure, 3–44  
 Timing, menu, 3–85  
 Timing menu, zoom, 3–24  
 Trace  
   comparison, 3–113  
   displaying, 3–116  
   menu, 3–114  
   saving/loading, 3–120  
 Trigger, 3–91  
   IF trigger, 3–98  
   level, 3–94  
   menu, 3–92  
   mode, 3–93  
   position, 3–95  
   save on trigger, 3–97

slope, 3–95  
source, 3–94  
specification, A–10  
trigger output, indicating, 3–101  
trigger point indicator, 3–101  
Triggered, trigger mode, 3–93  
Troubleshooting, 1–19  
Tutorial, 2–29

## U

UNCAL, 1–12  
Unpacking, 1–9  
USB connectors, side panel, 2–6

## V

Vector mode, span, 3–70

Vector span, 3–70  
Version, displaying, 2–24  
VGA output connector, side panel, 2–6  
View  
    menu, 3–123  
    setting, 3–123

## W

Windows XP, using, 2–26

## Z

Zoom  
    function, 3–24  
    setting a zoomed area, 3–25  
    Timing menu, 3–24

